

Installation manual

Montageanleitung • Notice de montage • Istruzioni per il montaggio
Manual de montaje • Monteringsanvisning • Installatiegids • Asennusohje • Installationsmanual

Element house ELU18-4555-1

Elementhaus • Maison à modules • Casetta in elementi • Cobertizo • Redskapsbod • Element huis • Elementti piharakennus • Friggebod

Width 448 x Depth 548 cm

Breite/Tiefe • Largeur/Profondeur • Lunghezza/Profondità • Ancho/Profundidad • Bredde/Dybde • Breedte/Diepte • Leveys/Pituus • Bredd/Längd

Log thickness 18 mm

Bohlenstärke • Épaisseur des murs • Spessore delle pareti • Grosor de pared • Tykkelse • Wanddike • Seinän paksuus • Väggtjocklek



The producer shall have the right to make technical changes to the product • Technische Änderungen vorbehalten • Le producteur réserve le droit d'effectuer des modifications techniques au produit • Il produttore mantiene il diritto di apportare modifiche tecniche al prodotto • Reservado el derecho a modificaciones técnicas • Produsent forbeholder seg retten til å endre tekniske egenskaper ved produktet • Alle rechten en technische wijzigingen voorbehouden • Valmistaja pidättää oikeuden tehdä tuotteeseen teknisiä muutoksia • Tillverkaren har rätt att utföra tekniska förändringar för produkten

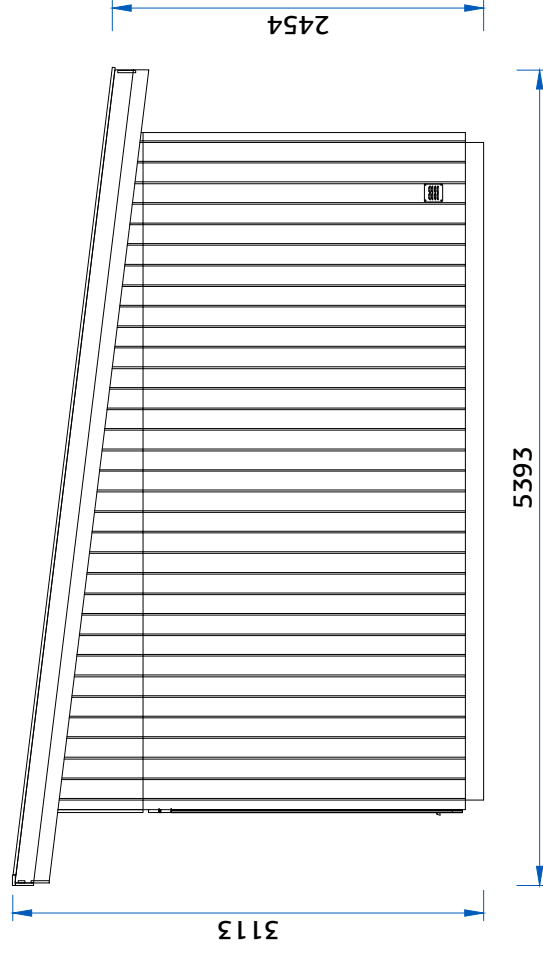
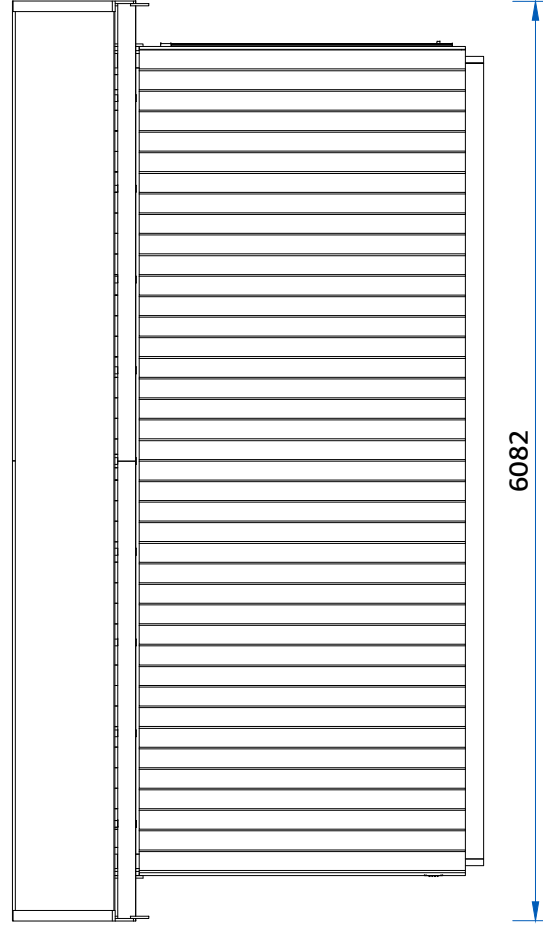
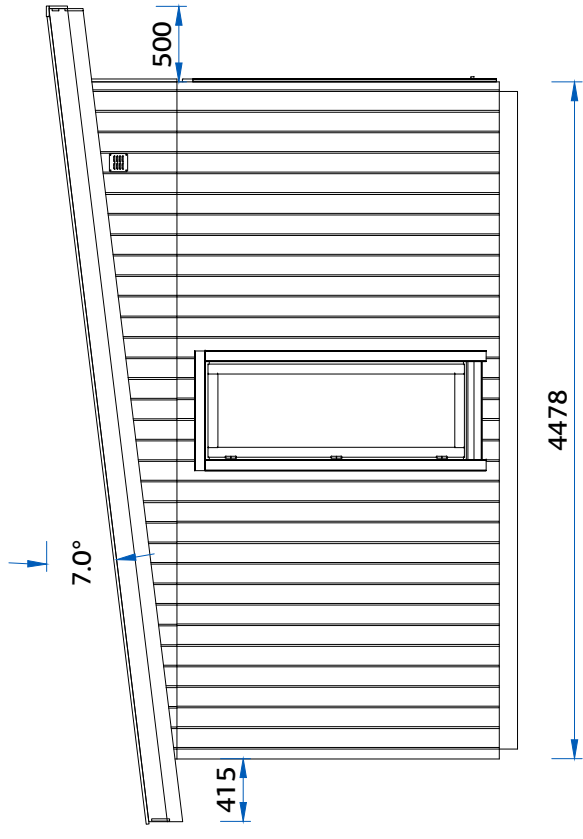
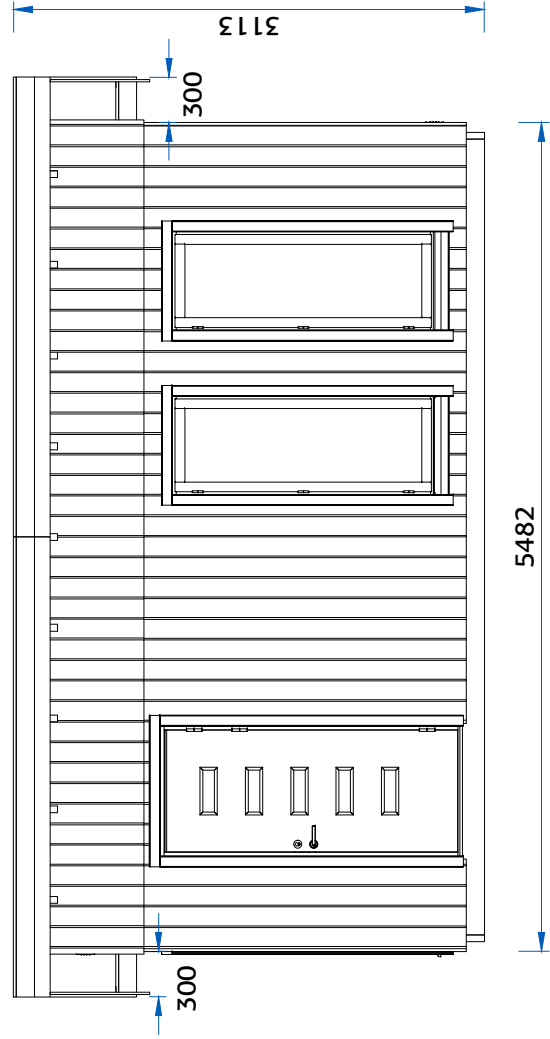

Object name

ANNIKA 21.5

Drawing

Vaated

Scale

1:50

Paper

A3

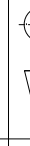

Page

1

AS Palmako
Näsiluise 25, Tartu 50009, Estonia
tel. +372 73 55 550
fax. +372 73 55 544
www.palmako.com

Palmako
LEHETS GROUP

Log

Customer

007

Drawn by



007







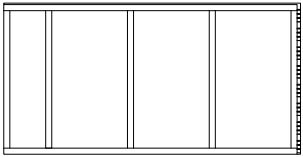
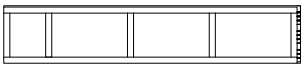
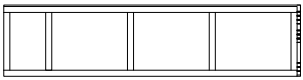

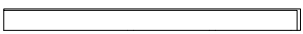
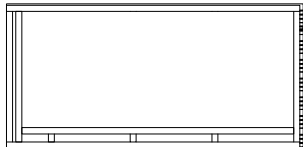
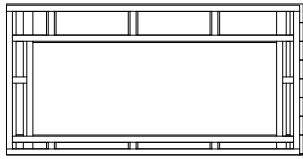
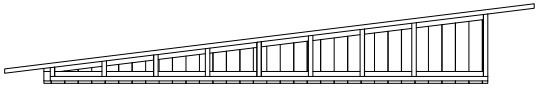
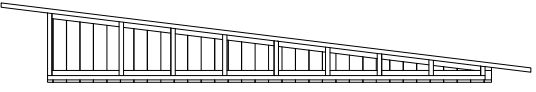
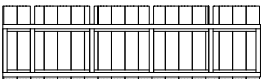
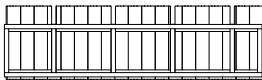
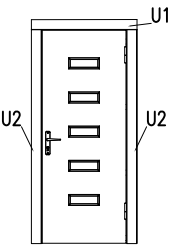
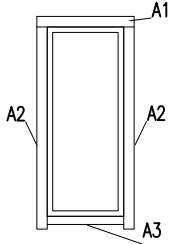











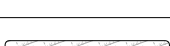

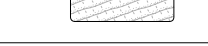
Date

27.11.2017

File

Annika 21.5.dwg

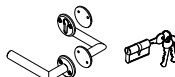
EL1		2155 x 1097 x 160	11
EL2		2155 x 417 x 160	4
EL3		2155 x 543 x 160	2
EL4		2155 x 169 x 65	2
EL5		2155 x 160 x 74	2
EL6		2155 x 1097 x 160	1
EL7		2155 x 1097 x 160	3
EL8		5342 x 825 x 160	1
EL9		5342 x 825 x 160	1
EL10		2609 x 765 x 160	1
EL11		2599 x 765 x 160	1
U105-15-920R	 <p>U1 – 19x40x1050 2 pcs U2 – 19x70x2000 4 pcs</p>	870 x 1985 x 105	1
A105-4R	 <p>A1 – 19x70x850 2 pcs A2 – 19x70x1900 4 pcs A3 – 19x70x700 2 pcs</p>	660 x 1740 x 105	3

1		Impregnated	45 x 145 x 5262	10
2		Impregnated	45 x 145 x 4348	2
3			19 x 89 x 4153	58
4			44 x 95 x 5198	1
5			45 x 195 x 5397	9
6			19 x 89 x 3625	61
7			19 x 89 x 2425	61
8			32 x 40 x 5376	2
9			16 x 120 x 5500	4
10			19 x 70 x 5380	2
11			19 x 70 x 3041	2
12			16 x 120 x 3041	6
13			16 x 45 x 3041	2
14			19 x 70 x 2200	10
15			18 x 145 x 765	3
16			10 x 192 x 576	16
17			10 x 192 x 282	4
F1			70 x 70 x 55	18
F2			Ø 6 x 120	40
F3			Ø 5 x 90	230
F4			Ø 4.5 x 50	320
F5			Ø 4 x 40	220
F6			Ø 2,2 x 50	1300
F7			QULink/ASSA QULSydamik/ASSA QULSydamikkate/ASSA	1 set
F8		QKR4_5x25YZn	Ø 4.5 x 25	8
F9			140x140toruga	2

1

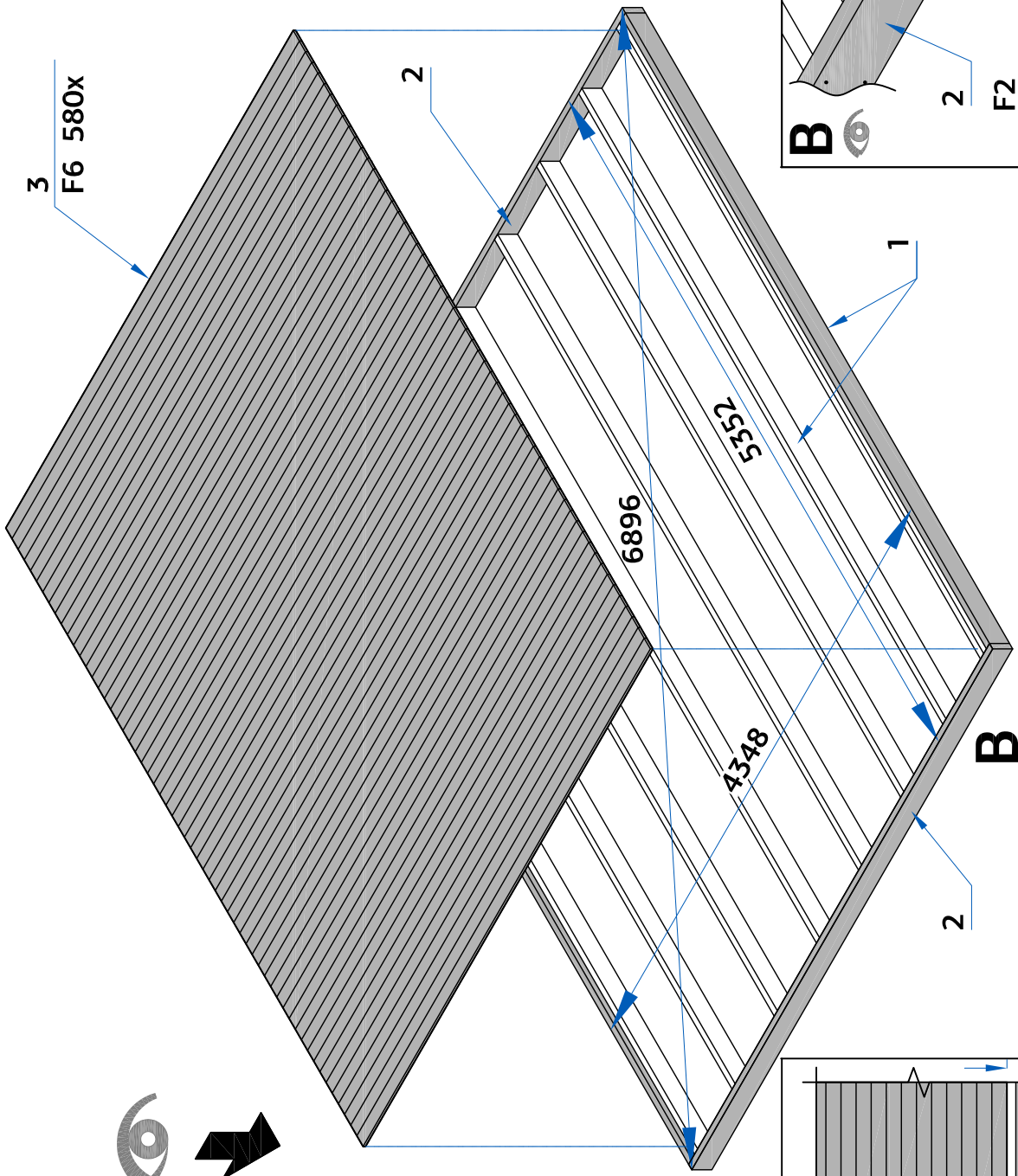
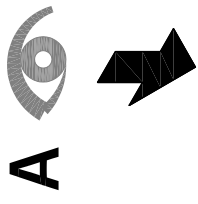

3
F6 580x

2

6896

5352

4348

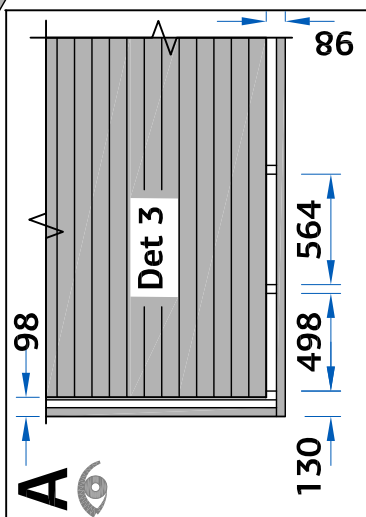

A

98

Det 3

564

498

130

86

B

130 mm

2

F2

40x

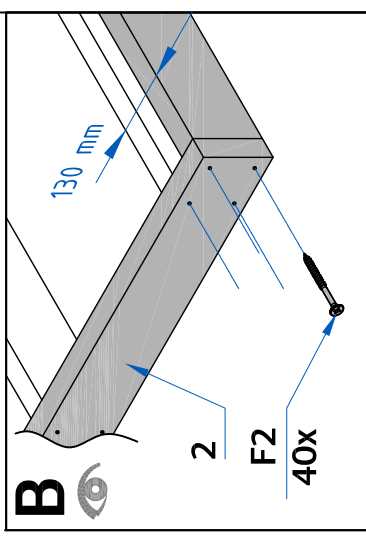

2

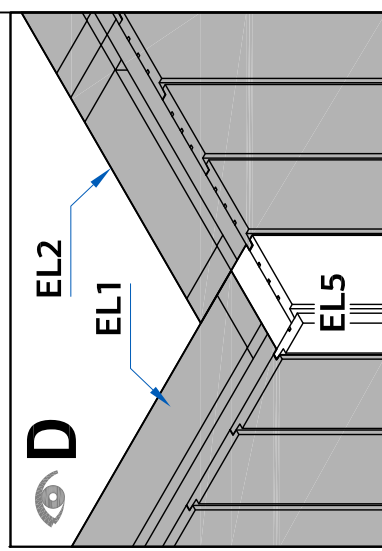
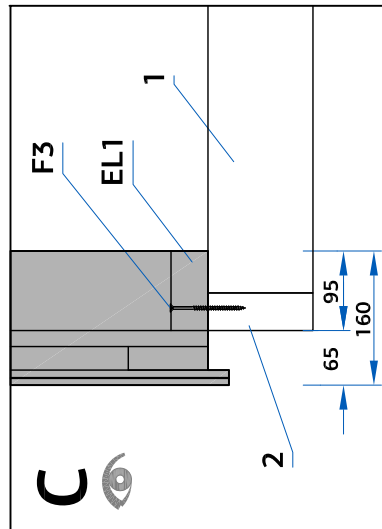
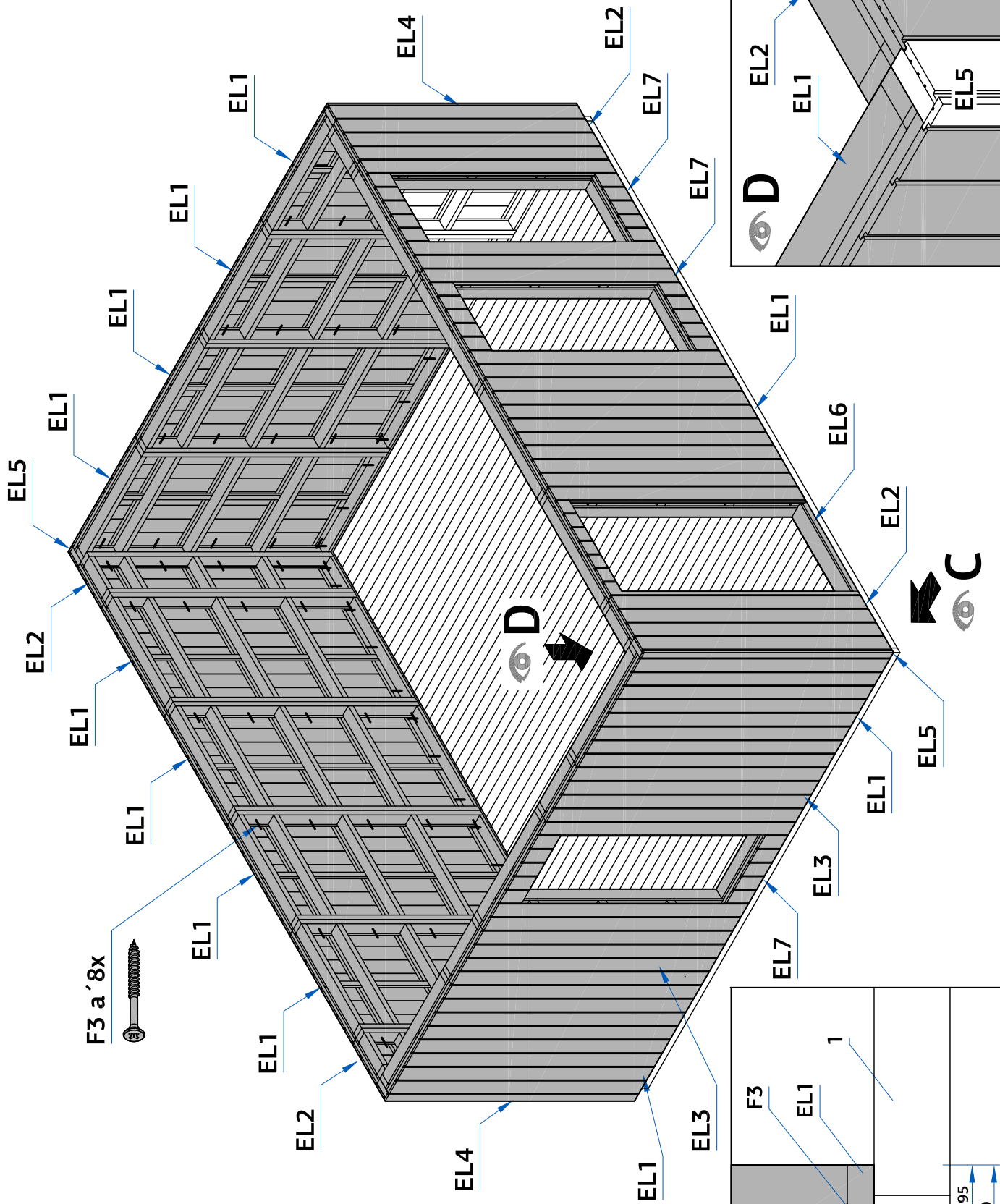

3

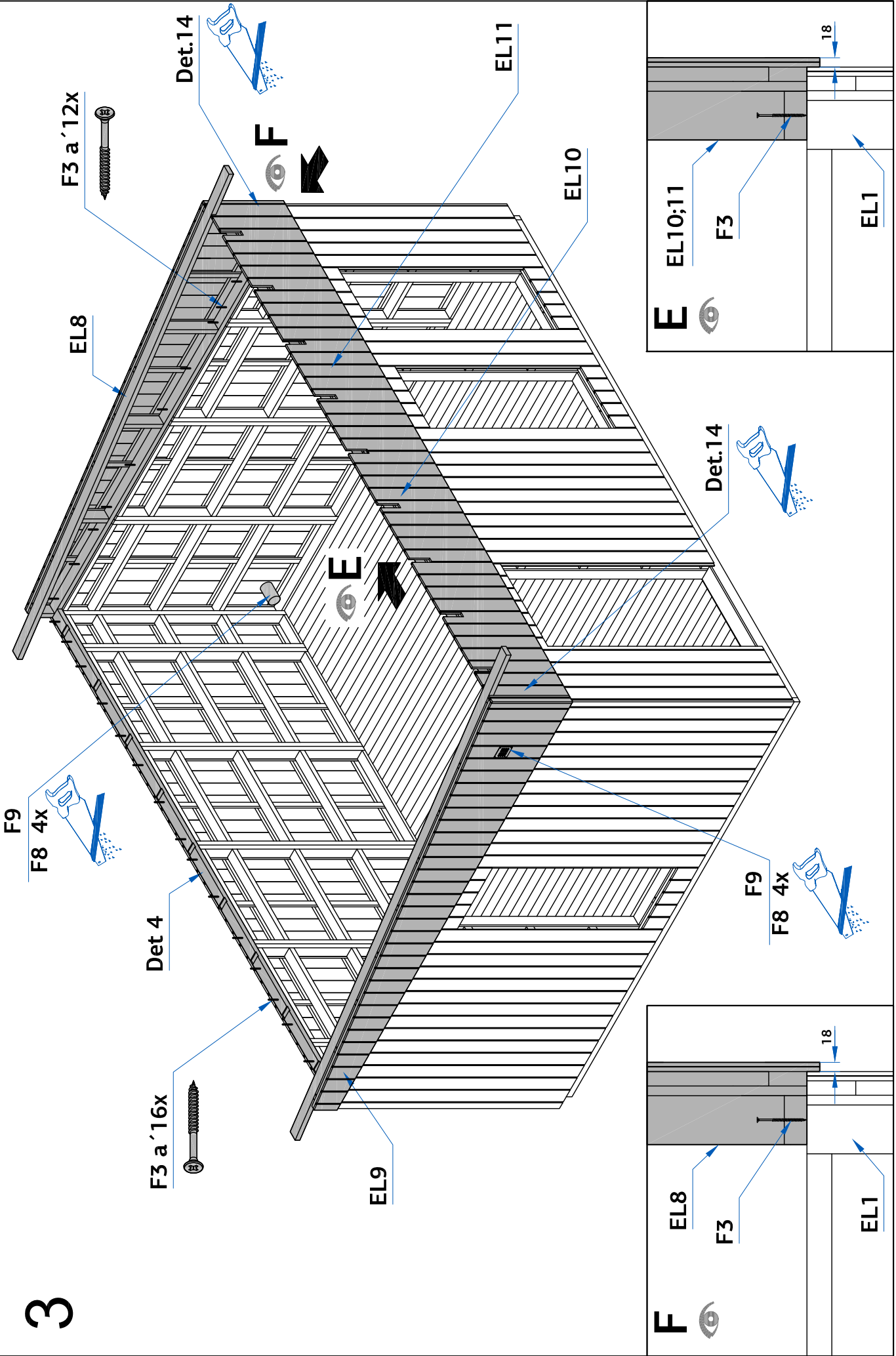

4

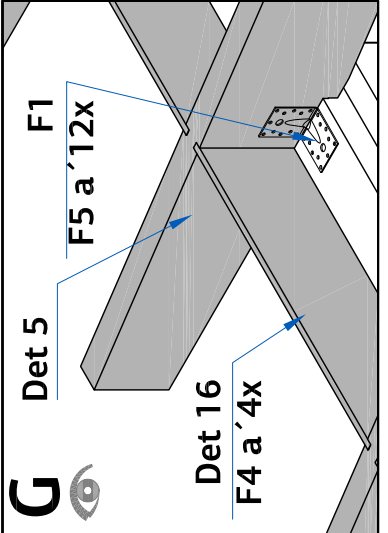
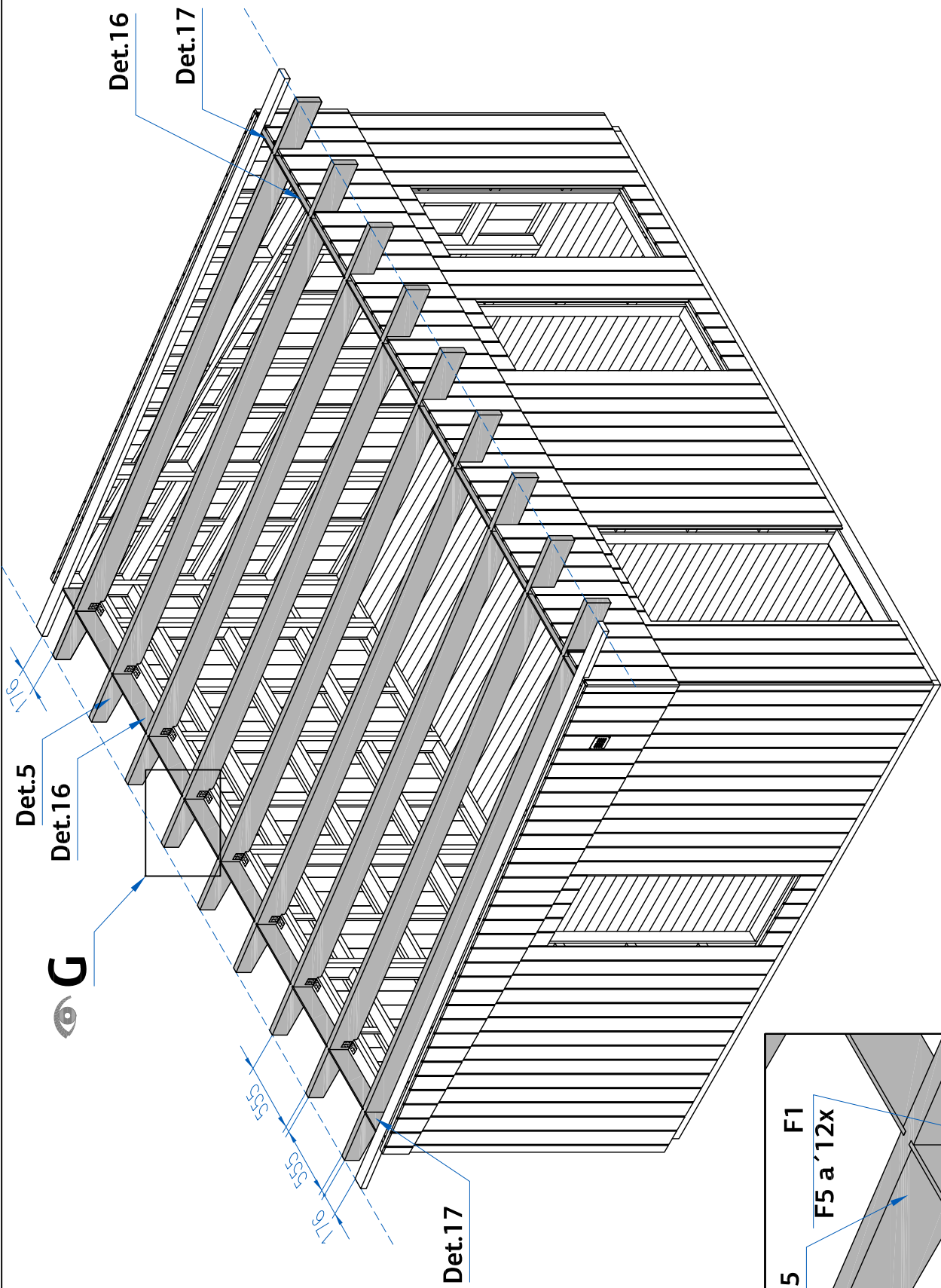

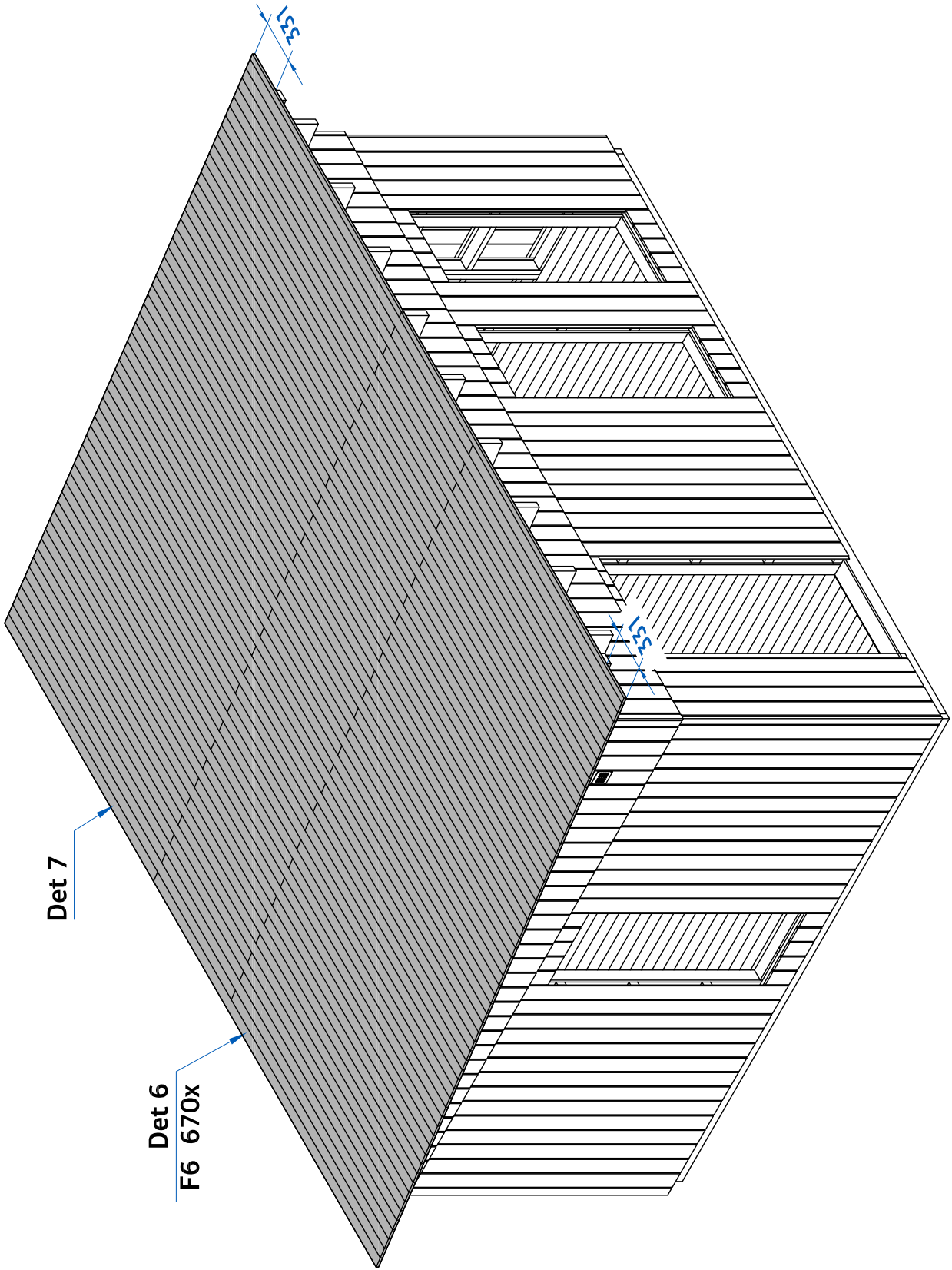

6

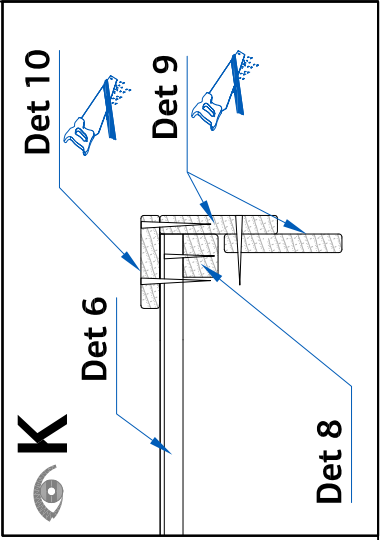
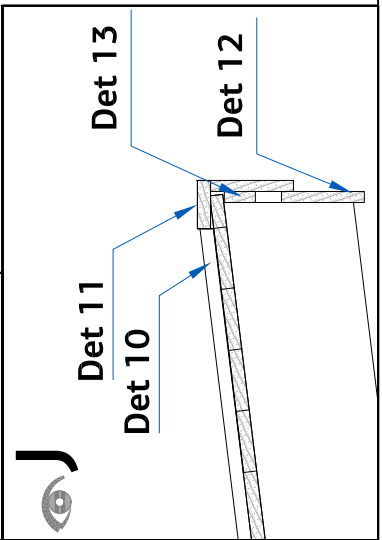
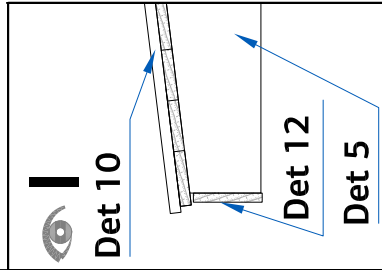
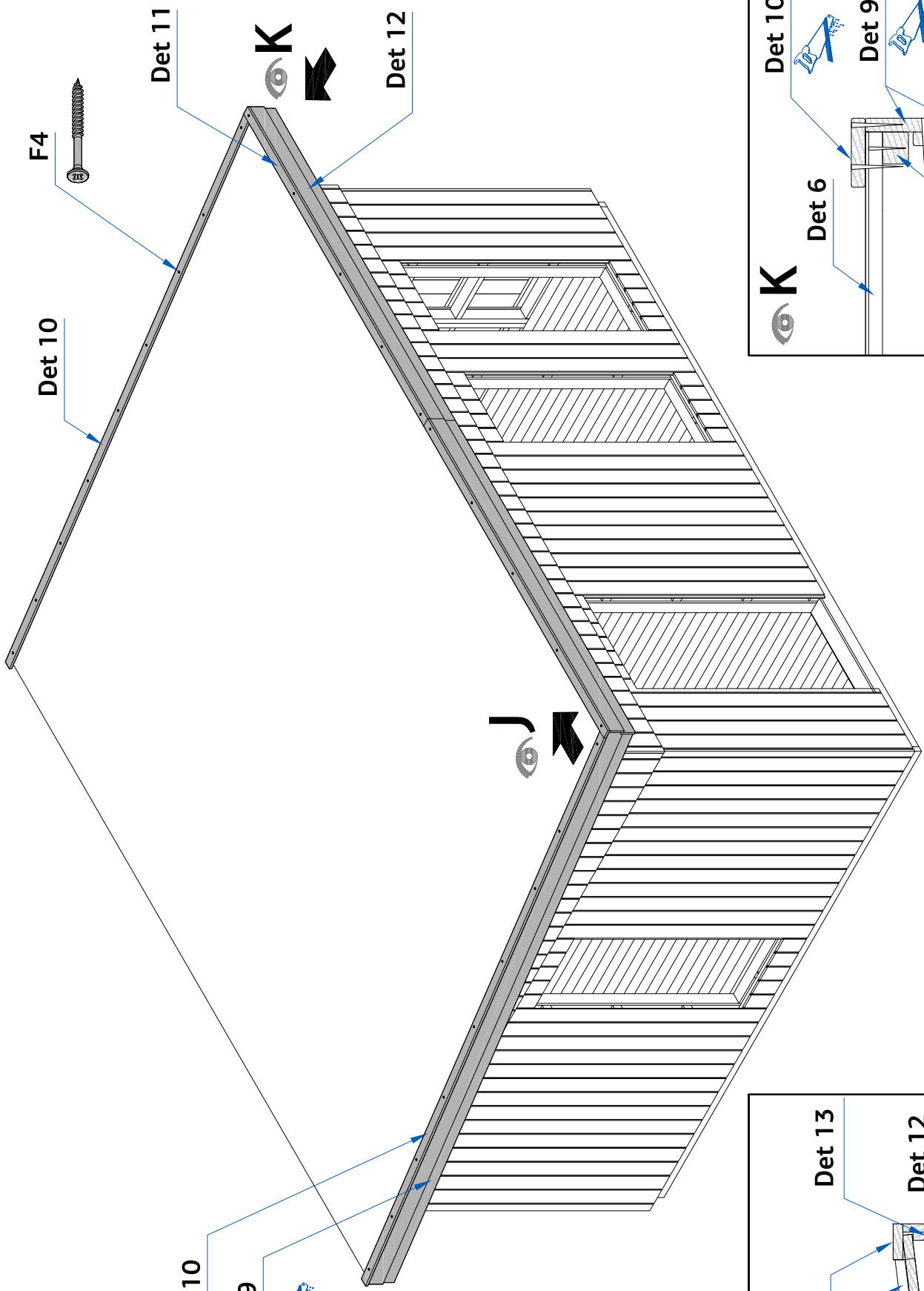

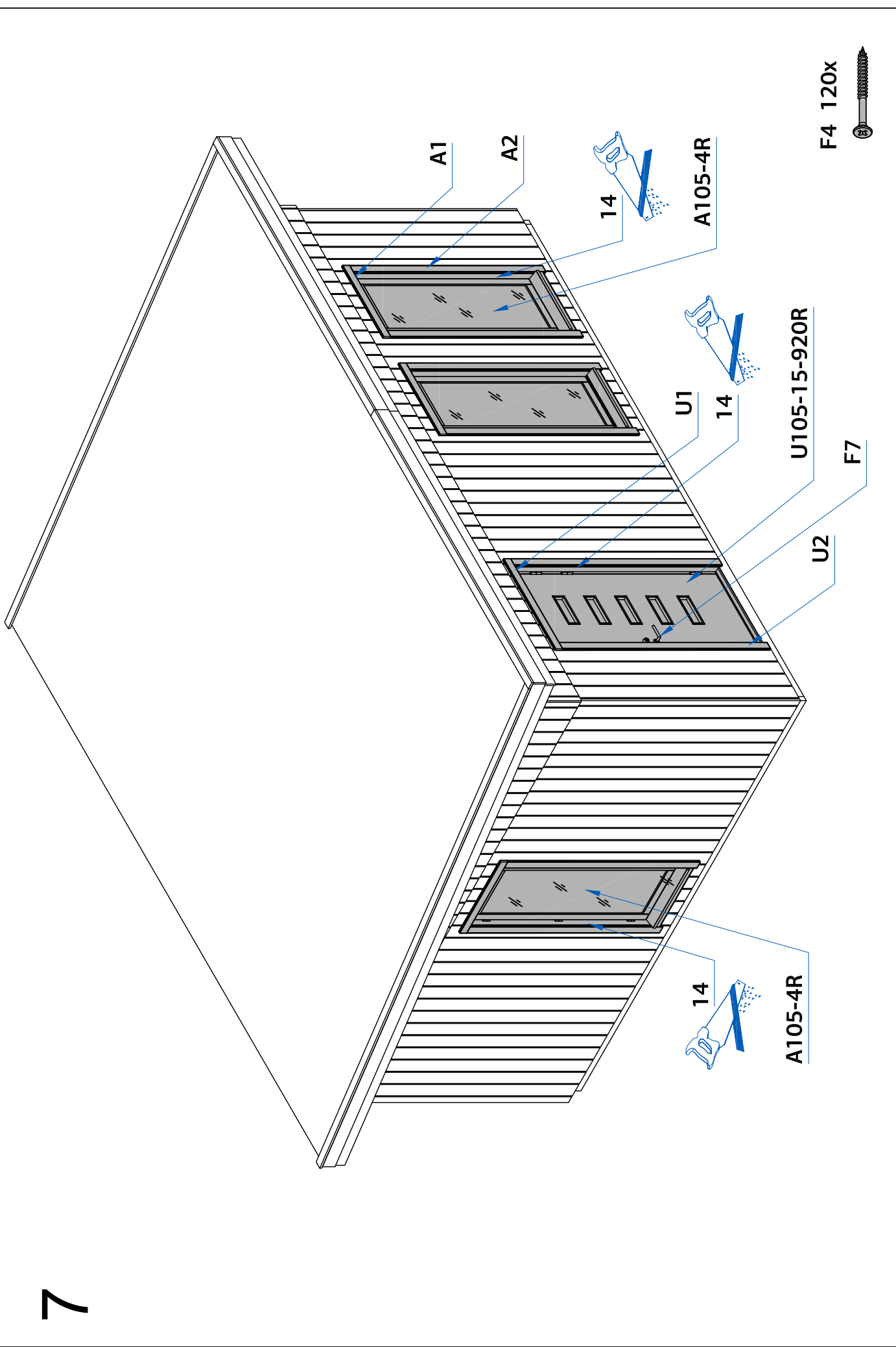

F4 120x 

A105-4R

U105-15-920R

A105-4R

A1

A2

U1

U2

F7

14 

14 

14 

1 General information



Dear client,

We are glad that you have decided in favour of our garden house!

Please read the assembly manual carefully before proceeding with the house installation! You will thus avoid problems and will not waste time.

Recommendations:

- Keep the house package until its complete assembly in a dry place, but not in direct contact with the ground, protected from weather conditions (moisture, the sun, etc.). Do not keep the house package in a heated room!
- When selecting the garden house location, make sure that the house will not be subjected to extreme weather conditions (areas of strong snowfall or winds); otherwise you should attach the house (for instance, with anchors) to the subsoil.



Warranty

Your house is made from high quality fir and delivered in the natural (unprocessed) form. If, despite our thorough inspection, you should have complaints, please submit the filled out control sheet and purchase invoice to the product seller.

ATTENTION: Please be sure to keep the documentation accompanying the house package! The control sheet includes the control number of the house. We can only review complaints if you submit the control number of the house to the seller!

The warranty does not cover:

- Peculiarities of wood as a natural material
- Wooden details already painted (processed with a wood preservative)
- Wooden details containing whole branches that do not endanger the stability of the house
- Colour tone variations caused by wood structure differences that do not influence wood lifetime
- Wooden details containing (caused by drying) small cracks/gaps that do not pass through and do not influence the structure of the house
- Twisted wooden details if they can nevertheless be installed
- Roof and floor boards that may have on their concealed surfaces some non-planed areas, colour differences and waning
- Complaints resulting from an incompetent manner of the installation of the house or the house subsiding due to an incompetently made foundation
- Complaints caused by introducing self-initiative changes to the house, such as the deformation of wooden details and doors/windows due to an incompetent manner of wood processing; the attachment of storm braces too rigidly, doorframes being screwed onto wall logs, etc.

The complaints covered by the warranty are satisfied to the extent of replacing the deficient/faulty material. All other demands will be excluded!



Garden house painting and maintenance

Wood is a natural material, growing and adapting depending on weather conditions. Large and small cracks, colour tone differences and changes, as well as a changing structure of wood are not errors, but a result of wood growing and a peculiarity of wood as a natural material.

Unprocessed wood (except for foundation joists) becomes greyish after having been left untouched for a while, and can be turn blue and become mouldy. To protect the wooden details of your garden house, you must immediately process them with a wood preservative.

We recommend that you cover the floor boards in advance with a colourless wood impregnation agent, especially the bottom sides of the boards, to which you will no longer have access when the house is assembled. Only this will prevent moisture penetration.

We definitely recommend that you also process the doors and windows with a wood impregnation agent, and do that namely both inside and outside! Otherwise the doors and windows can become twisted.

After the house assembly is completed, we recommend for the conclusive finishing a weather protection paint that will protect wood from moisture and UV radiation.

When painting, use high quality tools and paints, follow the paint application manual and manufacturer's safety and usage instructions. Never paint a surface in strong sunlight or rainy weather. Consult a specialist regarding paints suitable for unprocessed softwood and follow the paint manufacturer's instructions.

Having been properly painted, your garden house's lifetime will increase substantially. We recommend that you inspect the house thoroughly once every six months.

2 Preparation for assembly

Tools and preparation of components

To assemble the garden house, you will need the following tools:



assembly aid



ladder



hammer



water-level



screwdriver



saw



knife



measuring tape



pliers



drill

ADVICE: To avoid splinters, we recommend that you wear the corresponding protective gloves during the assembly process.



We wish you total success with the garden house installation and much joy with this house for many years to come!

1 Generelles



Sehr geehrter Kunde,

es freut uns, dass Sie sich für unser Gartenhaus entschieden haben!

Es ist wichtig, diese Aufbauanleitung vollständig durchzulesen, bevor Sie mit dem Aufbau Ihres Blockhauses beginnen! So vermeiden Sie Probleme und unnötigen Zeitverlust.

Tipps:

- Lagern Sie den Bausatz bis zur endgültigen Montage trocken und nicht direkt auf dem Erdboden, geschützt vor Witterungseinflüssen (Nässe, Sonneneinwirkung, etc.). Ware bitte nicht in einem geheizten Raum aufbewahren!
- Achten Sie bei der Standortwahl darauf, dass das Blockhaus nicht extremen Witterungsbedingungen (Gebiete mit starkem Wind) ausgesetzt ist, gegebenenfalls sollten Sie das Blockhaus zusätzlich mit dem Fundament verankern.



Gewährleistung

Ihr Haus besteht aus hochwertigem nordischen Fichtenholz und wird unbehandelt geliefert. Wenn es trotz unserer sorgfältigen Werkskontrolle zu Reklamationen kommen sollte, legen Sie Ihrem Fachhändler den ausgefüllten Kontrollschein mit Ihrer Einkaufsrechnung vor!

WICHTIG: Bitte unbedingt die Dokumentation aufbewahren! Auf dem Kontrollschein finden Sie die Kontrollnummer des Hauses. Es ist möglich die Reklamation nur dann als Garantiefall zu behandeln, wenn Sie die Kontrollnummer Ihrem Fachhändler weitergeben!

Abweichungen die keinen Reklamationsgrund darstellen:

- Holz ist ein Naturprodukt, daher gehören die naturgegebenen Beanstandungen nicht unter Garantie.
- Materialreklamationen werden nicht akzeptiert, wenn bereits ein Anstrich erfolgte!
- Äste die mit dem Holz fest verwachsen sind.
- Holzverfärbungen, ohne das dadurch die Lebensdauer beeinflusst wird.
- Risse /Trockenrisse die nicht durchgehend sind und nicht die Konstruktion beeinflussen.
- Verdrehungen des Holzes vorausgesetzt es lässt sich noch verarbeiten.
- An den nicht sichtbaren Seiten von Dach- und Fussbodenbrettern können die Bretter ungehobelt sein, es können Farbunterschiede und Baumkanten vorkommen.
- Spätere Reklamation durch unsachgemässe Montage, Absacken des Hauses durch unsachgemässe Fundamente und Gründungen sind ausgeschlossen.
- Eigene Veränderungen am Haus wie z.B. Verzug von Bohlen und Fenstern/Türen durch fehlenden Holzanstrich oder Aufbau, die zu starre Befestigung der Sturmleiste, Verschrauben der Türrahmen mit den Blockbohlen usw., sind ausgeschlossen.

Ansprüche auf Gewährleistung beschränken sich auf den Austausch von fehlerhaftem Material. Alle weiteren Ansprüche sind ausgeschlossen!



Anstrich und Pflege

Holz ist ein Naturprodukt und arbeitet unterschiedlich. Merkmale wie grobe und feine Maserungen, Farbschattierungen und Veränderungen sowie Verwachsungen haben Ihren Ursprung im Wuchs des Baumes. Sie sind bei Hölzern, die in der freien Natur wachsen, normal und deshalb nicht als Fehler, sondern vielmehr als Eigentümlichkeit des Naturwerkstoffes Holz anzusehen.

Das unbehandelte Holz (ausser Lagerhölzer) wird nach einiger Zeit vergrauen, kann verbläuen und verschimmeln. Um ihr Blockhaus zu schützen, sollten Sie es mit geeigneten Holzschutzmitteln behandeln.

Um Ihr Gartenhaus optimal zu schützen, empfehlen wir die Bodenbretter vorgängig mit einer farblosen Grundierung zu behandeln. Besonders die Unterseite, welche nach der Montage nicht mehr zu erreichen ist. Nur auf diese Weise wird das Eindringen der Feuchtigkeit verhindert.

Wir empfehlen unbedingt auch Türen und Fenster mit einer Grundierung zu behandeln. Es ist sehr wichtig sowohl die Innen- als auch die Aussenseiten der Türen und Fenster auf einmal zu streichen! Andernfalls können sie sich verziehen.

Nach dem Aufbau empfehlen wir Ihnen die Aussenhaut (ohne Dach) zu Grundieren, sobald diese trocken ist sollten Sie das Haus mit einer Holzlasur streichen, die das Holz vor Feuchtigkeit und UV-Strahlung schützt.

Beim Anstrich benutzen Sie hochwertiges Werkzeug und Farbe, beachten Sie die Sicherheits- und Verarbeitungshinweise des Farbenherstellers. Streichen Sie nie in praller Sonne oder beim regnerischen Wetter. Lassen Sie sich ausführlich bei Ihrem Fachhändler über den Holzschutz für unbehandelte Nadelhölzer beraten.

Durch einen regelmässigen Anstrich beeinflussen Sie im Wesentlichen die Lebensdauer Ihres Gartenhauses. Wir empfehlen Ihnen auch eine halbjährliche Inspektion des Gartenhauses.

2 Vorbereitung zur Aufbau

Werkzeuge und Vorbereitung der Details

Beim Aufbau brauchen Sie Folgendes:



Montagehelfer



Stehleiter



Hammer



Wasserwaage



Schraubenzieher



Säge



Messer



Bandmass



Zange



Bohrer

HINWEIS: Um Verletzungen durch eventuelle Holzsplitter zu vermeiden, tragen Sie bitte während der Montage entsprechende Schutzhandschuhe.



Wir wünschen Ihnen nun viel Spass und Erfolg beim Aufbau und jahrelange Freude mit Ihrem Gartenhaus!

1 Généralités



Cher client,

Nous sommes heureux que votre choix se soit porté sur notre maison de jardin!

Il est important de lire entièrement cette notice de montage avant de commencer la construction de votre maisonnette en poutres! Vous vous éviterez ainsi des problèmes et des pertes de temps inutiles.

Conseils:

- Avant son montage définitif, entreposez le kit de construction au sec et pas directement sur la terre, en le protégeant contre les intempéries (humidité, rayonnement du soleil, etc.). Ne pas conserver la marchandise dans un local chauffé!
- Au moment de choisir l'endroit de montage, veillez à ce que la maisonnette en poutres ne soit pas exposée à des conditions atmosphériques extrêmes (zones exposées à des vents forts). Le cas échéant, il serait bon d'ancrer la maisonnette en poutres dans des fondations.



Garantie

Votre maisonnette est réalisée en bois d'épicéa nordique de haute qualité et elle vous est livrée non traitée. Si elle devait donner lieu à des réclamations, malgré les soins apportés à notre contrôle en usine, nous vous demandons de remettre à votre revendeur spécialisé le bon de contrôle rempli et votre facture d'achat!

IMPORTANT: Veuillez impérativement conserver la documentation! Vous trouverez sur le bon de contrôle le numéro de contrôle de la maisonnette. La réclamation ne peut être traitée dans le cadre de la garantie que si vous communiquez le numéro de contrôle à votre revendeur spécialisé!

Ecartis qui ne constituent pas un motif de réclamation:

- Le bois est un produit naturel, ce qui fait que les réclamations reposant sur des phénomènes naturels ne tombent pas sous le coup de la garantie.
- Les réclamations concernant les matériaux ne sont pas acceptées si une peinture a déjà été appliquée!
- Nœuds qui sont inhérents au bois.
- Décolorations du bois qui n'exercent pas d'influences sur la durée de vie.
- Fissures / fentes de retrait qui ne sont pas traversantes et qui n'exercent pas d'influences sur la construction.
- Déformations du bois, sous réserve qu'il puisse encore être mis en œuvre.
- Sur les faces non visibles des planches du toit et du plancher, il se peut que les planches ne soient pas rabotées, on peut observer des différences de couleur et des flaches.
- Une réclamation tardive résultant d'un montage incorrectement réalisé, d'un affaissement de la maisonnette par suite de fondations et de soubassements incorrectement réalisés, est exclue.
- Une réclamation suite à des modifications apportées de son propre chef à la maisonnette, comme par exemple une déformation des madriers et des fenêtres/portes par suite d'une peinture du bois ou d'une construction insuffisantes, la fixation trop rigide du contreventement, le vissage des dormants sur les madriers, etc., est exclue.

Les recours en garantie se limitent au remplacement du matériel défectueux. Tous les autres recours sont exclus!



Peinture et entretien

Le bois est un produit naturel qui travaille de façon variable. Des caractéristiques telles que les madrures grossières et fines, les nuances de couleurs et les modifications, de même que les imbrications, ont leur origine dans la croissance du bois. Dans le cas de bois qui poussent en pleine nature, ces caractéristiques sont normales et ne doivent par conséquent pas être considérées comme des défauts mais, au contraire, comme une particularité de ce matériau naturel qu'est le bois.

Au bout de quelque temps, le bois non traité (à l'exception des longrines) prendra une teinte grise, il pourra bleuir et moisir. Pour protéger votre maisonnette en poutres, il convient que vous le traitiez avec des produits de protection du bois appropriés.

Pour protéger votre maison de jardin de façon optimale, nous vous conseillons de traiter préalablement les planches du plancher à l'aide d'un apprêt incolore. En particulier la face inférieure à laquelle vous ne pourrez plus avoir accès après le montage. Ce n'est que de cette façon que l'on empêche l'humidité de pénétrer.

Nous conseillons de traiter impérativement les portes et les fenêtres également à l'aide d'un apprêt. Il est très important de peindre en une seule fois aussi bien les faces intérieures que les faces extérieures des portes et des fenêtres! Dans le cas contraire, elles pourront se déformer.

Une fois le montage effectué, nous vous conseillons de revêtir l'extérieur (sans le toit) d'un apprêt. Dès que cet apprêt sera sec, vous devrez revêtir votre maison d'un glacis pour bois qui protégera le bois contre l'humidité et le rayonnement ultraviolet.

Pour la peinture, n'utilisez qu'un outillage et une peinture de haute qualité, et respectez les consignes de sécurité et de mise en œuvre du fabricant de peintures. Ne peignez jamais en plein soleil ou lorsque le temps est à la pluie. Faites-vous conseiller de façon détaillée par votre revendeur spécialisé quant à la protection à utiliser pour les conifères non traités.

En refaisant régulièrement la peinture, vous augmentez sensiblement la durée de vie de votre maison de jardin. Nous vous conseillons également une inspection semestrielle de votre maison de jardin.

2 Préparation au montage

Outils et préparation des détails

Pour le montage, vous avez besoin du matériel suivant:



une personne pour vous aider au montage



échelle double



marteau



niveau à bulle d'air



tournevis



scie



couteau



mètre-ruban



pince



foret

REMARQUE: Pour éviter les blessures provoquées par d'éventuels éclats de bois, nous vous demandons de porter des gants de protection correspondants lors du montage.



Nous vous souhaitons beaucoup de moments heureux, une installation réussie et beaucoup d'années joyeuses dans votre maisonnette!

1 Generalidades



Estimado cliente,

¡Nos alegra que haya elegido una casita nuestra!

¡Por favor, lea atentamente el manual de montaje antes de empezar a armarla! Esto le evitará problemas y pérdida de tiempo.

Recomendaciones:

- Hasta que empiece a armar la casa mantenga el paquete en su embalaje y en un lugar seco evitando el contacto directo con el suelo, protéjalo de la intemperie (humedad, sol, etc.) ¡No deje el paquete en lugares calientes!
- Al seleccionar la ubicación de la cabaña en su jardín, evite lugares donde quede expuesta a efectos fuertes de la intemperie (nevadas o vientos fuertes), en caso contrario será necesario fijar la casa al suelo (por ejemplo, con anclajes).



Garantía

Su casita está hecha de abeto de alta calidad y se entrega al natural (sin pulir). Si, a pesar de nuestras minuciosas inspecciones, descubriese defectos, presente llene la ficha de control y preséntela al vendedor junto con la factura.

ATENCIÓN: ¡Por favor, conserve la documentación adjunta al paquete! La ficha de control incluye el número de serie de la casita. ¡Sus quejas serán atendidas solamente si suministra al vendedor el número de control de su casita!

La garantía no cubre:

- Peculiaridades naturales de la madera
- Piezas que hayan sido pintadas (tratadas con preservantes)
- Piezas con nudos que no afectan la estabilidad de la casita
- Piezas con diferentes tonos de color debidos a la estructura de la madera y que no afectan su vida útil
- Piezas con pequeñas grietas/fisuras (causadas por el secado) que no atraviesan la pieza y no afectan la estructura de la casita
- Piezas de madera torcidas que pueden ser usadas en la casa
- Tablas del techo o suelo que, en su superficie oculta, puedan tener zonas sin pulir, variaciones de color o desgastes
- Problemas provocados por el montaje incompetente de la casita o hundimiento de la casita debido a cimentación deficiente
- Problemas causados por alteraciones arbitrarias en la casa, como deformación de las piezas de madera o de las ventanas o puertas como consecuencia del tratamiento incompetente de la madera; ajuste excesivo de los ganchos de tormenta, atornillado de los marcos de las puertas a los troncos de las paredes, etc.

Las reclamaciones por problemas cubiertos por la garantía se limitan a reemplazar los materiales deficientes / defectuosos. ¡No se aceptan otras reclamaciones!



Pintado y mantenimiento de la casa

La madera es un material natural que crece y se adapta a las condiciones climáticas. Grietas pequeñas o grandes, diferencias y cambios en los matices de colores y sus alternancias estructurales no son fallas, sino resultados del crecimiento y de las características de la madera como material natural.

Con el tiempo la madera sin procesar (excepto las vigas de cimentación) y sin usar se vuelve gris o azul y criar moho. Proteja su casa tratándola de inmediato con un preservante de maderas.

Antes de armar la casa se recomienda tratar las tablas del suelo con un agente impregnante incoloro de madera, especialmente su lado oculto, al que no tendrá acceso después de armarla. Sólo así puede proteger las tablas contra la humedad.

¡También recomendamos tratar las puertas y ventanas con un agente impregnante tanto por dentro como por fuera! De lo contrario las puertas y ventanas se pueden deformar.

Después de armar la casa recomendamos, para su acabado final, usar pintura protectora para exteriores para evitar daños por humedad y radiación UV.

Al pintar su casa utilice únicamente herramientas y pinturas de alta calidad, siga los manuales de pintura y las instrucciones de seguridad y uso del fabricante. No se debe pintar bajo luz solar intensa o bajo la lluvia. Consulte un especialista sobre pinturas para madera suave no procesada y siga las instrucciones del fabricante de la pintura.

Pintando la casa apropiadamente prolongará considerablemente su vida útil. Se recomienda revisar cuidadosamente de la cabaña cada seis meses.

2 Preparativos para el ensamblado

Herramientas y la preparación de los componentes

Para montar la casa se necesita lo siguiente:



Ayudante



Escalera



Martillo



Nivel



Destornillador



Sierra



Cuchillo



Metro



Alicate



Taladro

Consejo: Para protegerse de las astillas se recomienda usar guantes protectores durante el trabajo.



¡Le deseamos éxito en el montaje de su casa y que la disfrute por muchos años!

1 In generale



Gentile Cliente,

siamo veramente lieti che Lei abbia scelto la nostra casetta di legno per il Suo giardino!

E' importante leggere accuratamente le istruzioni prima di iniziare con il montaggio della Sua casetta di legno! In tal modo eviterà qualsiasi problema e perdita di tempo.

Consigli:

- Conservare il kit in luogo asciutto e non direttamente sul pavimento, protetto da agenti atmosferici (acqua, sole ecc.) fino al montaggio definitivo. Non conservare il prodotto in ambienti riscaldati !
- Nella scelta del luogo di collocamento, fare attenzione che la casetta non sia esposta a condizioni atmosferiche estreme (vento forte); eventualmente ancorare la casetta ulteriormente con le fondamenta.



Garanzia

La vostra casetta è stata realizzata con pregiato legno di abete rosso nordico e viene consegnata in stato non trattato. Qualora, nonostante il nostro accurato controllo in fabbrica, dovessero sorgere reclami, sarà necessario presentare al negoziante il certificato di controllo compilato insieme alla fattura d'acquisto!

IMPORTANTE: E' assolutamente necessario conservare la documentazione! Sul certificato di controllo è riportato il numero di controllo della casa. Reclami possono essere evasi in garanzia unicamente se comunicherete il numero di controllo al vostro negoziante!

Divergenze che escludono motivo di reclamo:

- Il legno è un prodotto naturale e pertanto le contestazioni relative allo stato naturale non rientrano nella garanzia.
- Reclami relativi al materiale non vengono accettati una volta verniciato!
- Rami cresciuti nel legno.
- Scolorimenti del legno che non influiscono sulla durata.
- Crepe /fessure non passanti che non compromettono la costruzione.
- Nodi nel legno a condizioni che possa ancora essere lavorato.
- Nei punti invisibili del tavolame tetto e pavimento sono ammesse tavole non piallate; sono inoltre ammesse differenze di colore e spigoli dell'albero.
- Reclami successivi dovuti a montaggio non conforme, cedimento della casetta a causa di fondamenta errate sono esclusi.
- I reclami causati introducendo modifiche proprie alla casetta, p.es. deformazione di tavole e finestre/porte dovute ad un montaggio incompetente, fissaggio troppo rigido del listello antivento, avvitarmento dei telai delle porte con le tavole di legno ecc., sono esclusi.

Le rivendicazioni di garanzia sono limitate alla sostituzione del materiale difettoso. Ogni altra rivendicazione è esclusa!



Verniciatura e cura

Il legno è un prodotto naturale e si muove in modo diverso. Caratteristiche quali venature grosse e fini, sfumature di colore e cambiamenti nonché nodi sono dovuti alla crescita dell'albero. Sono del tutto normali nei legni che crescono all'aperto, e pertanto non sono da considerare difetti ma piuttosto una caratteristica del legno naturale.

Il legno non trattato (ad eccezione dei travetti) diventa grigio col tempo, può scolorirsi e fare la muffa. Per proteggere la vostra casetta di legno, è consigliabile trattarla con opportuni preservanti per legno.

Per proteggere al meglio la vostra casetta da giardino, consigliamo di trattare le tavole del pavimento preventivamente con un colore di fondo neutro, in particolare la parte inferiore che non sarà più raggiungibile dopo il montaggio. Solo in questo modo la penetrazione di umidità potrà essere evitata.

Consigliamo di trattare in ogni caso anche porte e finestre con un colore di fondo. E' molto importante verniciare sia il lato interno che quello esterno delle porte in un'unica soluzione, altrimenti potrebbero deformarsi !

Dopo il montaggio, consigliamo di applicare uno strato di fondo sulla pelle esterna (senza tetto), non appena il medesimo si sarà asciugato, verniciare la casetta con una velatura per legno per proteggere il legno dall'umidità e dalle radiazioni UV.

Per la verniciatura, usare attrezzi e vernici di qualità e rispettare le istruzioni di sicurezza e applicazione del produttore della vernice. Non verniciare in pieno sole o in caso di pioggia. Farsi consigliare dettagliatamente dal venditore sulla protezione di legni di conifera non trattati.

Con una regolare verniciatura aumenterete notevolmente la durata della vostra casetta da giardino. Consigliamo un'ispezione semestrale della casetta.

2 Preparazione al montaggio

Attrezzi e preparazione dei particolari

Attrezzi occorrenti:



aiutante



scala doppia



martello



livella a bolla d'aria



cacciavite



sega



coltello



metro



pinza



trapano

AVVERTENZA: Per evitare lesioni causate da eventuali schegge di legno, portare guanti di protezione durante il montaggio.



Vi auguriamo successo nel montaggio della casa e speriamo che la godrete per molti anni!

1 Generell informasjon



Kjære kunde,

det gleder oss at du valgte hagehuset vårt!

Les monteringsanvisningen grundig før du går i gang med å sette sammen huset! For å unngå problemer og bruk av unødig tid.

Husk:

- La huset være innpakket og oppbevar det på et tørt sted, ikke i direkte kontakt med bakken og godt beskyttet mot vær og vind (fuktighet, solskinn osv.), helt frem til arbeidet påbegynnes. Huspakken må ikke oppbevares i et oppvarmet rom!
- Kontrollerer leveransen mot delelisten for å se om alle delene er inkludert, før du starter monteringen. Sorter delene i samsvar med monteringsanvisningen og legg de fire sidene ut i forhold til monteringsrekkefølgen.



Garanti

Dette huset er fremstilt av høykvalitets gran (furu brukes i enkelte tilfeller) og leveres ubehandlet. Dette huset har gjennomgått en grundig inspeksjon. Dersom du likevel skulle ha grunn til reklamasjon, ber vi deg fylle ut kontrollskjema og sende det sammen med kjøpsbeviset og kvitteringen til forhandleren.

OBS: Sørg for å oppbevare all dokumentasjon som følger med huspakken! Husets serienummer er oppført på kontrollskjema. Vi kan kun behandle en reklamasjon dersom du sender husets serienummer til forhandleren!

Garantien dekker ikke:

- Særegenhet i treverket som et naturlig materiale
- Deler som allerede er behandlet (malt, grunnet)
- Deler av huset som inneholder hele kvister som ikke representerer en fare for husets stabilitet
- Variasjoner i fargetone som er forårsaket av forskjeller i trestrukturen og som ikke har betydning for treverkets levetid
- Deler av huset som sprekker på grunn av tørking, dvs. små sprekker/ riss som ikke er gjennomgående og som ikke påvirker husets struktur
- Deler av vridt tre som likevel kan monteres
- Tak- eller gulvplank som på skjulte overflater kan oppvise uhøvlede områder, fargeforskjeller og vankant
- Reklamasjoner fordi huset er blitt montert på ukyndig måte eller fordi huset sigrer på grunn av ukyndig utført fundament
- Reklamasjoner fordi det er blitt gjort endringer på huset på eget initiativ, som f.eks. formendringer på deler av tre eller dører/ vinduer. På grunn av ukyndig behandling av treverket; at stormavstivere er festet for stramt, dørkarmen er blitt skrudd inn i veggbord eller lignende.

Reklamasjonene som dekkes av garantien er begrenset til å omfatte erstatning av manglende/ feil materiale. Alle andre krav er utelukket!

Produsent forbeholder seg retten til å endre tekniske egenskaper ved produktet.



Maling og vedlikehold av hagehuset

Tre er et naturlig materiale som beveger og tilpasser seg i forhold til værforholdene. Større eller mindre sprekker, fargeforskjeller og endringer samt ulikheter i treets struktur er ikke feil, men et resultat av treets vekst og en særegenhet i treverket som et naturlig materiale.

Ubehandlet treverk blir grått hvis det blir værende ubehandlet over tid og kan bli blått og begynne å råtne. For å beskytte treverket i hagehuset, må det før montering behandles med grunning.

Alle deler må behandles med grunning (f. eks. Visir) på alle sider (innvendig og utvendig), laftespor, not og fjær, før montering. Husk: Endeved 3-4 strøk vått i vått. Grunn vinduer og dører på alle sider. Grunn tak/gulvbord på alle sider.

Hvorfor grunning?

Det er ekstra mye endeved i en laftehytte. Hvert eneste laftespor har endeved. Det er endeveden som tar til seg mest fuktighet i treverk. Ved produksjon av en laftehytte blir treverket tørket før det blir produsert. Dette gjør at delene lettere tar til seg fuktighet når pakken blir åpnet. Tørket trevirke som blir utsatt for fuktighetssvingninger vil ofte vri seg og skape spenninger i treverket som kan utløse mange problemer. En grunning sin viktigste funksjon er å redusere fuktoptak og dermed redusere spenningsproblemer. Den andre viktige funksjonen til en grunning er å hindre dannelse av sopp og råte. Dette oppstår gjerne på steder som har dårlig lufting, som f. eks. i laftesporene. Når huset er ferdig montert, må det ferdige huset behandles med et værbestandig malingsstrøk utvendig som beskytter treverket mot fuktighet og UV-stråler. Innvendig må huset etterbehandles i henhold til bruksmønster.

Bruk maleredskaper og maling/ beis av høy kvalitet når du maler huset. Følg anvisningene på spannet og produsentens sikkerhets- og bruksanvisninger. Du må aldri male en overflate i sterkt sollys eller i regnvær. Forhør deg hos en malerspesialist når det gjelder hvilken maling som egner seg for ubehandlet myktré, og følg anvisningene fra produsenten.

Dersom huset er blitt malt på riktig måte, vil husets levetid forlenges betraktelig. Vi anbefaler at du inspiserer huset grundig hvert halvår.

2 Foreberedelse før montering

Verktøy og forberedelse før montering

Du trenger følgende verktøy ved montering:



monteringshjelp



stige



hammer



drill



vater



skrutrekker



sag



kniv



målebånd



avbiter tang

OBS: For å unngå flis anbefaler vi bruk av hansker under monteringen.



Vi ønsker deg lykke til med det nye hagehuset og håper du får glede av det i mange år!

1 Allmän information



Bäste kund,

Vi är glada för att du valt att skaffa ett trädgårdshus från oss!

Vänligen läs monteringsanvisningarna noggrant innan du påbörjar monteringen av huset! Du undviker därigenom problem och spillar ingen tid.

Rekommendationer:

- Förvara husets förpackning, tills det är färdigmonterat, på en torr plats, men inte i direkt kontakt med marken, skyddad från väder och vind (fukt, solljus, etc.). Förvara inte husets förpackning i ett uppvärmt utrymme!
- När du väljer plats för trädgårdshuset, försäkra dig om att huset inte utsätts för extrema väderförhållanden (områden med kraftigt snöfall eller vindar); i så fall bör du förankra huset (till exempel med jordankare) i marken.



Garanti

Ditt hus är tillverkat av gran av hög kvalitet och levereras i naturlig (obehandlad) form. Om du, trots vår noggranna besiktning, skulle ha några reklamationer, vänligen skicka den ifyllda kontrollblanketten och inköpsbeviset till vår återförsäljare.

SE UPP! Vänligen se till att behålla dokumentationen tillsammans med husets förpackning! Kontrollblanketten innehåller husets kontrollnummer. Vi kan enbart granska reklamationer om du skickar med husets kontrollnummer till återförsäljaren!

Garantin omfattar inte:

- Egenheter för trä som ett naturmaterial.
- Redan målade trädetaljer (behandlade med träskyddsmedel)
- Trädetaljer som innehåller hela kvistar som inte äventyrar husets stabilitet
- Variationer i färgton orsakade av olikheter i träets struktur som inte påverkar träets livslängd
- Trädetaljer som innehåller mindre sprickor/spalter (orsakade av torkning) som inte är genomgående och inte påverkar husets konstruktion
- Skeva trädetaljer som ändå går att montera
- Tak och golvbrädor som på sina dolda ytor kan ha vissa ohyvlade områden, färgskiftningar och - mattning
- Reklamationer på grund av oskicklig montering av huset eller sättningskador på grund av en felaktigt uppförd grund
- Reklamationer orsakade av egna ändringar av huset, så som deformation av trädetaljer och dörrar/fönster på grund av ett oskickligt tillvägagångssätt vid montering av trädetaljer; fastsättning av stormbeslag för styvt, dörrkarmar som skruvas i väggreglar, mm.

Reklamationer som omfattas av garantin tillgodoses i den omfattningen att det bristfälliga/felaktiga materialet ersätts. Alla andra anspråk lämnas utan åtgärd!



Målning och underhåll av trädgårdshus

Trä är ett naturmaterial som växer och anpassar sig efter väderförhållanden. Större och mindre sprickor, förändringar och skiftningar i färgton, samt även förändringar i träets struktur är inte felaktigheter, utan ett resultat av träets tillväxt och egenheter för trä som ett naturmaterial.

Obehandlat trä (undantaget grundsyllar) blir gråaktiga efter att ha lämnats orörda ett tag, de kan bli blå och börja mögla. För att skydda trädetaljer på ditt trädgårdshus måste du omedelbart behandla dem med träskyddsmedel.

Vi rekommenderar att du i förväg täcker golvbrädorna med ett färglöst träimpregneringsmedel, i synnerhet brädornas undersidor vilka du senare inte kommer åt när huset väl är monterat. Endast detta förebygger fuktinträning.

Vi rekommenderar definitivt att du även behandlar dörrar och fönster med ett bra impregneringsmedel och gör det både på in- och utsidan! Annars kan dörrar och fönster bli skeva.

Efter att huset är färdigmonterat, rekommenderar vi att slutbehandla det med en väderbeständig färg som skyddar träet från fukt och UV-strålning.

Använd redskap och färg av bra kvalitet vid målningen, följ användaranvisningen för färgen samt tillverkarens säkerhets- och användarinstruktioner. Måla aldrig en yta i starkt solljus eller vid regnväder. Rådgör med en specialist om färger som lämpar sig för obehandlat barrträ och följ färgtillverkarens anvisningar.

Husets livslängd förlängs avsevärt om det målas på rätt sätt. Vi rekommenderar att du besiktigar huset noggrant var sjätte månad.

2 Monteringsförberedelser

Verktyg och förberedelse av komponenter

För att montera trädgårdshuset behöver du följande verktyg:



monteringshjälp



stege



hammare



vattenpass



skruvmejsel



såg



kniv



måttband



tång



borr

RÅD: För att undvika att få stickor, rekommenderar vi att du använder arbetshandskar under monteringen.



Vi önskar dig lycka till med monteringen av trädgårdshuset och mycket glädje i många år framåt!