

Installation manual

Montageanleitung • Notice de montage • Istruzioni per il montaggio
Manual de montaje • Monteringsanvisning • Installatiegids • Asennusohje • Installationsmanual • Instrukcja instalacji • Paigaldusjuhend

Pavilion PAV-4236-1KI-1

Pavillon • Pavillon • Padiglione • Pabellón • Paviljonki • Paviljong • Pawilon • Paviljon

Width 417 x Depth 356 cm

Breite/Tiefe • Largeur/Profondeur • Lunghezza/Profondità • Ancho/Profundidad • Bredde/Dybde • Breedte/Diepte • Leveys/Pituus • Bredd/Längd • Szerokość/Głębokość • Laius/pikkus

Log thickness 18 mm

Bohlenstärke • Épaisseur des murs • Spessore delle pareti • Grosor de pared • Tykkelse • Wanddicke • Seinän paksuus • Väggtjocklek • Grubość ścian • Seinapaksus



The producer shall have the right to make technical changes to the product • Technische Änderungen vorbehalten • Le producteur réserve le droit d'effectuer des modifications techniques au produit • Il produttore mantiene il diritto di apportare modifiche tecniche al prodotto • Reservado el derecho a modificaciones técnicas • Producent forbeholder seg retten til å endre tekniske egenskaper ved produktet • Alle rechten en technische wijzigingen voorbehouden • Valmistaja pidättää oikeuden tehdä tuotteeseen teknisiä muutoksia • Tillverkaren har rätt att utföra tekniska förändringar för produkten • Producent zastrzega sobie prawo do dokonywania zmian technicznych produktu • Tootja jätab endale õiguse muuta toote tehnilisi omadusi

1 Generelt



Kære kunde,

Tak fordi du valgte vores havehus!

Venligst læs hele monteringsvejledning igennem før du går i gang for at undgå unødvendig tidsspilde og problemer!

Tips:

- Opbevar pakken med havehuset tørt, beskyttet mod vejr og vind og ikke direkte på jordoverfladen indtil monteringen er afsluttet. Pakken må ej heller være i nærheden af en varmekilde.
- Ved placeringen af havehuset vær opmærksom på, at huset ikke kommer til at stå i ekstreme vejrforhold (stærk vind, meget sne i.lign.), i så fald skal huset fæstnes med passende ankere til grunden.



Garanti

Havehuset er fremstillet af højkvalitativ gran tømmer og leveres i ubehandlet stand. Hvis der på trods af vores grundig kvalitetskontrol skulle være klager eller mangler ved huset, skal disse indgives til sælgeren sammen med udfyldt kontrolskema og indkøbskvittering.

OBS: Venligst opbevar vedlagte dokumentation til havehuset! Husets kontrolnummer fremgår af kontrolskemaet. Klager kan kun indgives hvis I oplyser kontrolnummeret til sælgeren.

Garantien omfatter ikke følgende:

- Ujævnheder og afvigelser grundet træets naturlige egenskaber
- Detaljer som allerede er behandlede med træbeskyttelse
- Detaljer som indeholder hele knaster der ikke påvirker husets stabilitet
- Afvigelser i træets farvenuancer som ikke påvirker træets levetid
- Detaljer som indeholder små sprækker opstået ved tørning der ikke er gennemgående og som ikke påvirker husets konstruktion
- Trædetaljer med skævhed, der stadig kan monteres
- Tag- og gulvbrædder, der indeholder uhøvlede pletter, farveafvigelser eller andre pletter i ikke synlige steder
- Klager der opstået pga. ukyndig montering af huset eller ved placeringen af huset på et ukorrekt udført fundament
- Klager, der er opstået pga. egne tiltag eller ændringer ved huset, såsom skævhed af trædetaljer, døre og vinduer pga. ukyndig behandling af træet; stormlisternes for stram montering; dørkarme fastmonteret i vægdetaljer o.lign.

Garantien udøves ved at ombytte den fejlbehæftede element med en ny. Alle andre krav tilgodeses ikke!



Havehusets maling og vedligeholdelse

Træ er et naturmateriale, der bevæger sig afhængigt af vejrforhold. Små og store sprækker, farveafvigelser og ændringer, samt ændret træstruktur er ikke fejl, men træets egenskaber som naturmateriale.

Ubehandlet træ (undtagen fundamentsprosser) ændres efterhånden til gråligt, kan endda blive blåligt og muggent. For at beskytte dit havehus og dens trædele bedst, skal du så hurtigt som muligt behandle træet med træbeskyttelse.

Vi anbefaler først at behandle gulvbrædder med et ufarvet træbeskyttelse, specielt bræddernes underside, som ikke vil være tilgængeligt for yderligere behandling efter monteringen. Kun på den måde kan man forhindre fungten at trænge ind.

Vi anbefaler, at du behandler også døre og vinduer med træbeskyttelse. Det er vigtigt at behandle døre og vinduer både på inder- og ydersiden! Ellers kan de trække sig skæve efterhånden.

Efter monteringen af huset anbefaler vi brugen af en passende maling for at beskytte ydersiden mod vejr, vind og UV-stråling.

Brug højkvalitative redskaber og maling under malingsarbejdet, følg instruktioner og anbefalinger fra malingsproducenten. Mal aldrig i direkte sollys eller i regnvejr. Søg tips og råd hos din malingsforhandler og følg deres instruktioner.

Regelmæssig maling af havehuset forlænger betydeligt dets levetid. Vi anbefaler en grundig gennemgang af huset ved hvert halve år.

2 Forberedelse for montage

Redskaber og forberedelse af alle elementer

For monteringen har du brug for følgende redskaber og værktøj:



en hjælper



stige



hammer

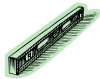

vatterpass



skruetrækker



sav



kniv



målebånd



tang



boremaskine











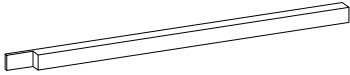
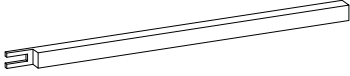
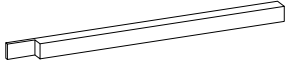

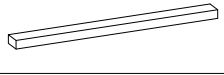
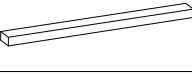
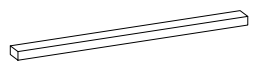

TIPS: For at undgå splinter anbefaler vi brug af arbejdshandsker.

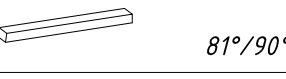

**Pøj-pøj med monteringen af Dit nye havehus!
Vi håber, I får glæde af det mange år frem i tiden!**











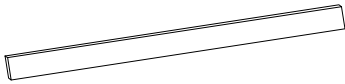

Nova 13,0 m2 - PAV-4236-1KI-1

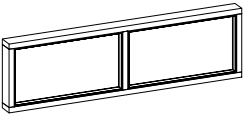
1/2

Pos nr	Detail	Dimensions (mm)	Info	Qty
1		120 x 120 x 2760		2
2		120 x 120 x 2760		1
3		120 x 120 x 2225		2
4		120 x 120 x 2000		2
5		90 x 225 x 4286		2
6		42 x 120 x 3315		2
7		34 x 70 x 1932		9
8		34 x 70 x 825		4
9		34 x 70 x 757		6
10		34 x 70 x 941		12
11		34 x 70 x 3934		2
12		34 x 70 x 3281		2
13		34 x 70 x 3327		2
14		34 x 70 x 519		2
15		34 x 70 x 327		2
16		34 x 70 x 146		2
17		34 x 70 x 71		2
18		18 X 135 X 2000		67
19		45 X 45 X 1967		2
20		45 x 70 x 3934		1

Nova 13,0 m2 - PAV-4236-1KI-1

2/2

Pos nr	Detail	Dimensions (mm)	Info	Qty
21		56 x 225 x 3445		3
22		56 x 225 x 3452		2
23		44 x 95 x 2100		2
24		28 x 95 x 4324		1
25		19 x 95 x 3816		2
26		56 x 120 x 175		5
27		545 x 120 x 1907	A120-2	2
28	Roofing set			1
29	Doors set			1
F1		Ø4.5 x 50	QKRPP4_5x50ZnTX	25
F2		Ø4.5 x 70	QKRPP4_5x70ZnTX	50
F3		Ø5 x 40	QKRYP5x40ZnTX	56
F4		Ø5 x 90	QKRPP5x90ZnTX	180
F5		Ø6 x 120	QKRPP6x120ZnTX	40
F6		Ø8 x 220	QKRPP8x220kZnTX	20
F7		Ø2.2 x 50	QNA2_2x50Zn	650

*F3 not needed (for optional door set)

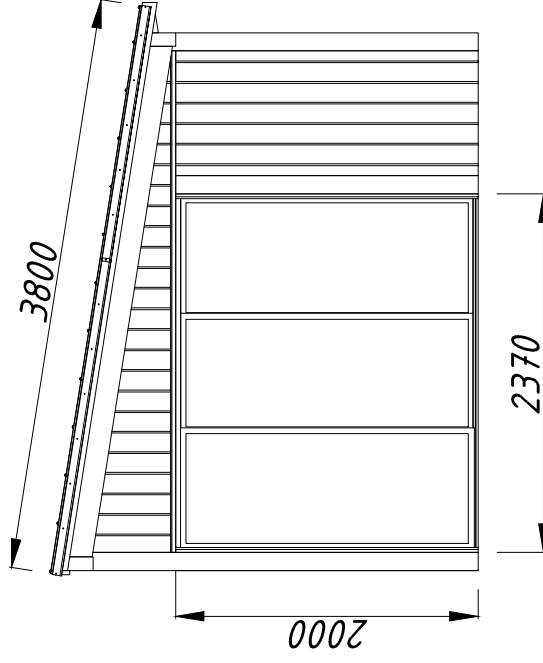
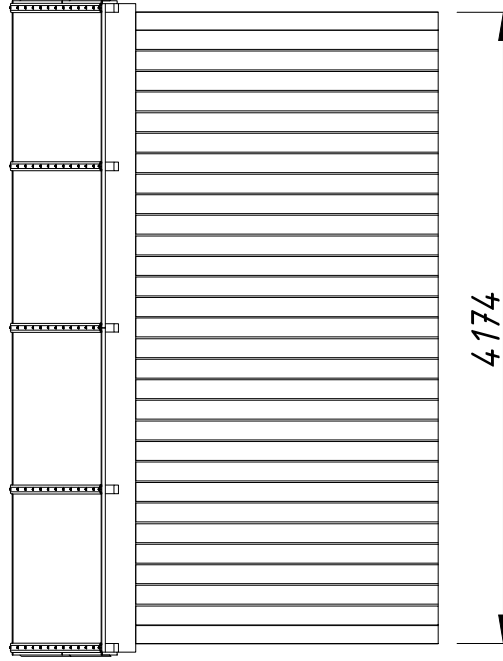
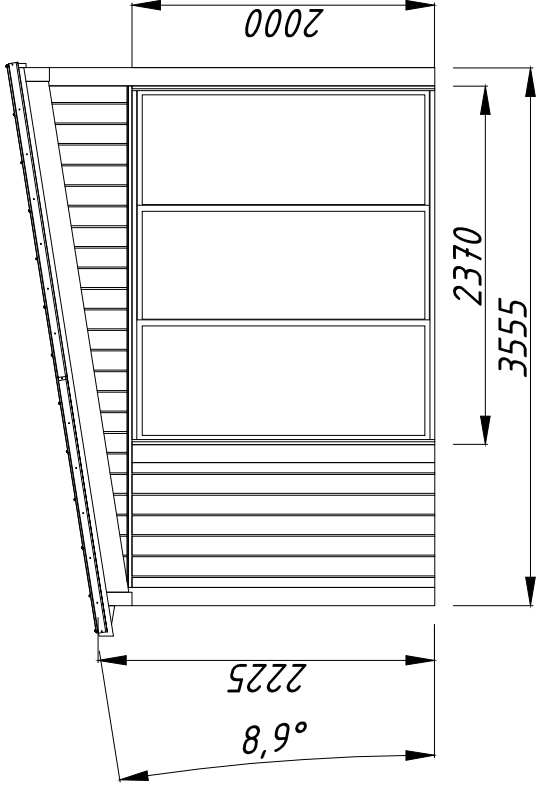
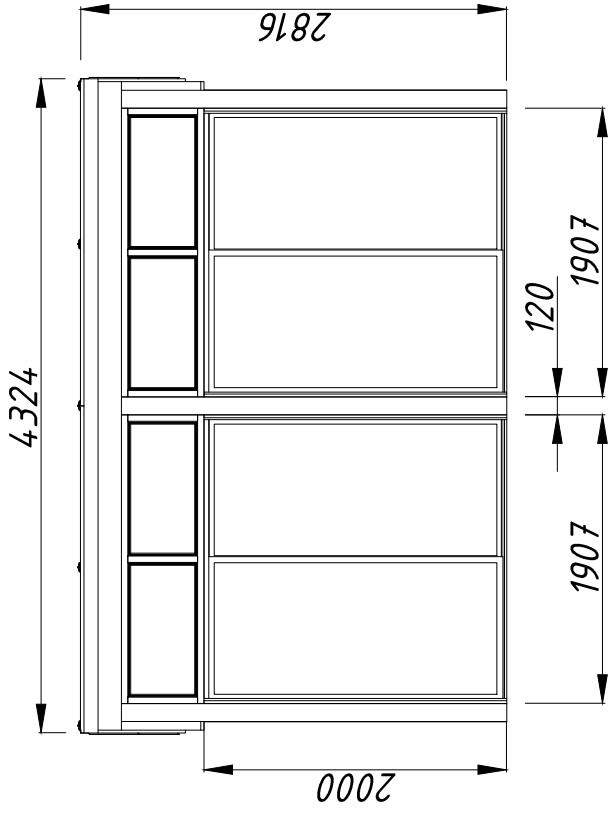

Object name
PAV-4236-1KI-1

Drawing
Elevations

Scale 1:50

Paper A4

Palmako
LEMEKS GROUP
AS Palmako
Näiture 25, Tartu 50409, Estonia
tel. +372 73 55 530
fax. +372 73 55 544
www.palmako.com

Customer Log

Drawn by 945

Date 14.05.2020

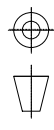

Page 1

File Drawing1.dwg

- Det 1 - 2 pcs
- Det 2 - 1 pcs
- Det 3 - 2 pcs
- Det 4 - 2 pcs

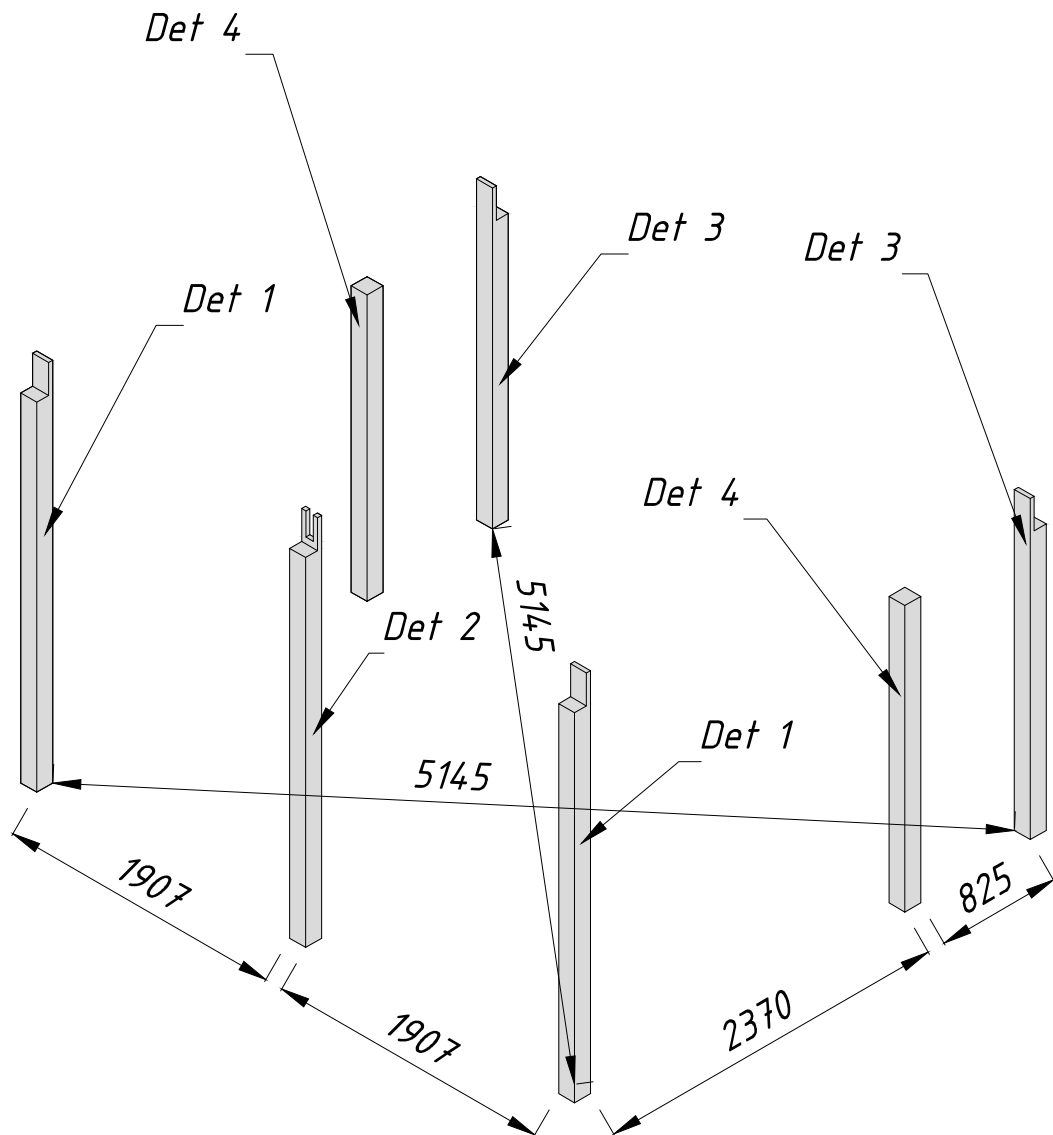

Det 6 - 2 pcs
F4 - 16 pcs

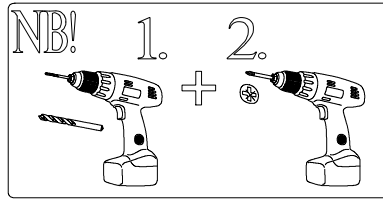

2

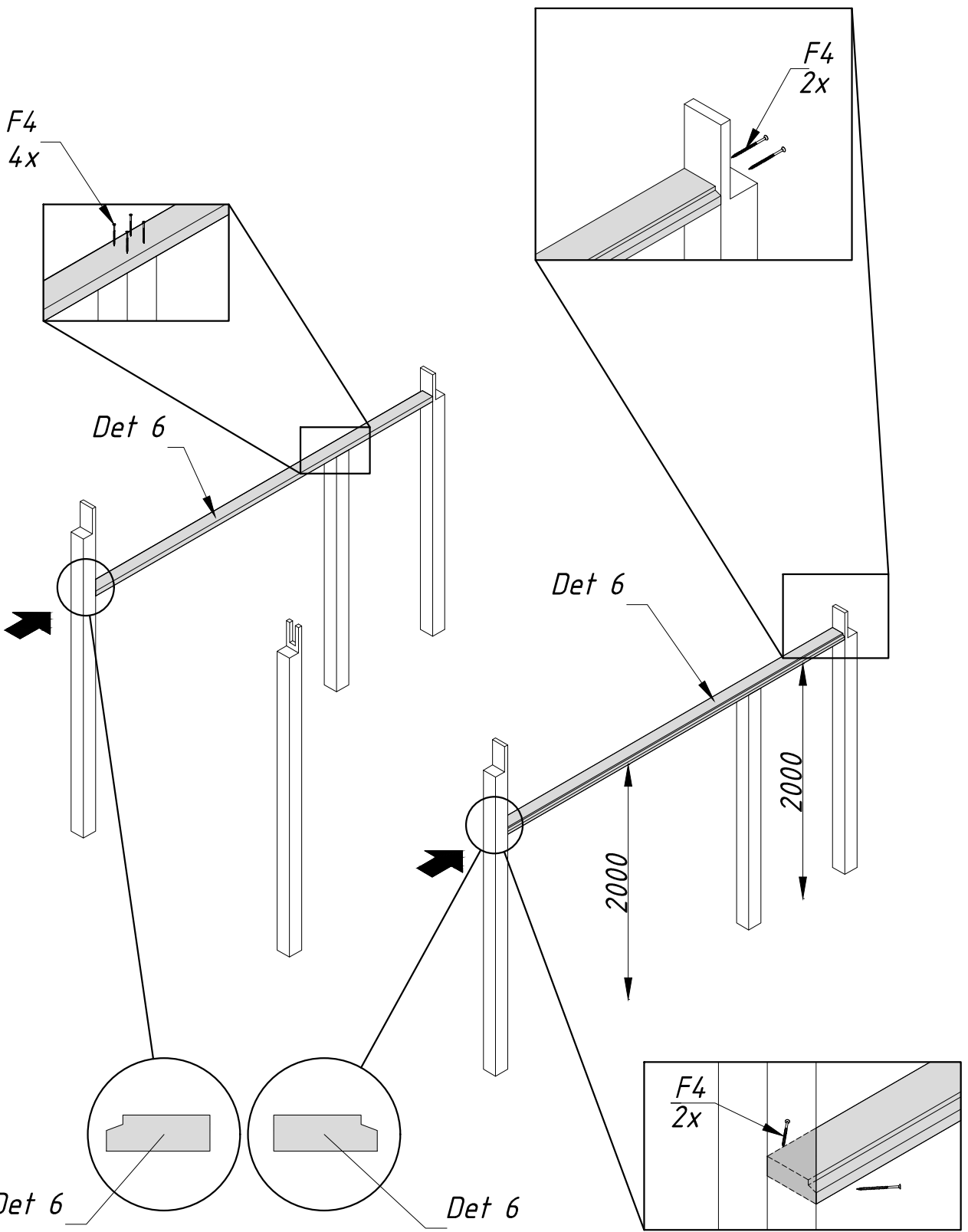

Det 5 - 2 pcs
F4 - 20 pcs

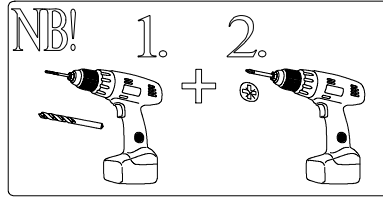

3

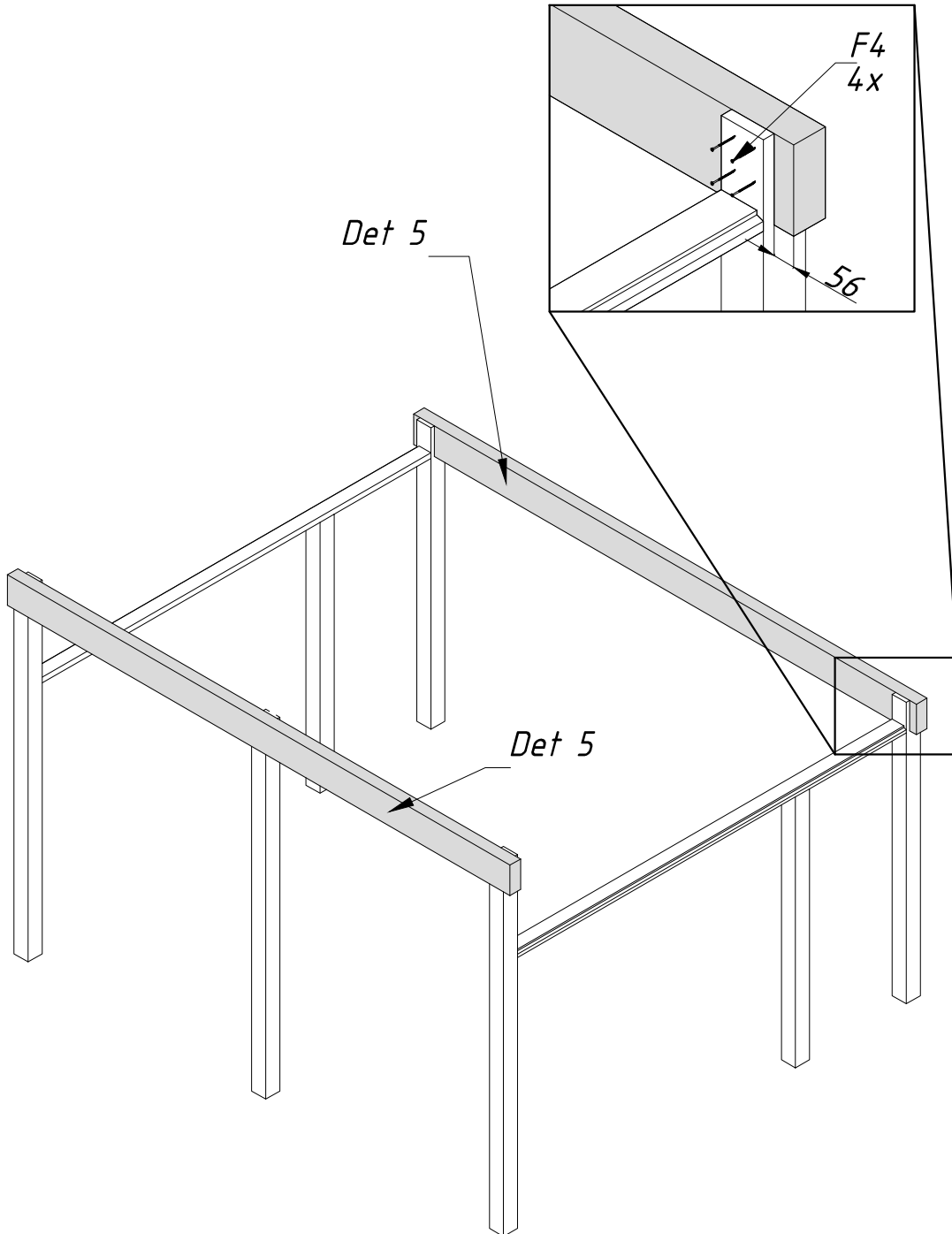

- Det 7 - 4 pcs
- Det 8 - 4 pcs
- Det 9 - 6 pcs
- F4 - 20 pcs

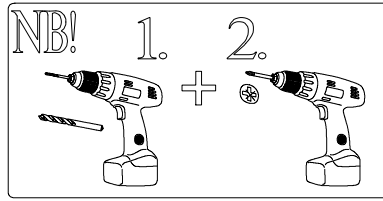

4

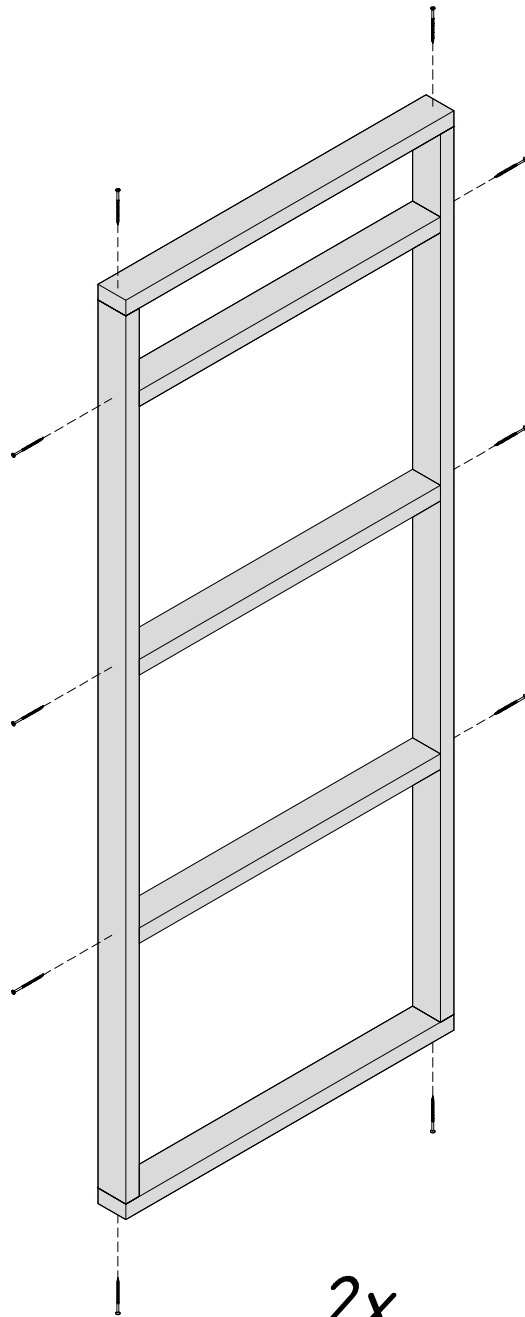

2x

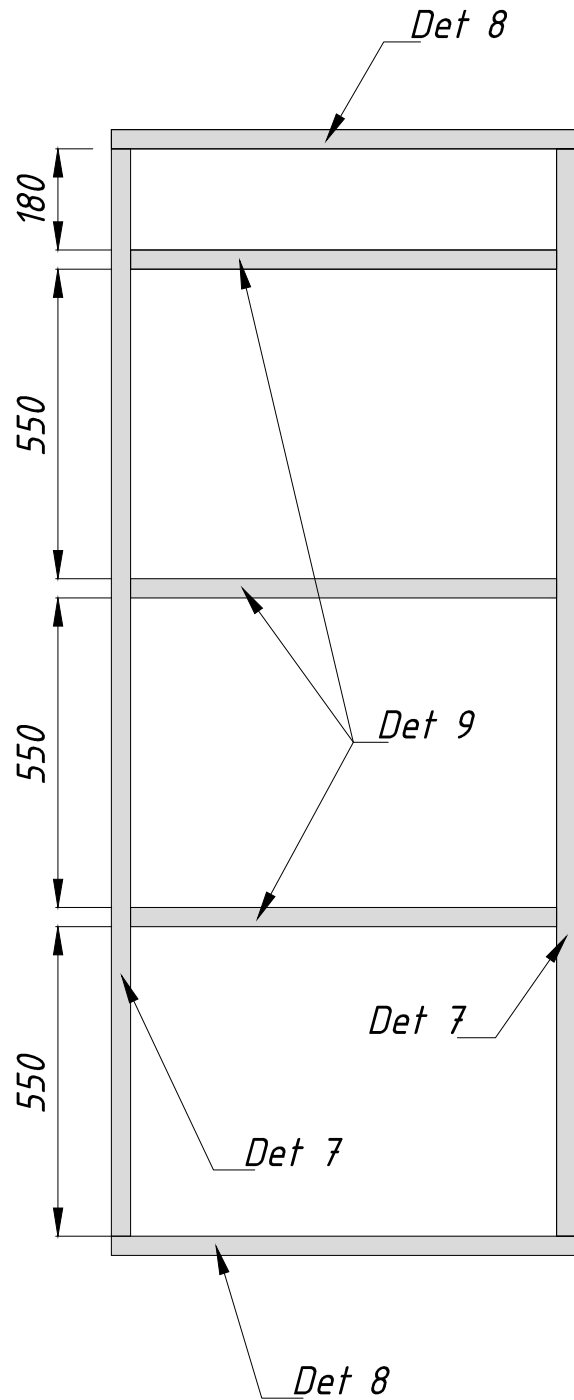

Det 18 - 14 pcs
F7 - 120 pcs

5

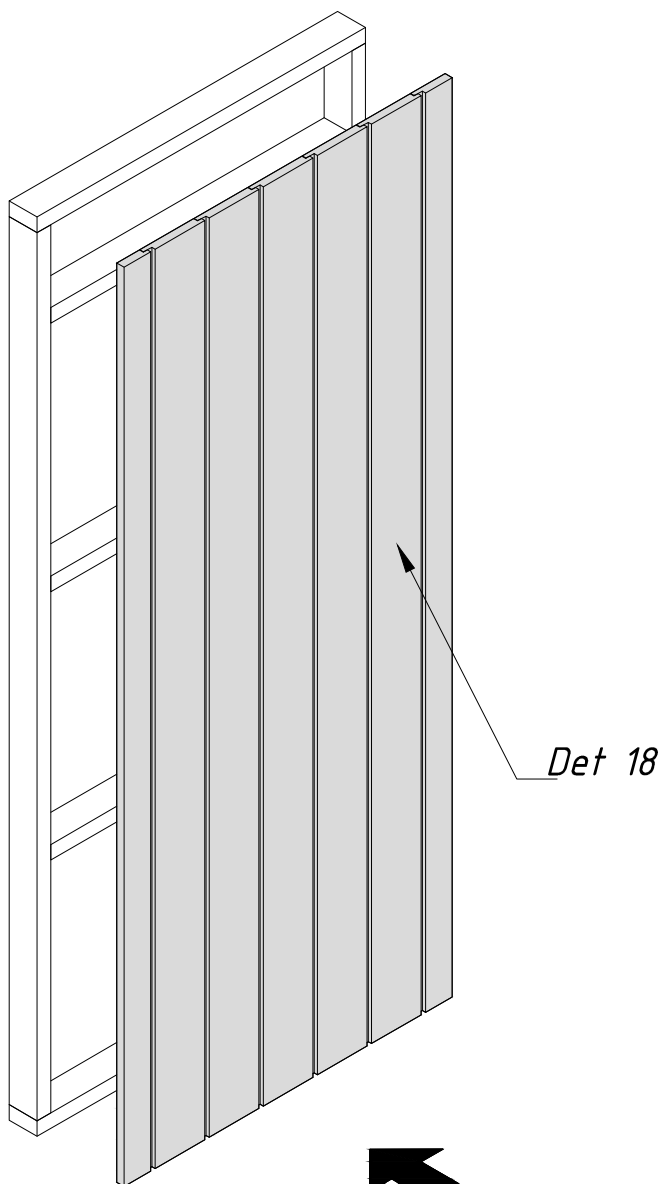

2x

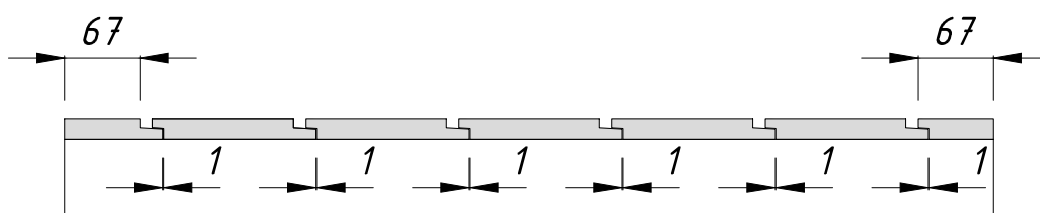

- Det 7 - 5 pcs
- Det 11 - 2 pcs
- Det 10 - 12 pcs
- F4 - 34 pcs

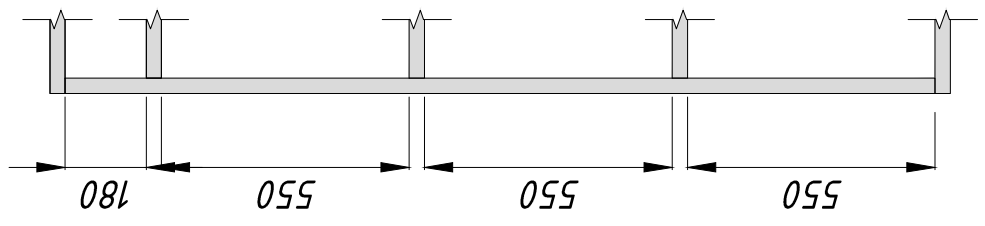
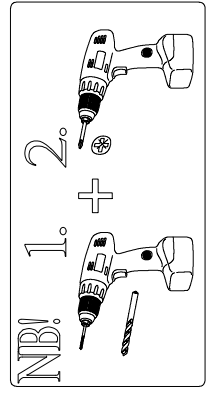

6

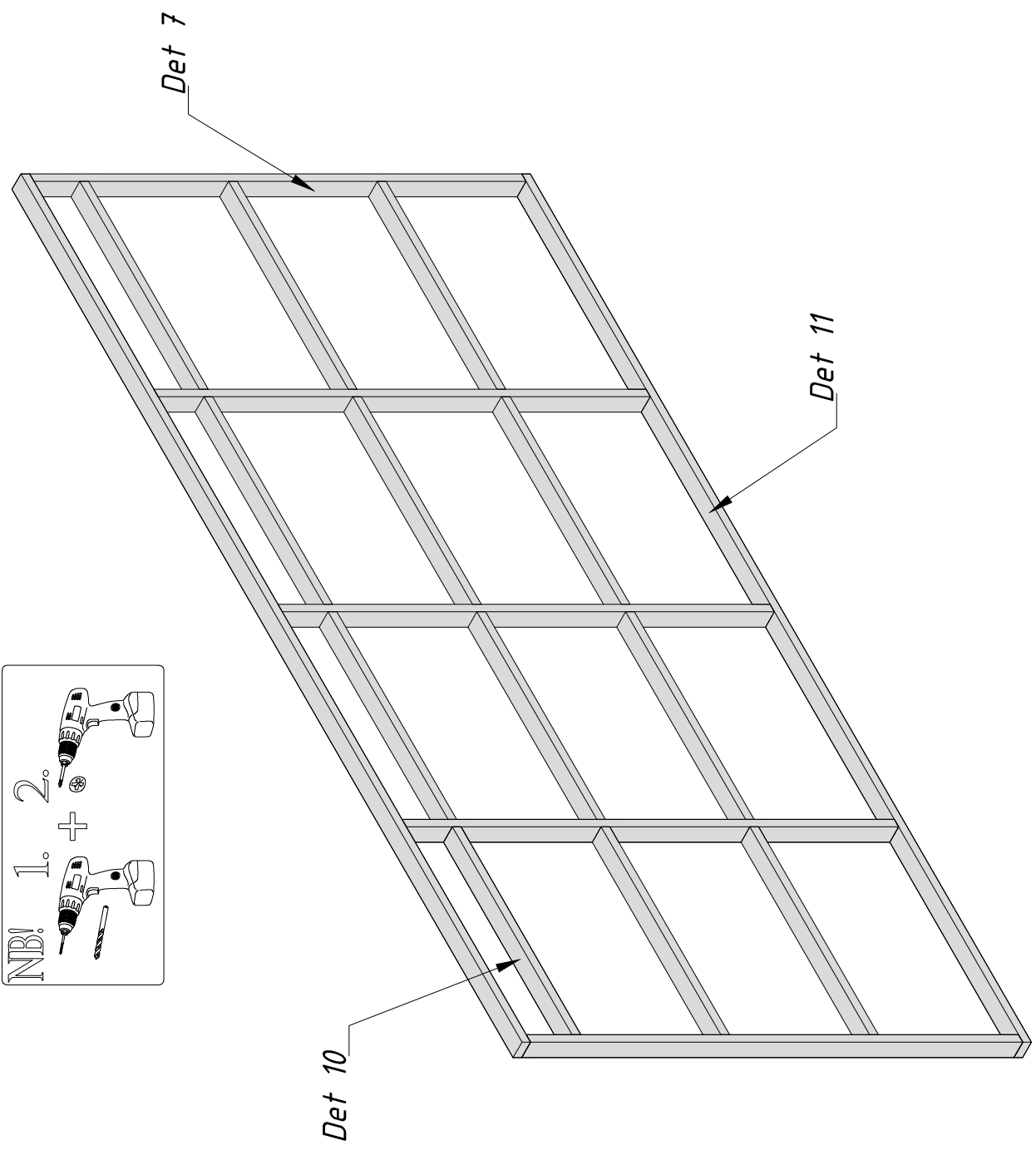

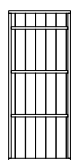

- 2 pcs

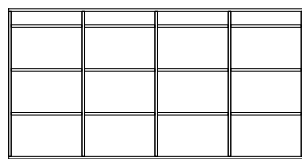

- 1 pcs

F4 - 28 pcs

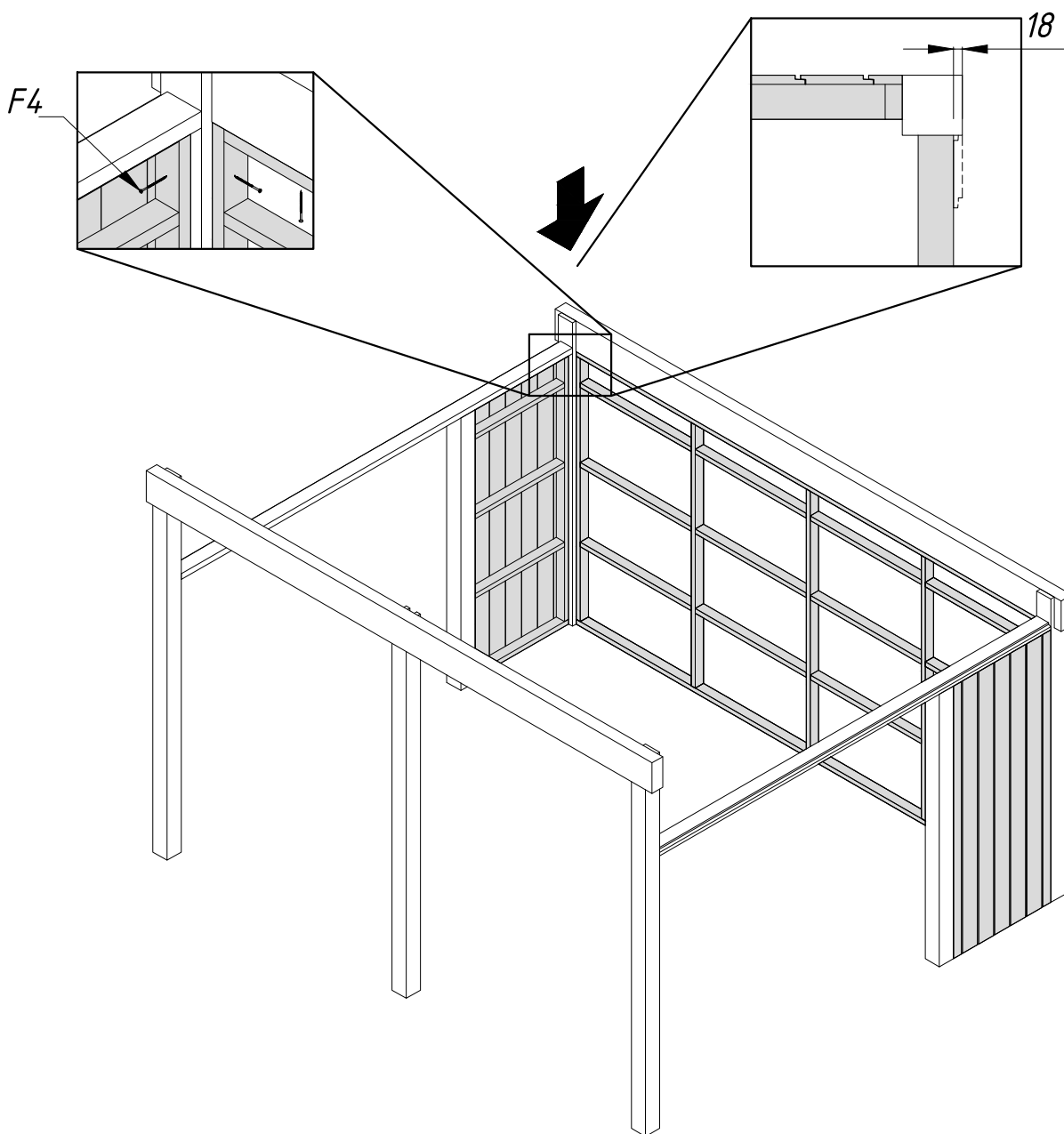
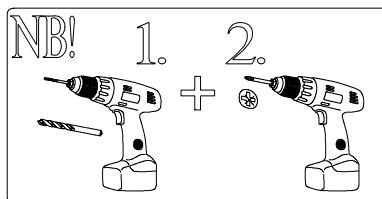

Det 18 - 29 pcs
F7 - 290 pcs

8

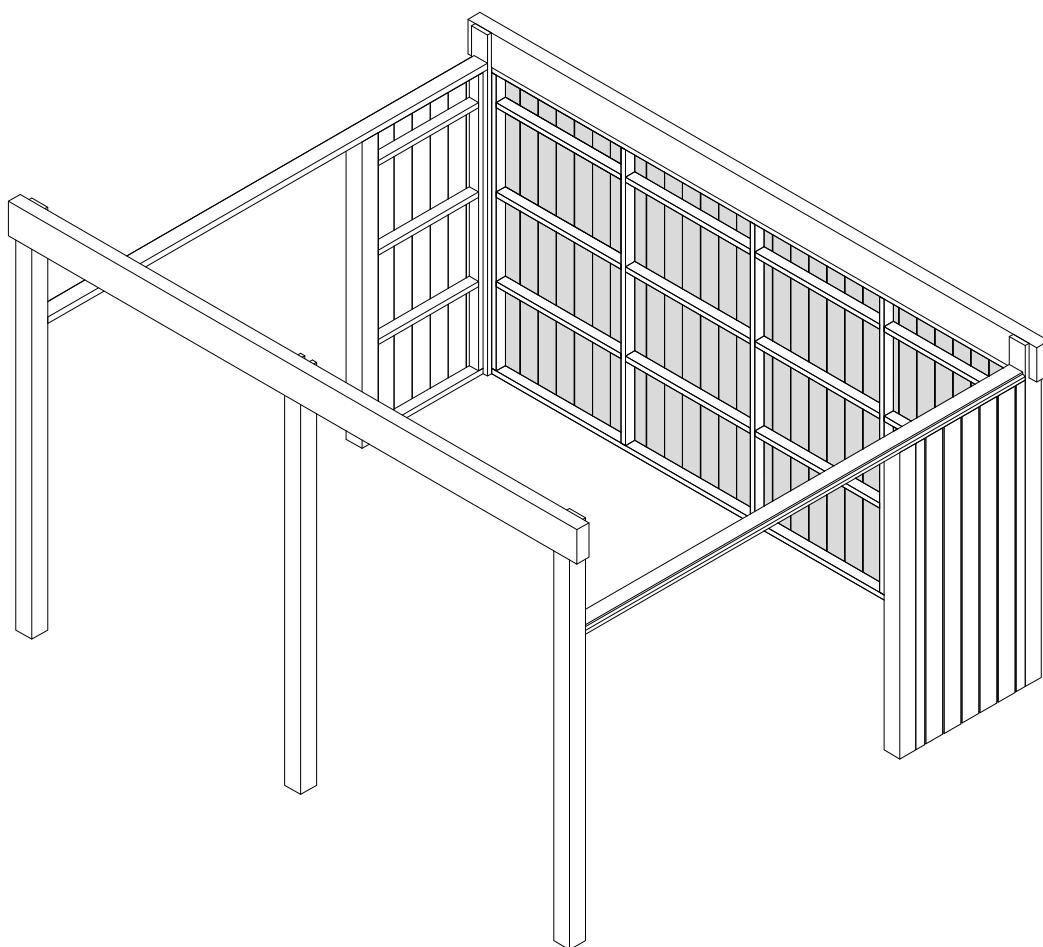
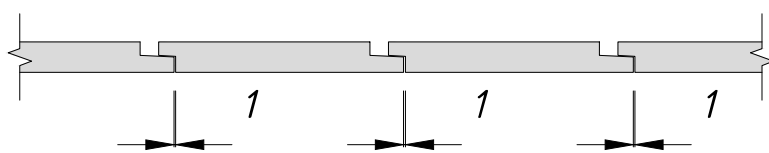

- Det 12 - 2 pcs
- Det 13 - 2 pcs
- Det 14 - 2 pcs
- Det 15 - 2 pcs
- Det 16 - 2 pcs
- Det 17 - 2 pcs
- F4 - 16 pcs

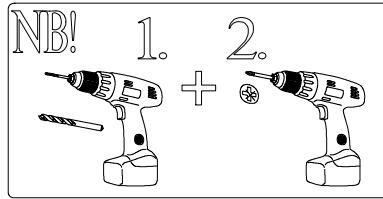

9

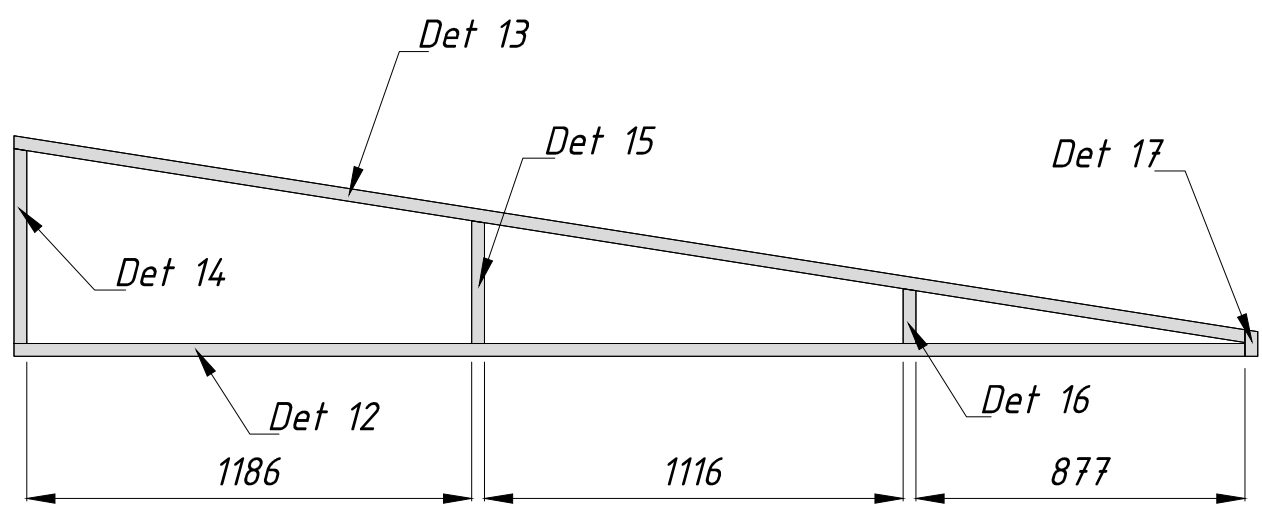
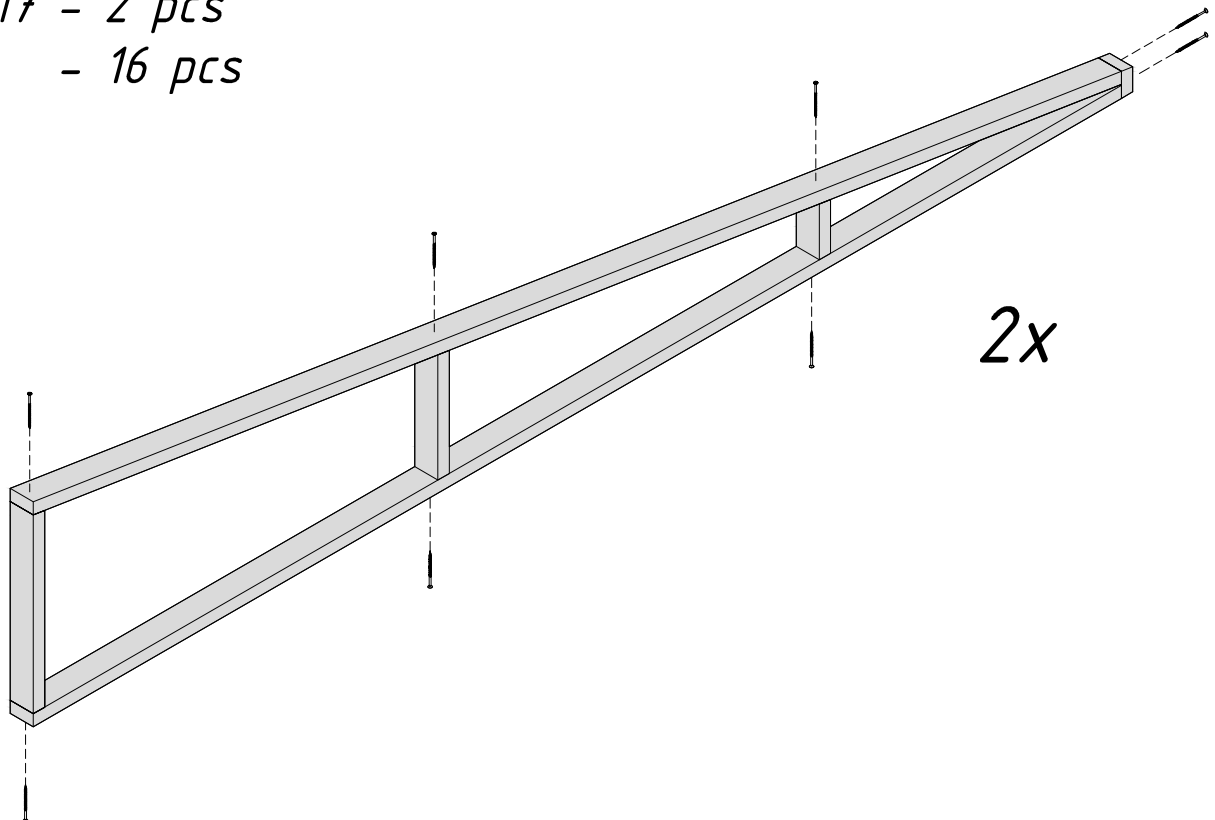

Det 18 - 24 pcs
F7 - 210 pcs

10

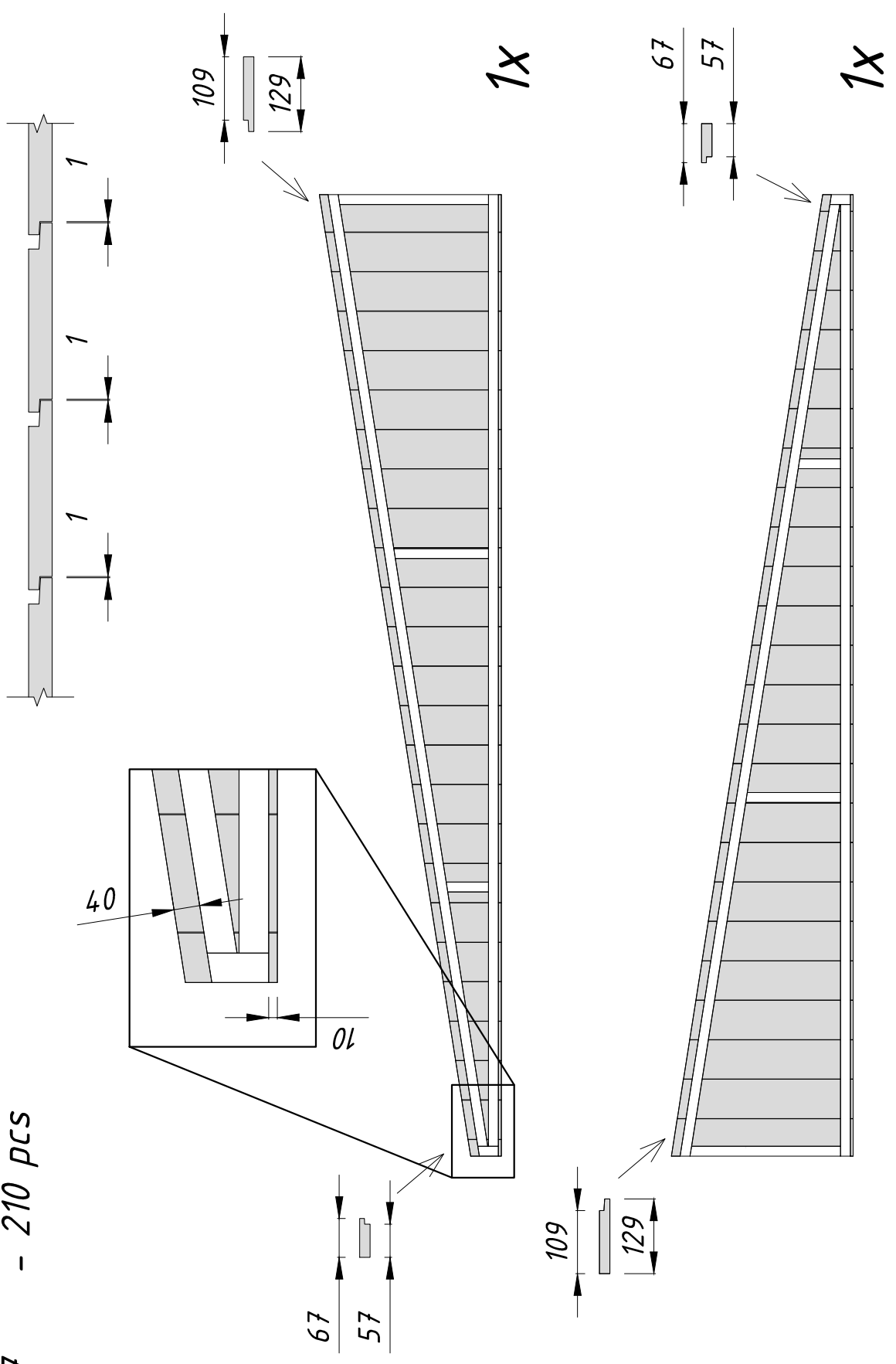

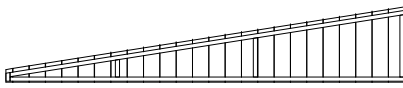
 - 1 pcs

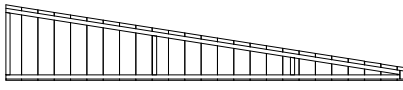
 - 1 pcs

F5 - 6 pcs

F2 - 12 pcs

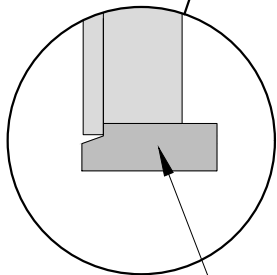
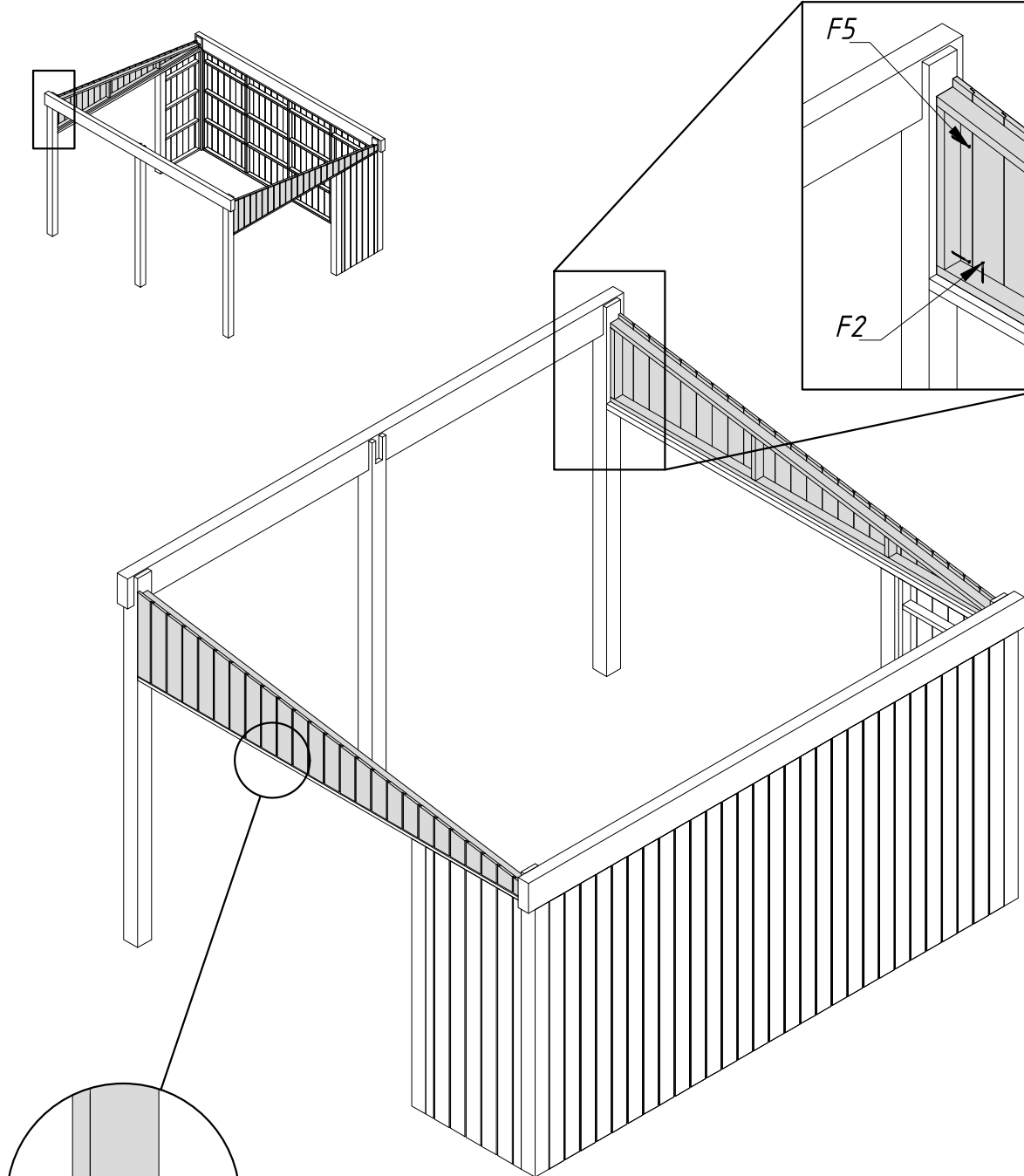
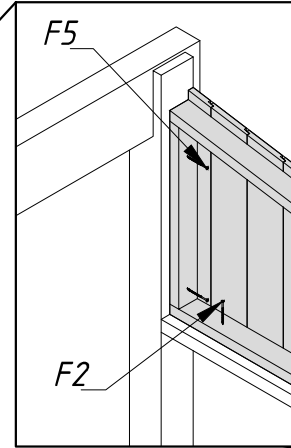
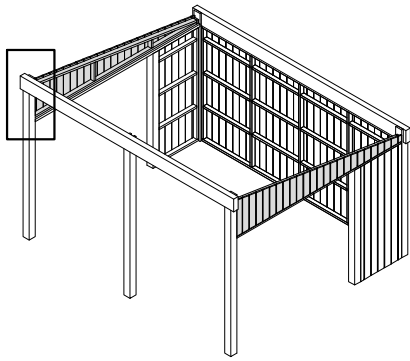
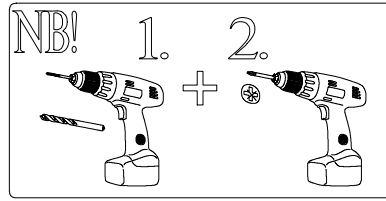

Det 6

Det 27 - 2 pcs
F5 - 12 pcs

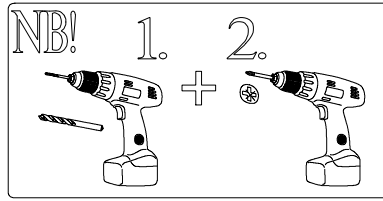

12

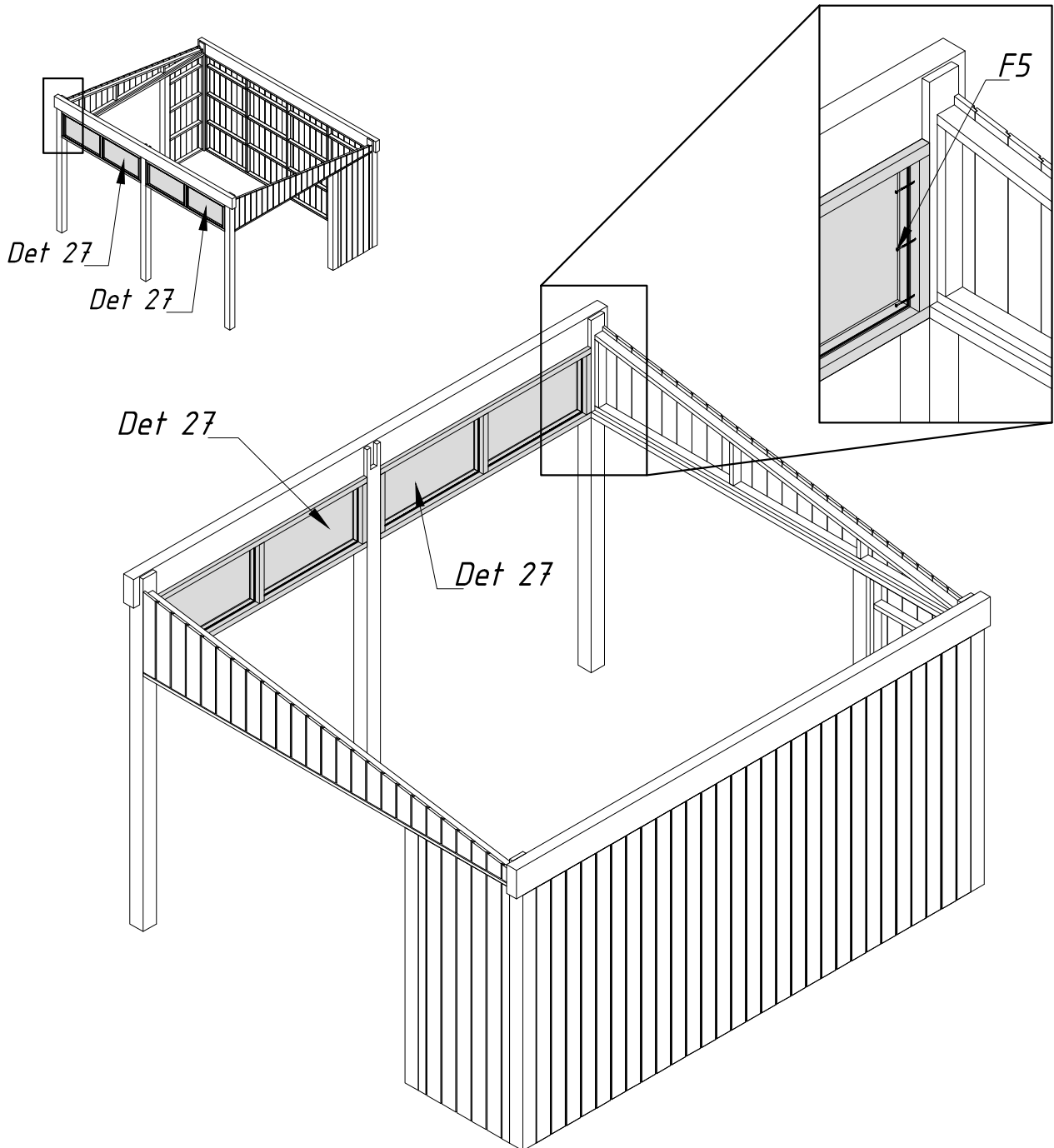

Det 19 - 2 pcs
F2 - 8 pcs
F4 - 10 pcs

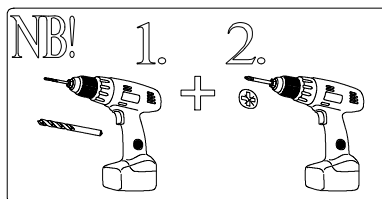

13

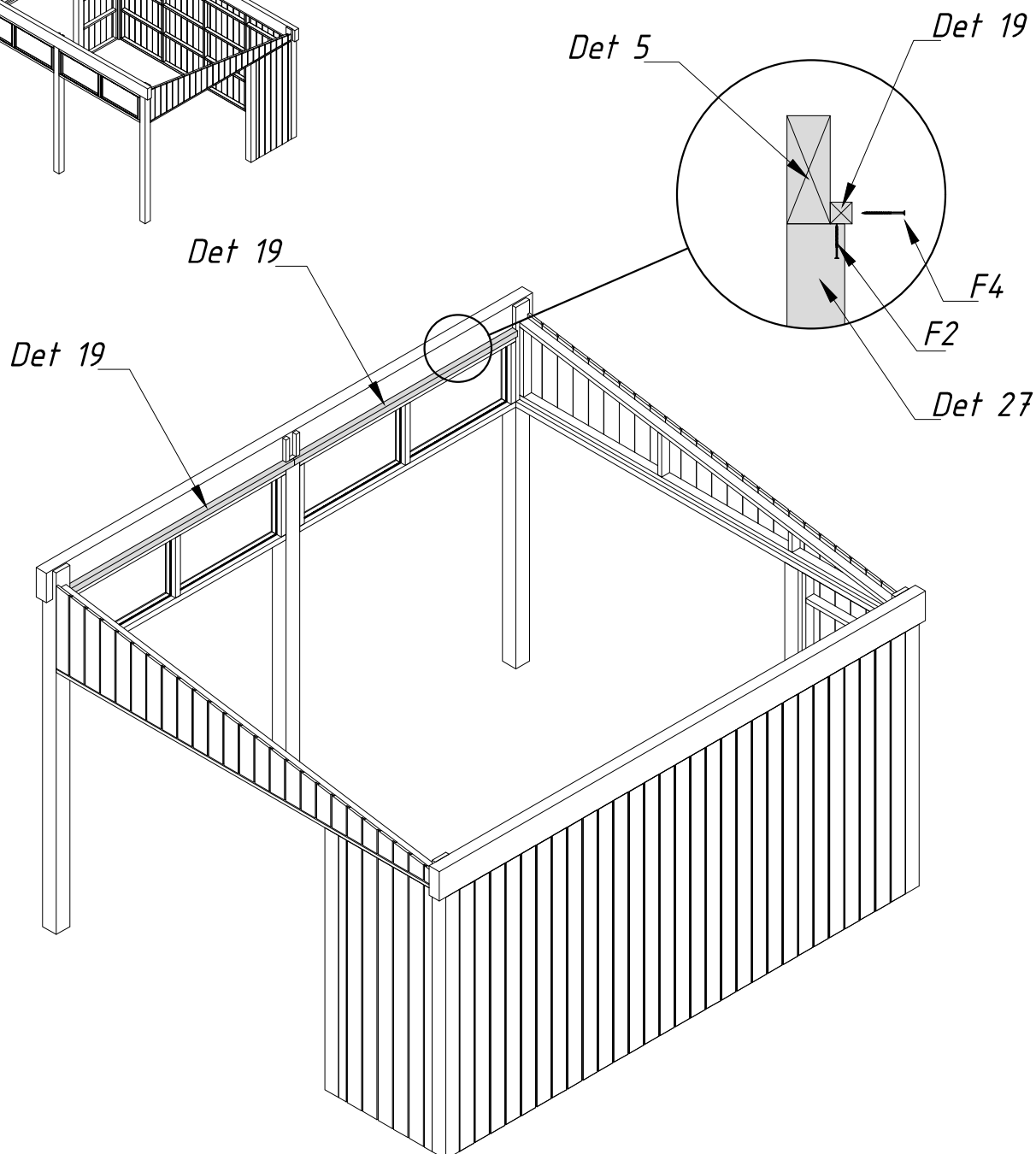
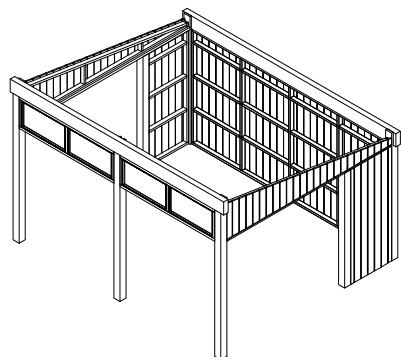

Det 20 - 1 pcs
F4 - 10 pcs

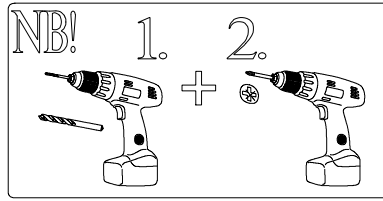

14

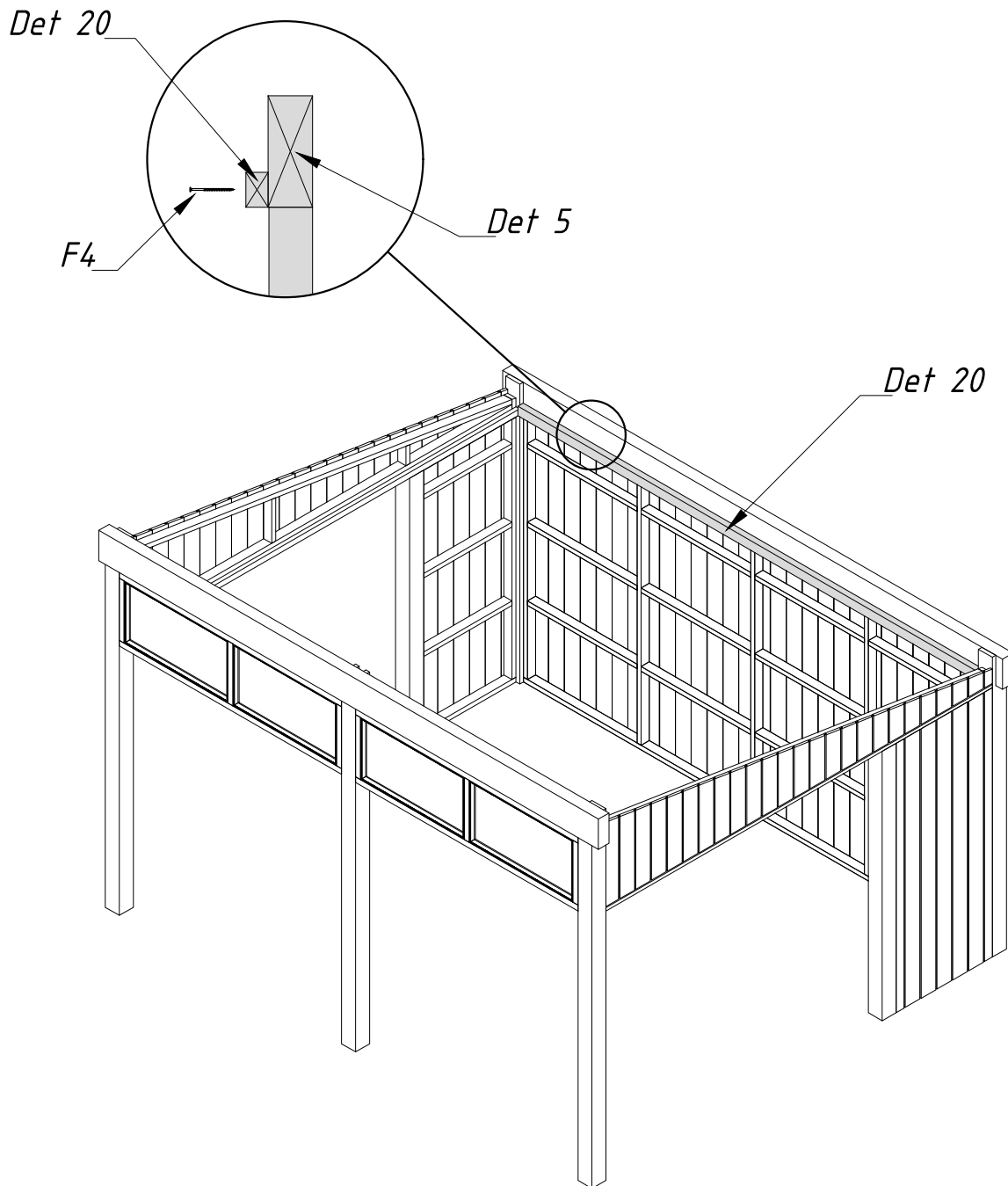

- Det 21 - 3 pcs
- Det 22 - 2 pcs
- F1 - 10 pcs
- F6 - 20 pcs

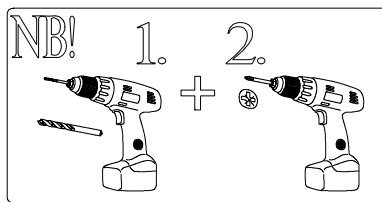

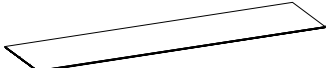
Nova 13,0 m2: Roofing set			
Pos nr	Detail	Dimensions (mm)	
A		16 x 1048 x 3800	

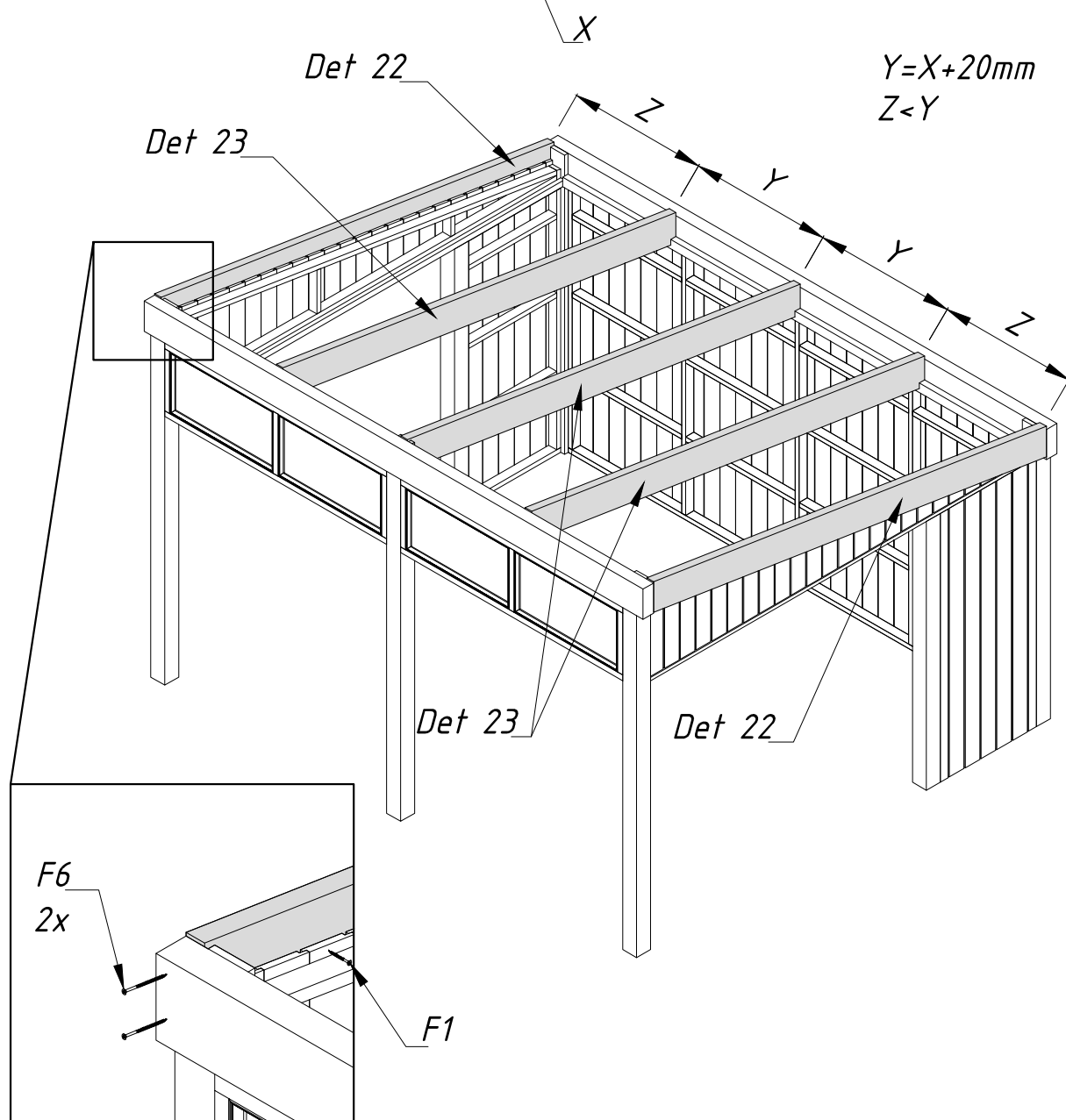

Det 23 - 2 pcs
F2 - 16 pcs

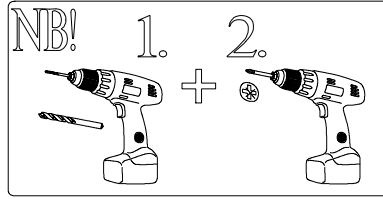

16

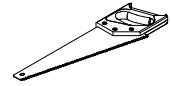

A = Y-56 mm
B = Z-56 mm

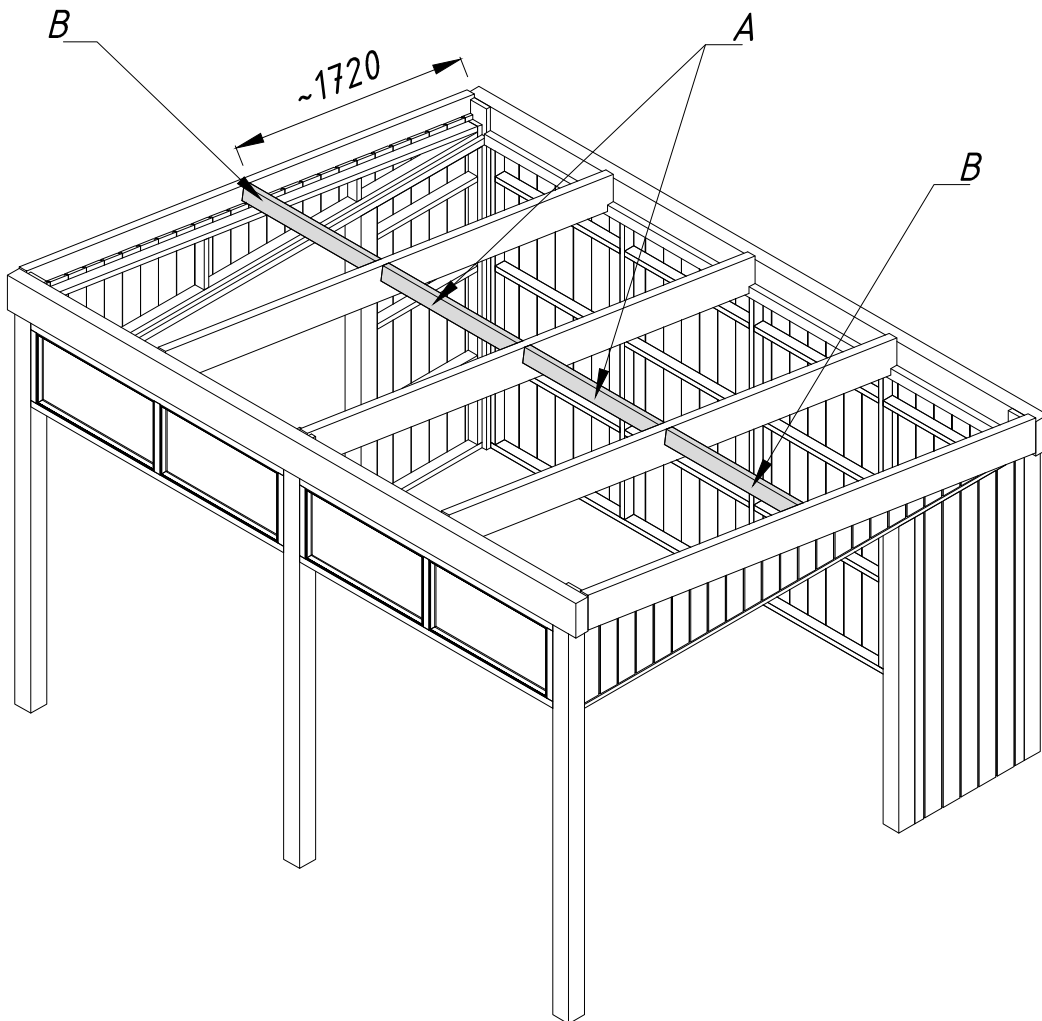

- Det 24 - 1 pcs
- Det 25 - 2 pcs
- Det 26 - 5 pcs
- F1 - 12 pcs
- F2 - 10 pcs
- F5 - 10 pcs

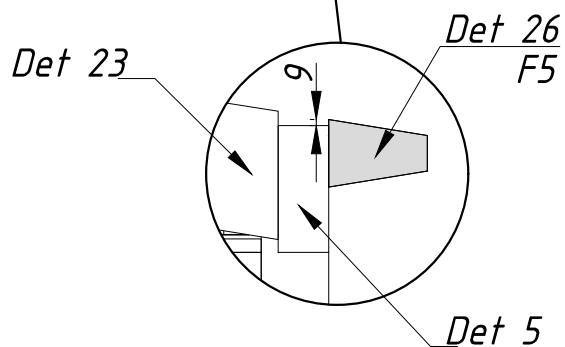
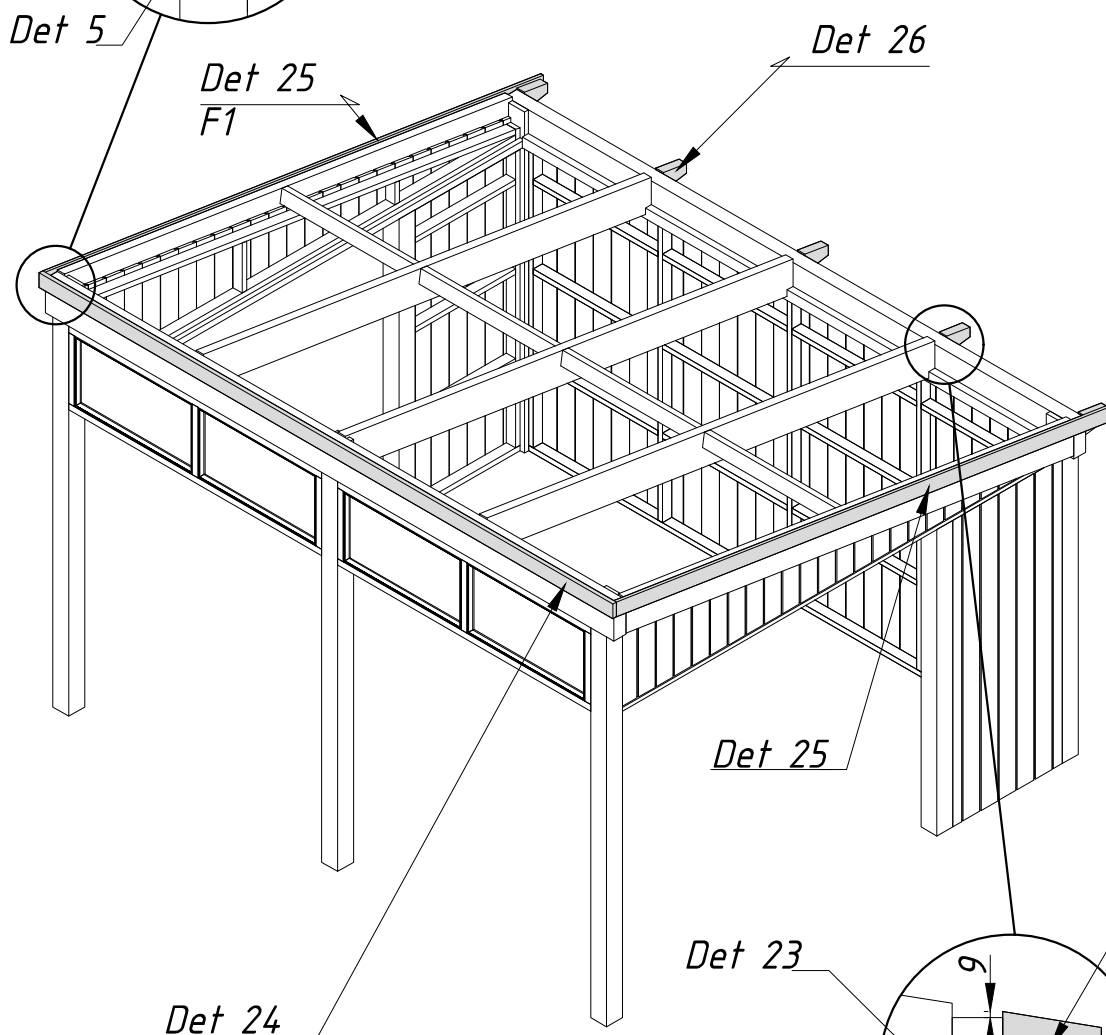
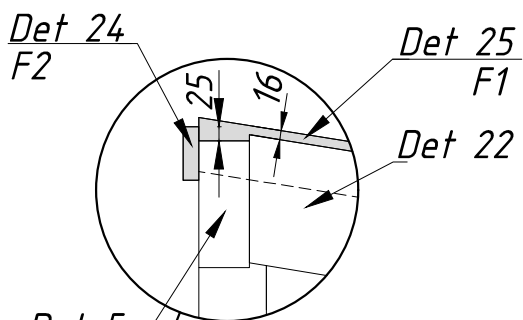
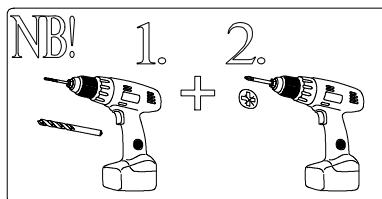

- A - 4 pcs
- F - 1 pcs
- G - 1 pcs

R1

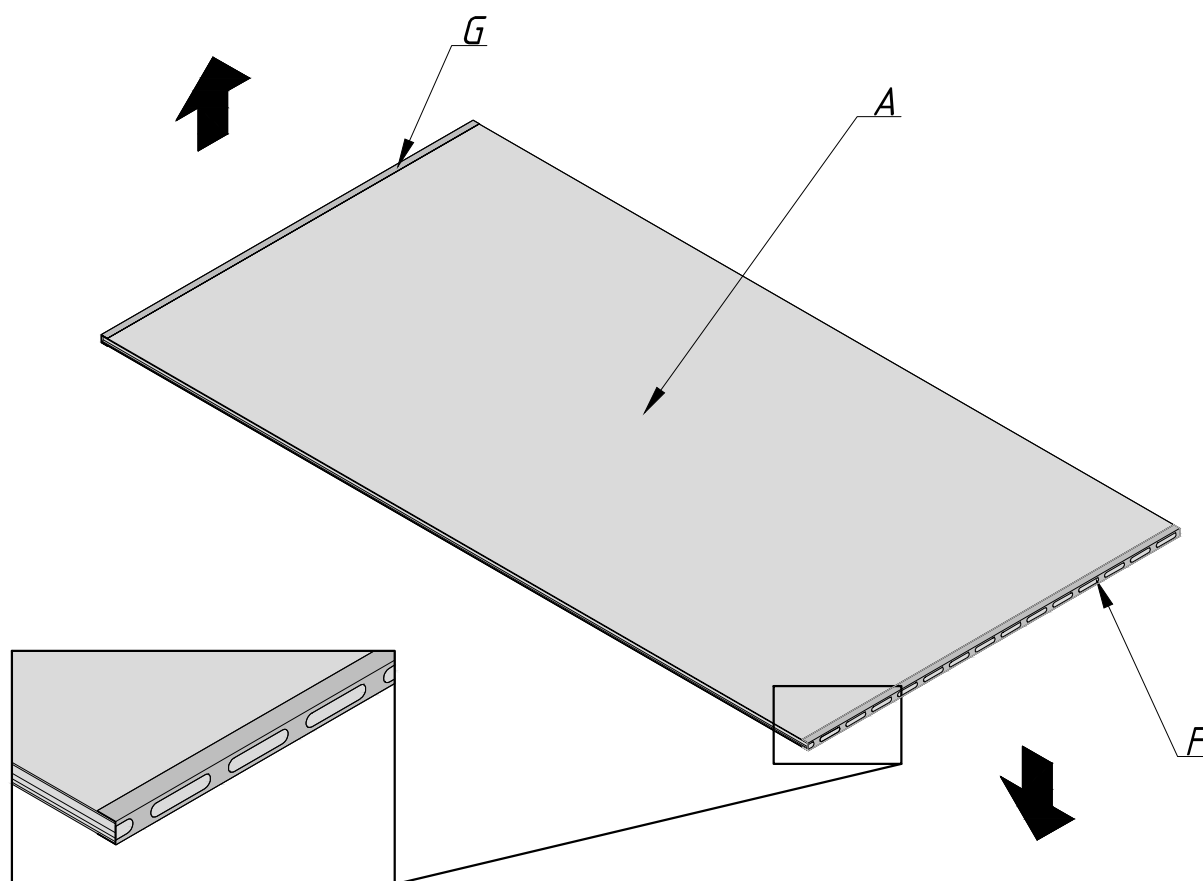

- B - 5 pcs
- E - 40 m

R2

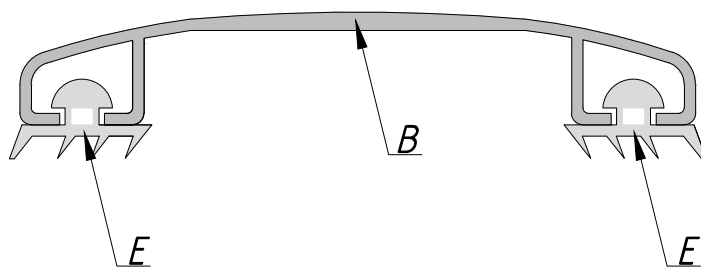

R3

- A - 1 pcs
- B - 1 pcs
- D - 4 pcs
- E - 7,6 m
- H - 13 pcs
- I - 26 pcs

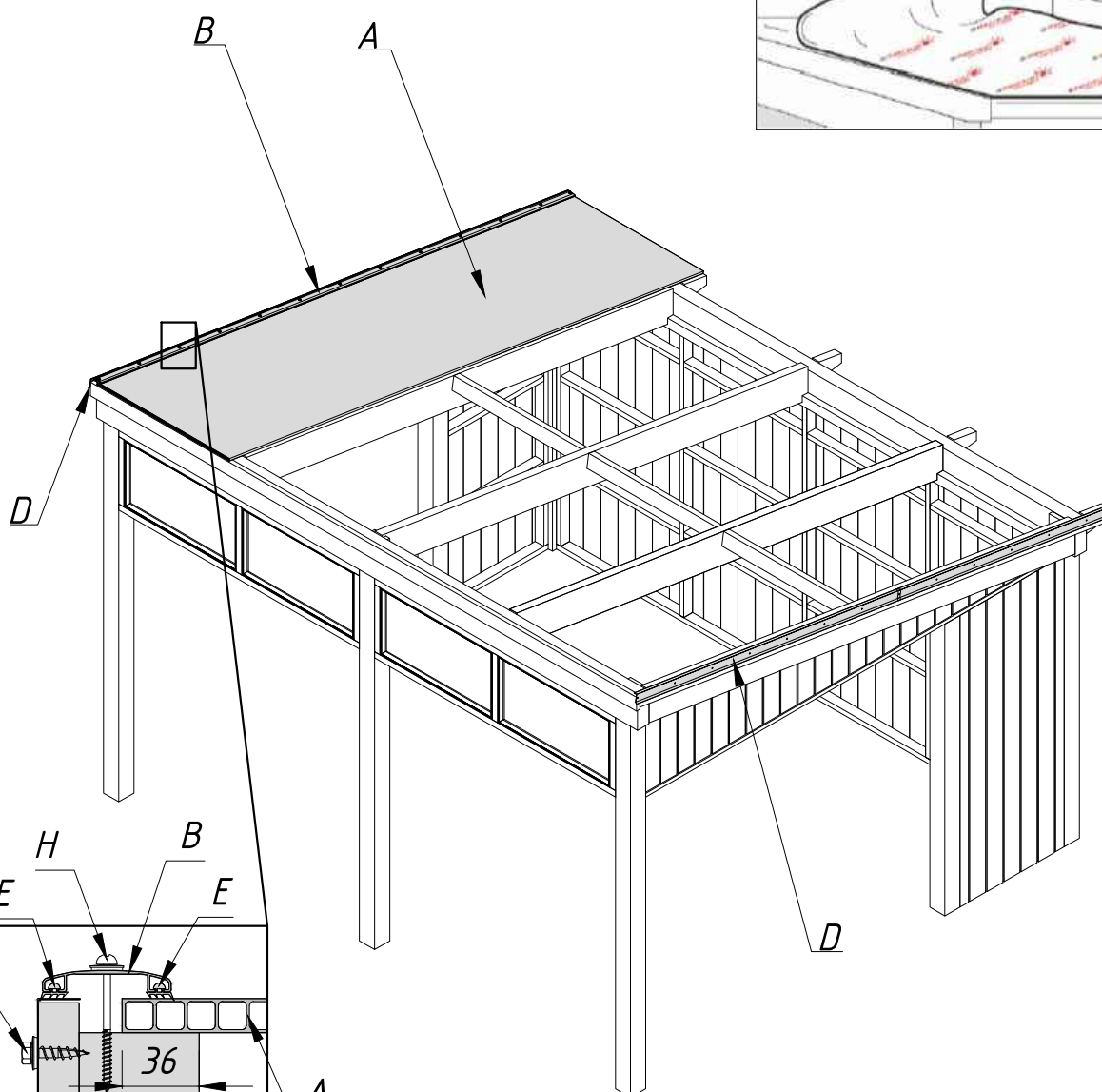
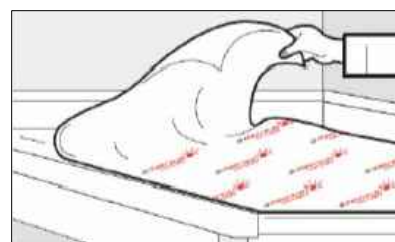

Det 25

Det 22

R4

- A - 3 pcs
- B - 4 pcs
- H - 52 pcs

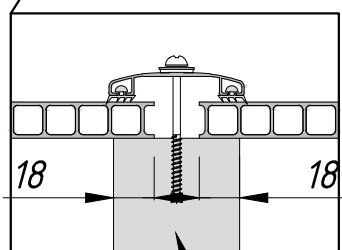
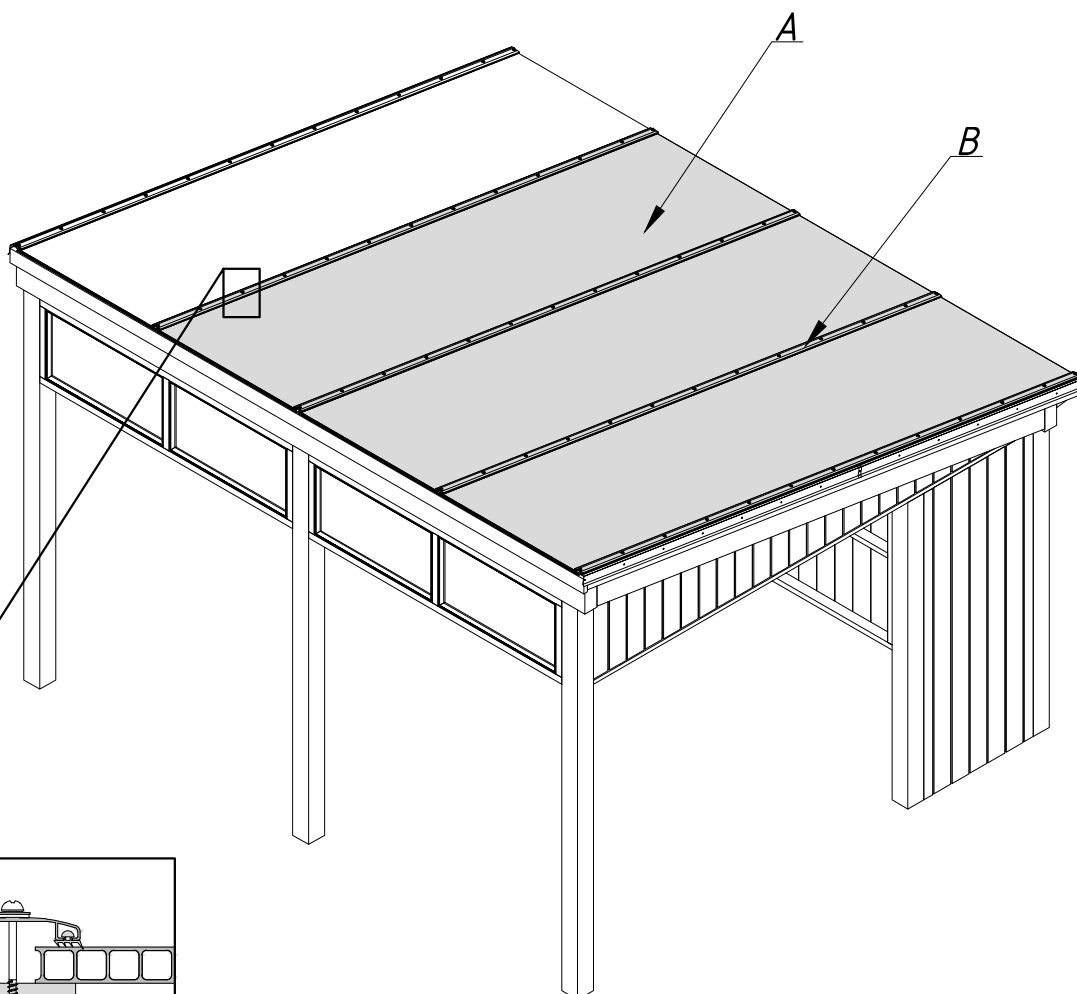
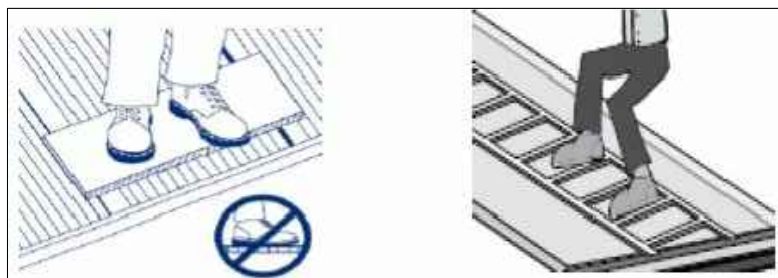

Det 23

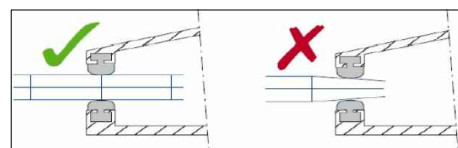

The drawings of the Proplastik OÜ user manual have been used in the manual.

C - 4 pcs



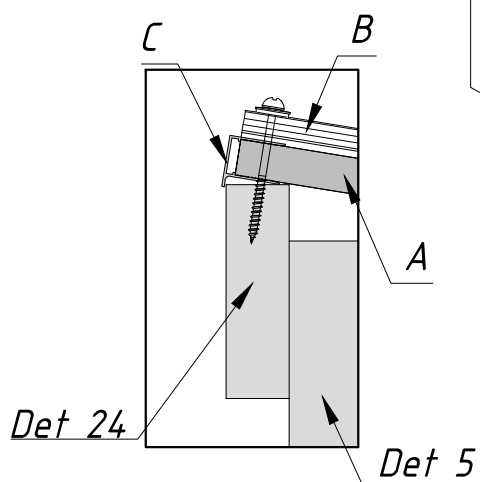
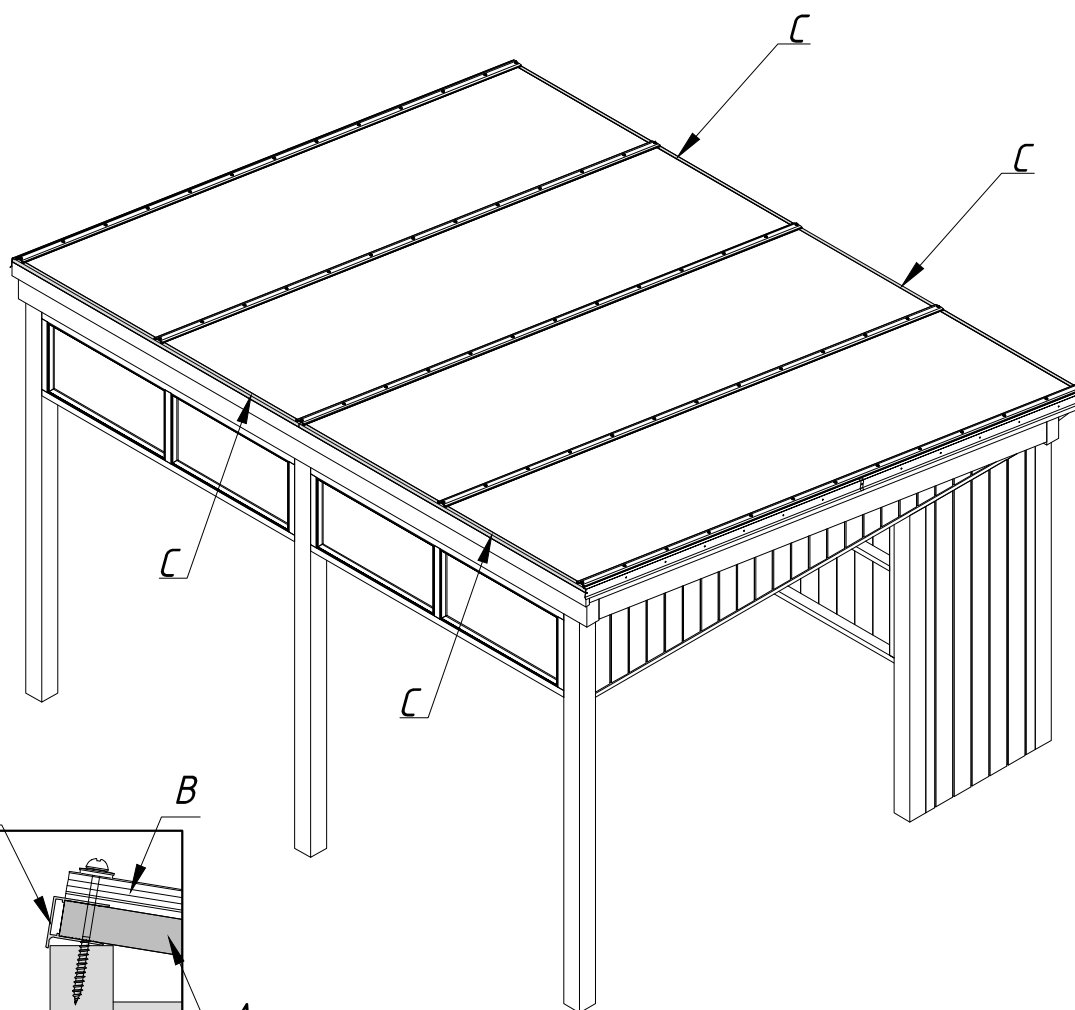





R5

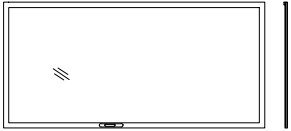

The drawings of the Proplastik OÜ user manual have been used in the manual.

Nova 13,0 m2: Door set

D1/2

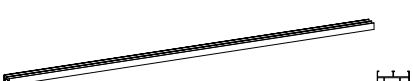
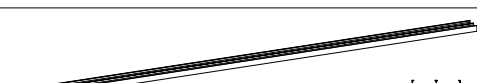
Pos nr	Detail	Dimensions (mm)	Info	Qty
A		28 x 804 x 1947		1
B		28 x 804 x 1947		1
C		35 x 790 x 1947		2
D		28x 804 x 1947		2
E		28 x 946 x 1947		2
F		28 x 946 x 1947		2
G		32 x 92 x 2000		4
H		32 x 62 x 2000		4
I		35 x 60 x 1867		2
J		35 x 90 x 2330		2
K		34 x 60 x 1867		2
L		34 x 90 x 2330		2

D1

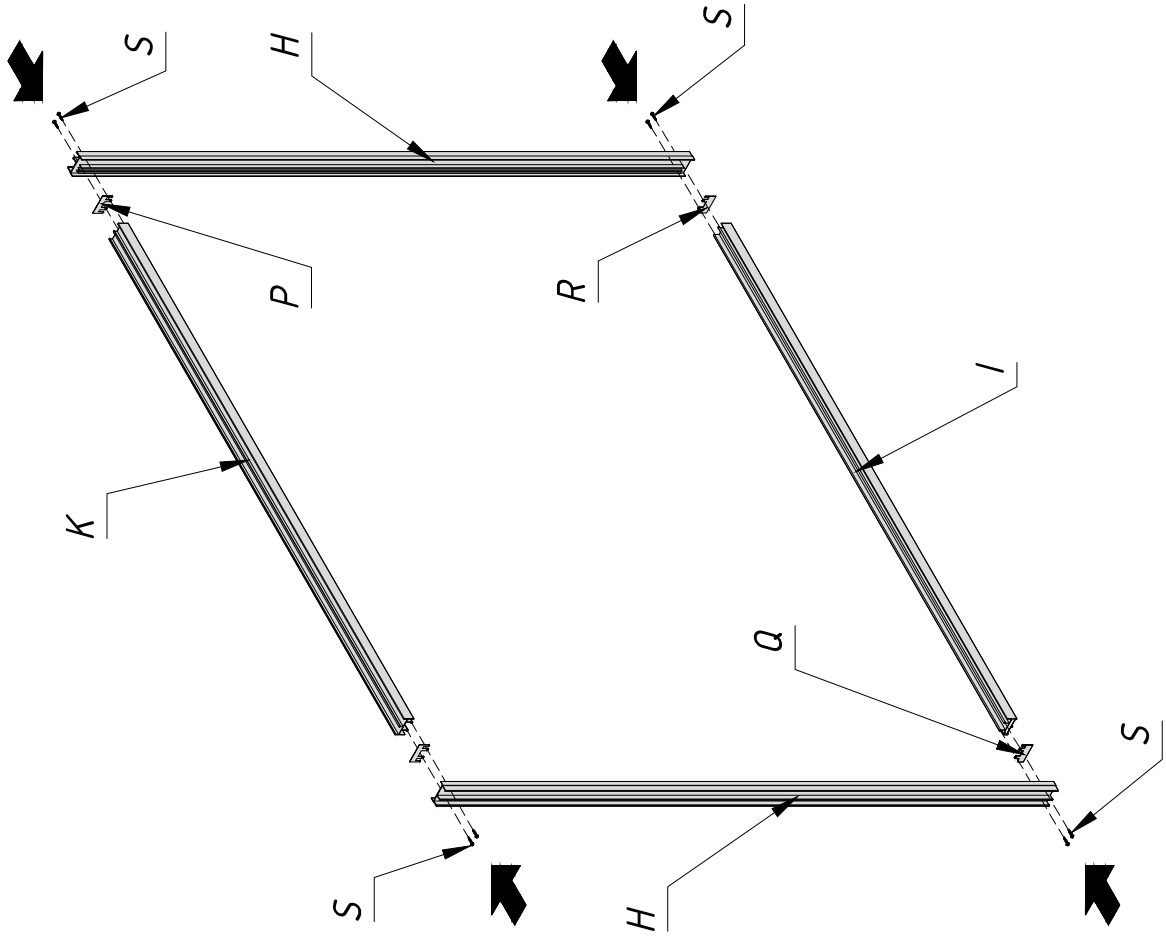

- H - 4 pcs
- I - 2 pcs
- K - 2 pcs
- P - 4 pcs
- Q - 2 pcs
- R - 2 pcs
- S - 16 pcs

D2

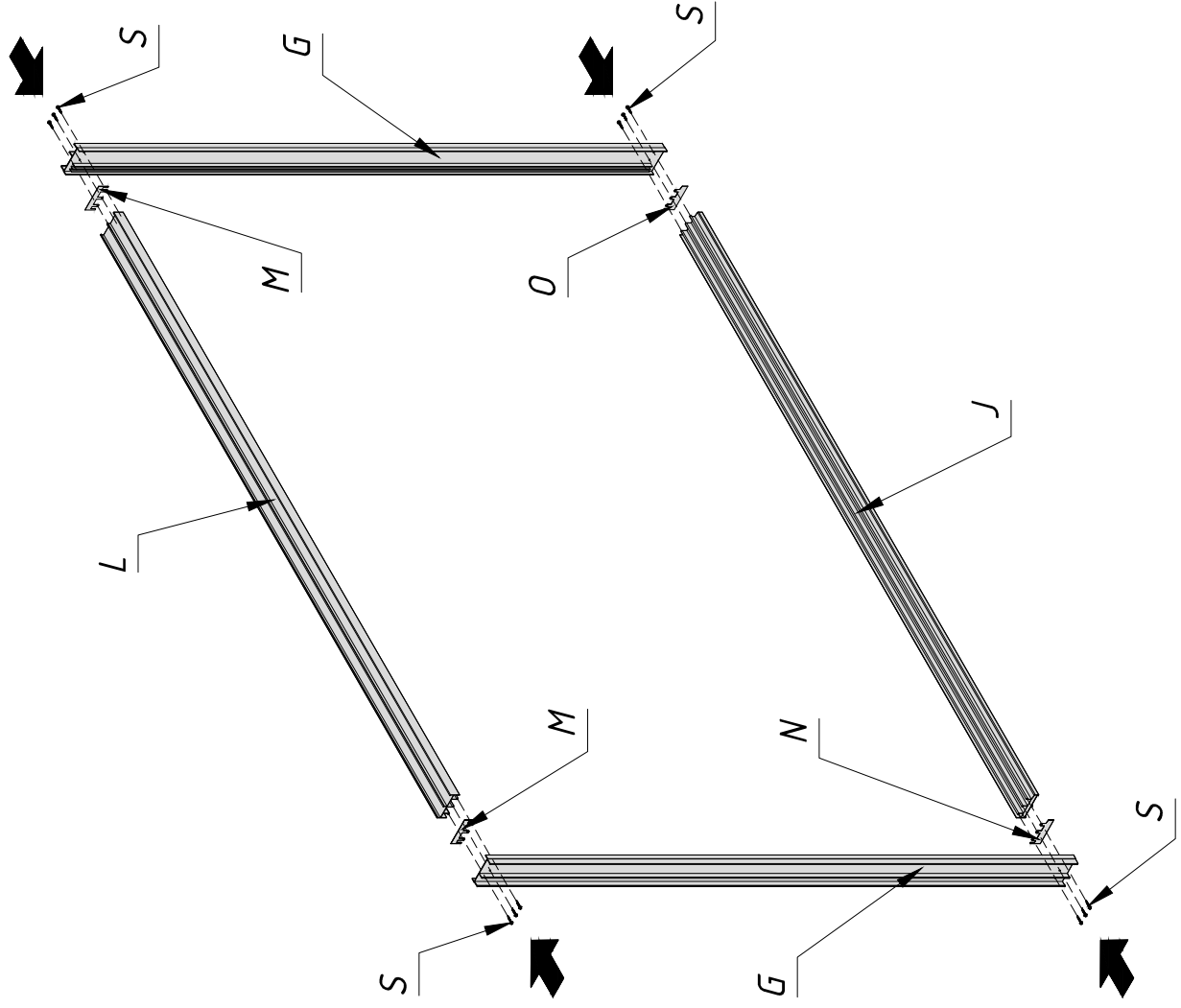

- G - 4 pcs
- J - 2 pcs
- L - 2 pcs
- M - 4 pcs
- N - 2 pcs
- O - 2 pcs
- S - 24 pcs

D3

- $H+H+I+K$ - 2 pcs
- $G+G+J+L$ - 2 pcs
- F3 - 56 pcs

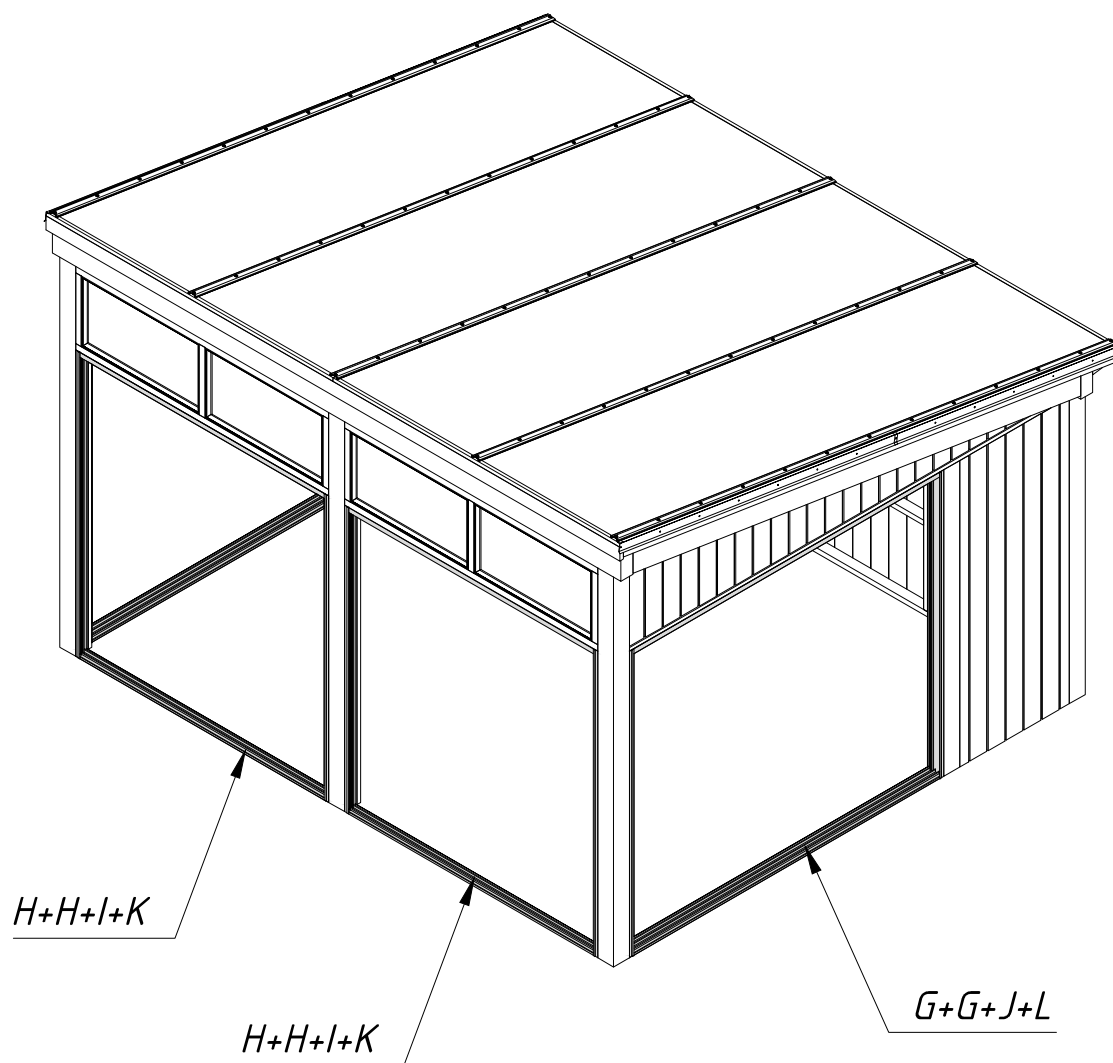
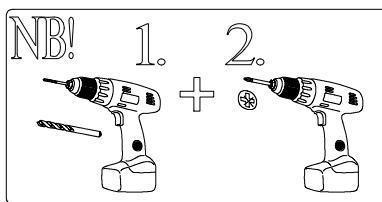

D4

- A - 1 pcs
- B - 1 pcs
- C - 2 pcs
- D - 2 pcs
- E - 2 pcs
- F - 2 pcs

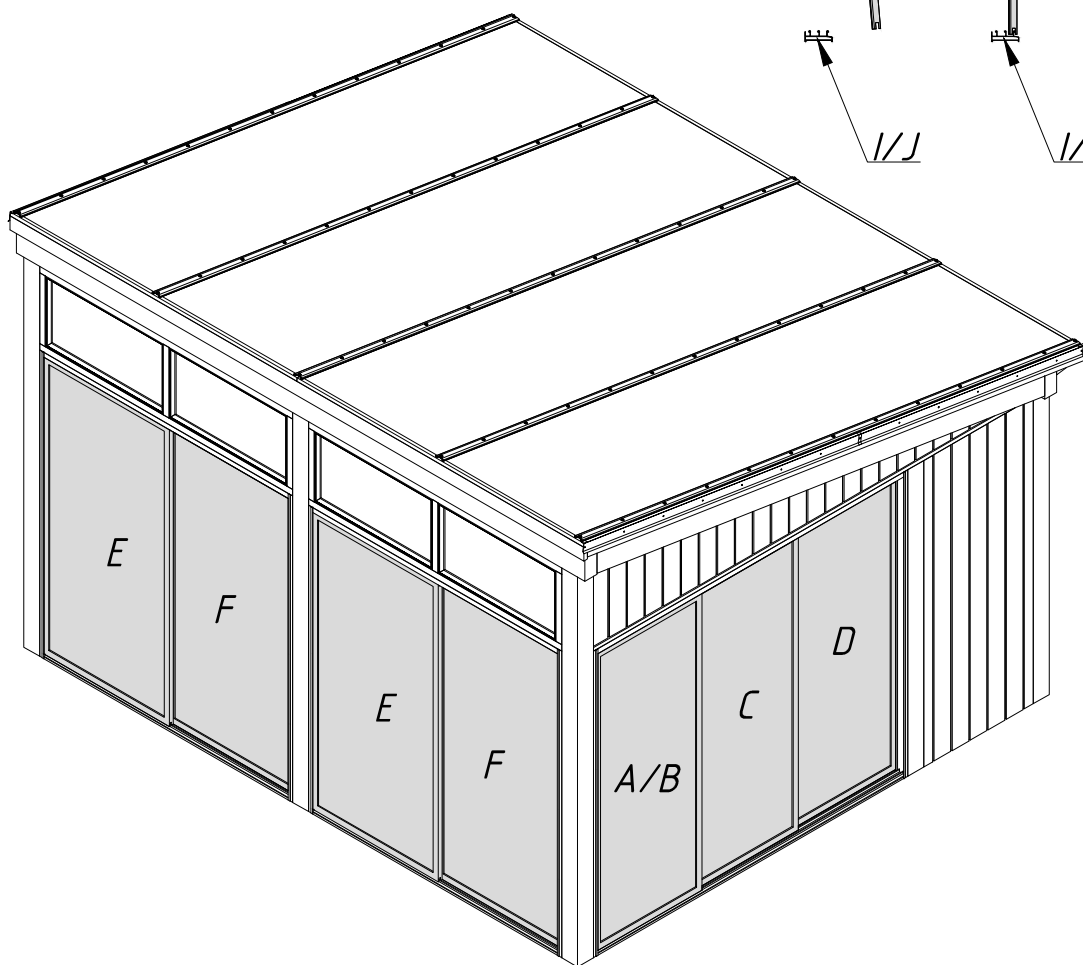
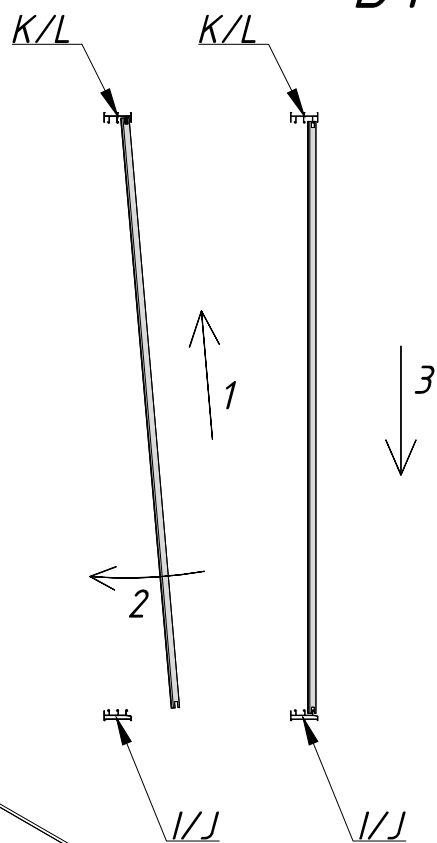

D5

