

# Installation manual

Montageanleitung • Notice de montage • Istruzioni per il montaggio

Manual de montaje • Monteringsanvisning • Installatiegids

## RASMUS 19,0 m<sup>2</sup>

### Log cabin FRD44-3857

Blockhaus • Maisonnette en poutres • Casa di travi • Casa de jardin • Anneks • Tuinhuis

Width 380 x Depth 570 cm

Breite/Tiefe • Largeur/Profondeur • Lunghezza/Profondità • Ancho/Profundidad • Bredde/Dybde • Breedte/Diepte

Log thickness 44 mm

Bohlenstärke • Épaisseur des murs • Spessore delle pareti • Grosor de pared • Tykkelse • Wanddikte











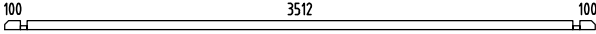
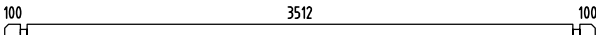
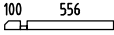
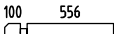
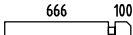
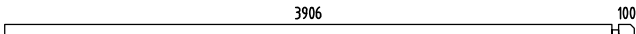

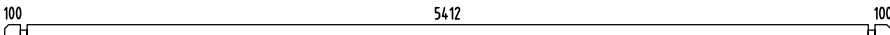
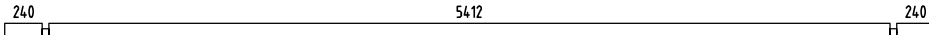
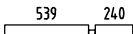

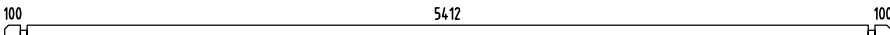
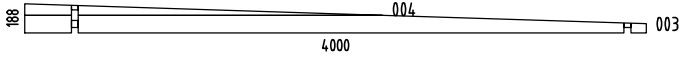
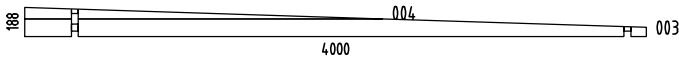
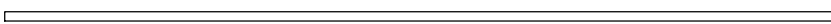
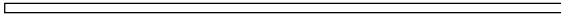





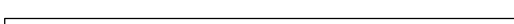

FRO44-3857



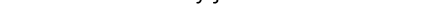

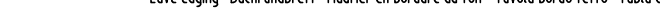



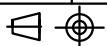

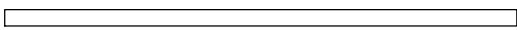
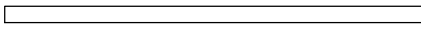







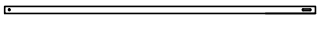

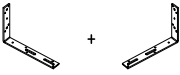

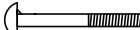
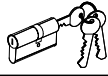

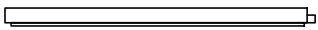
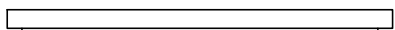
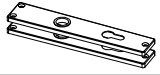
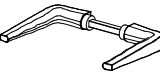





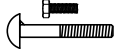
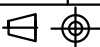



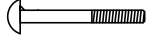

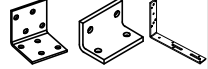

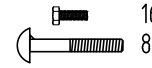

FRO44-3857-1

The producer shall have the right to make technical changes to the product • Technische Änderungen vorbehalten • Le producteur réserve le droit d'effectuer des modifications techniques au produit • Il produttore mantiene il diritto di apportare modifiche tecniche al prodotto • Reservado el derecho a modificaciones técnicas • Produsent forbeholder seg retten til å endre tekniske egenskaper ved produktet • Alle rechten en technische wijzigingen voorbehouden

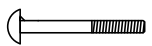
Pos	SPECIFICATION-STÜCKLISTE-NOMENCLATURE-ELEMENTI-ESPECIFICACIÓN "FRD44-3857"	Pcs	Profile (mm)	Length (mm)
001		1	44x57	3800
002		19	44x114	3800
005		2	44x57	700
006		34	44x114	700
007		22	44x114	810
008		12	44x114	4050
009		10	44x114	810
010		18	44x114	5700
011		1	44x114	5980
012		4	44x114	823
013		14	44x114	539
014		1	44x114	5700
W1-1		1		
W2-1		1		
AR1	Foundation- Fundament- Fondation- Fondazione- Vigas de cimentación 	2	80x60	5330
AR2	Foundation- Fundament- Fondation- Fondazione- Vigas de cimentación 	2	80x60	3590
CoB2	Covering board- Deckbrett- Madrier de couverture- Tavola di copertura- Listón de cubierta 	2	70x19	4240
CoB1	Covering board- Deckbrett- Madrier de couverture- Tavola di copertura- Listón de cubierta 	4	70x19	2940
EaE9	Eave edging- Dachrandbrett- Madrier en bordure du toit- Tavola bordo tetto- Tabla de valadizo  	2	19x114	4240
EaE8	Eave edging- Dachrandbrett- Madrier en bordure du toit- Tavola bordo tetto- Tabla de valadizo  	2	19x114	4240
EaE4	Eave edging- Dachrandbrett- Madrier en bordure du toit- Tavola bordo tetto- Tabla de valadizo  	2	19x114	3295
EaE2	Eave edging- Dachrandbrett- Madrier en bordure du toit- Tavola bordo tetto- Tabla de valadizo  	2	19x114	3295
EaE1	Eave edging- Dachrandbrett- Madrier en bordure du toit- Tavola bordo tetto- Tabla de valadizo  	2	19x114	2685
EaE5	Eave edging- Dachrandbrett- Madrier en bordure du toit- Tavola bordo tetto- Tabla de valadizo  	2	19x114	2685
EaE7	Eave edging- Dachrandbrett- Madrier en bordure du toit- Tavola bordo tetto- Tabla de valadizo  	2	19x105	4240

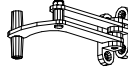
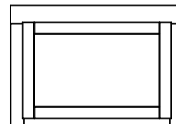

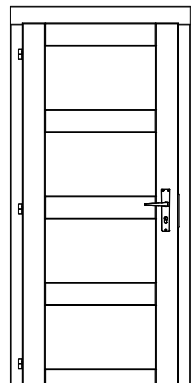
Pos	SPECIFICATION-STÜCKLISTE-NOMENCLATURE-ELEMENTI-ESPECIFICACIÓN "FRD44-3857"	Pcs	Profile (mm)	Length (mm)
EaE3	Eave edging- Dachrandbrett- Madrier en bordure du toit- Tavola bordo tetto- Tabla de valadizo 	2	19x105	3295
EaE6	Eave edging- Dachrandbrett- Madrier en bordure du toit- Tavola bordo tetto- Tabla de valadizo 	2	19x105	2685
RoR2	Rafter- Sparre- Chevron- Trave- Cabrio 	8	70x140	4006
RoR1	Rafter- Sparre- Chevron- Trave- Cabrio 	8	44x120	240
SP2	Support brace- Stützleiste- Baguette de support- Listello di supporto- Listón de soporte 	14	32x40	330
SP3	Support brace- Stützleiste- Baguette de support- Listello di supporto- Listón de soporte 	12	32x40	300
SP1	Support brace- Stützleiste- Baguette de support- Listello di supporto- Listón de soporte 	14	32x40	260
RB2-1	Roof board- Dachbrett- Madrier du toit- Tavola tetto- Tabla de tejado 	45	89x19	3290
RB2-2	Roof board- Dachbrett- Madrier du toit- Tavola tetto- Tabla de tejado 	45	89x19	2690
StB1-1	Storm brace- Sturmleiste- Protection contre le vent- Antivento- Protector contra tormentas 	4	25x45	2220
Fim	-Fixing kit- Befestigungsset- Moyens de fixation- Materiale di fissaggio- Kit de fijación 	1	USE	
QKSP0 6x18Zn	Bolt -Schloss-schraube -Boulon- Bullone- Perno- M6x18mm KSP0 	8		
QPUP 06x60	Bolt -Schloss-schraube -Boulon- Bullone- Perno- M6x60mm PUP0 	8	 + Wall B	
QPUP 08x80	Bolt -Schloss-schraube -Boulon- Bullone- Perno- M8x80mm PUP0 	8	StB1-1+ Wall	
QULSy damik 30/35	Cylinder- Zylinderschloss- Serrure a mortaiser- Serratura a cilindro- Bombin- 30.35 	1	U44-15L	
KULEN GP-37	Detail- Detail- Detail- Dettaglio- Detalle- KULENGP-37 	1	Wall2	
KULEN GV-37	Detail- Detail- Detail- Dettaglio- Detalle- KULENGV-37 	1	Wall2	
KULEN GY-25	Detail- Detail- Detail- Dettaglio- Detalle- KULENGY-25 	1	Wall2	
QULKat eHOBEk	Door fittings- Türbeschlag- Ferrure- Ferramenta porta- Manilla puerta- QULKateHOBEk 	1	U44-15L	
QULli nkHOBE	Door fittings- Türbeschlag- Ferrure- Ferramenta porta- Manilla puerta- QULlinkHOBE 	1	U44-15L	
QNU2 02040	L-iron- Winkel- Angle -Angolo- Angulo 20x20x40 	2	002 (W2)	
QNU4 04040	L-iron- Winkel- Angle -Angolo- Angulo 40x40x40 	32	ARx+Wall (16) RoR2+Wall (16)	
QNU22 015030	L-iron- Winkel- Angle -Angolo- Angulo 220x150x30 	8	SP2+WallB	
QNA3x 70Zn	Nail- Nagel- Clou- Chiodo- Clavo- 3x70mm 	1000	RB2-x + RoR2 RB2-x + 012/013	
QMU6	Nut- Schraubenmutter- Écrou- Dado- Tuerca- M6mm 	16		
	Object name "FRD44-3857"	Page		2/3

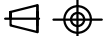
Pos	SPECIFICATION-STÜCKLISTE-NOMENCLATURE-ELEMENTI-ESPECIFICACIÓN "FRD44-3857"		Pcs	
QMU8	Nut- Schraubenmutter- Écrou- Dado- Tuerca- M8mm		8	
QKR4 5x40ZN	Screw- Schraube- Vis- Vite- Tornillo- 4.5x40mm		300	
QKR4 5x50ZN	Screw- Schraube- Vis- Vite- Tornillo- 4.5x50mm		350	EaEx; CoBx; ...
QKR4 5x70ZN	Screw- Schraube- Vis- Vite- Tornillo- 4.5x70mm		10	001; 005; 012
QKR5 x90ZN	Screw- Schraube- Vis- Vite- Tornillo- 5x90mm		100	012/013+RoR2 SP1&3+RoR2 KULENGY-25
QKR6x 120ZN	Screw- Schraube- Vis- Vite- Tornillo- 6x120mm		36	ARx 8pcs Wall+RoR1 16pcs Wall+SP3 12pcs
QSE6x18	Washer- Dichtscheibe- Joint- Rondella- Arandela- 6x18mm		24	 16pcs 8pcs
QSE8x22	Washer- Dichtscheibe- Joint- Rondella- Arandela- 8x22mm		8	
QALp ainP	Window fittings- Fenstergriff- Poigne de la fenêtre- Maniglia finestra- Manilla- QALpainP		2	A44-21Y
QAF140	Window stop- Fensterfeststelle- Crémaillère- Fissativo finestra- Fijador de ventana- QAF140		2	A44-21Y
A44-21Y	Window - Fenster - Fenetre - Finestra-Ventana 800x534    700x434mm		2	
U44-15L	Door - Tür - Porte - Porta-Puerta 835x1900    735x1831mm		1	
	Object name "FRD44-3857"			Page 3/3

Foundation- Fundament- Fondation- Fondazione- Vigas de cimentación

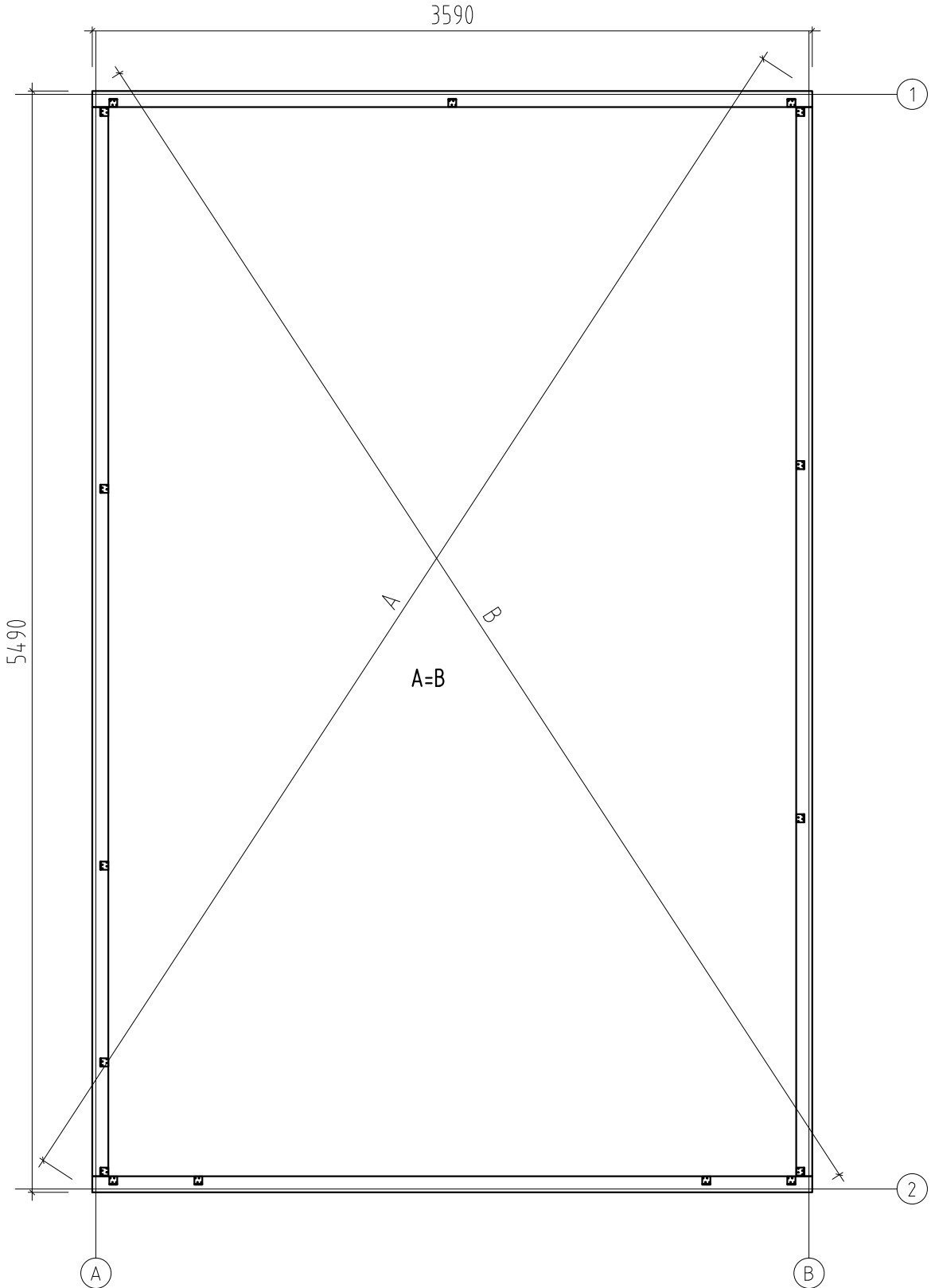



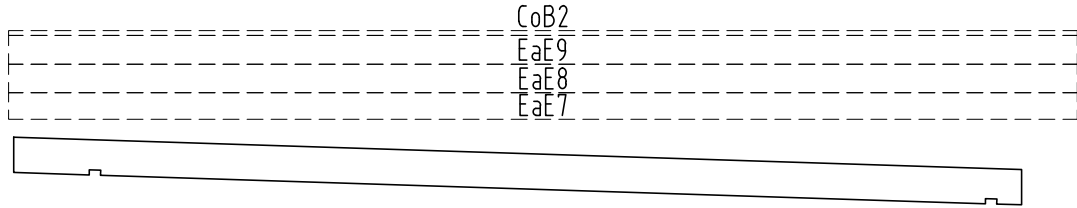

4000

300

21  
20

19  
18  
17  
16  
15  
14  
13  
12  
11  
10  
9  
8  
7  
6  
5  
4  
3  
2  
1

2007

2190

120

004

RoR1

002  
002  
002  
002  
002  
002  
002  
002  
002  
002  
002  
002  
002  
002  
002  
002  
002  
002  
002  
001

2340  
2359

Wall

3512

100 44

3556

44 100

A

B

3800

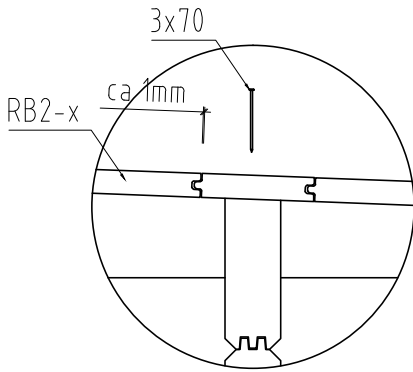
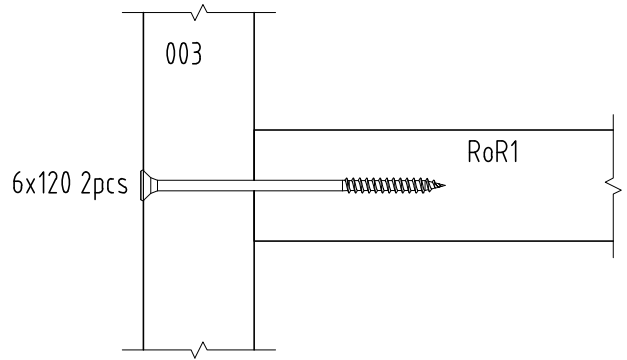

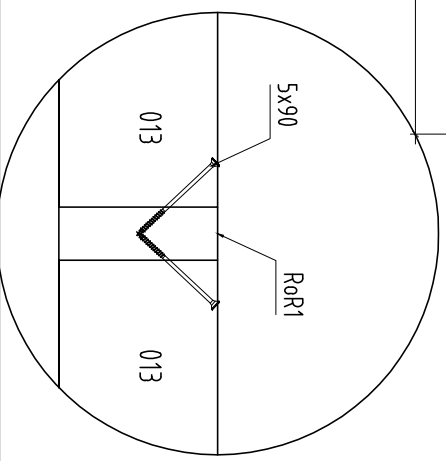
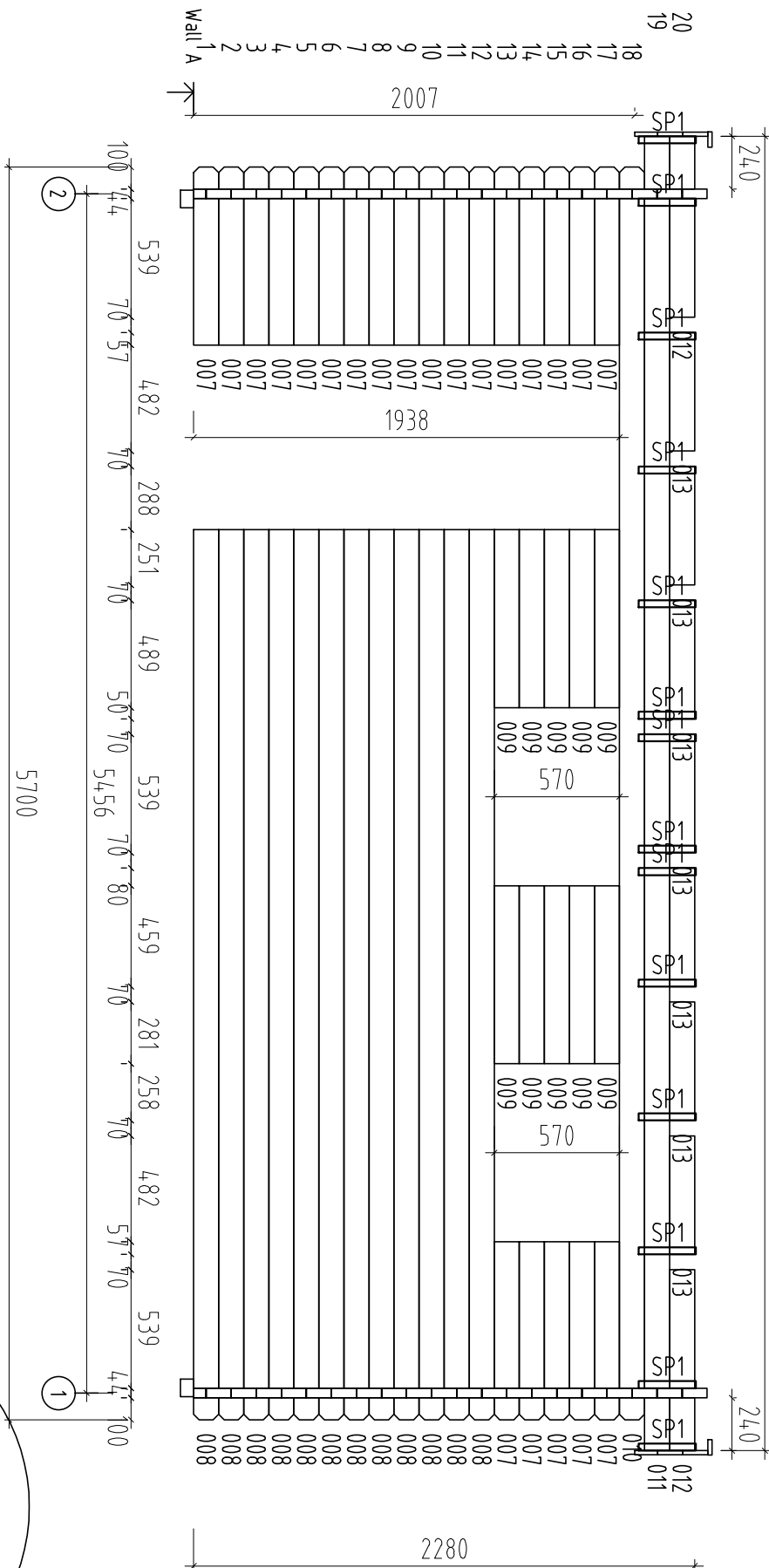
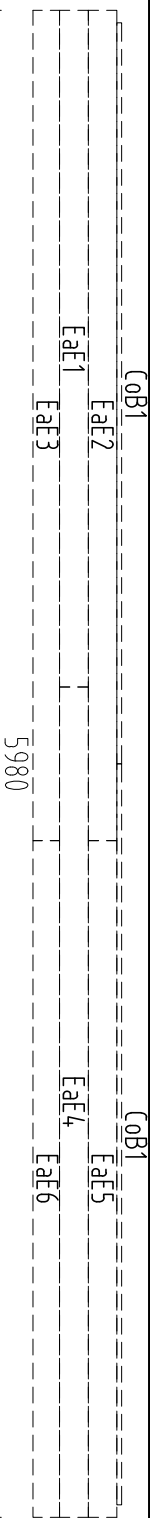



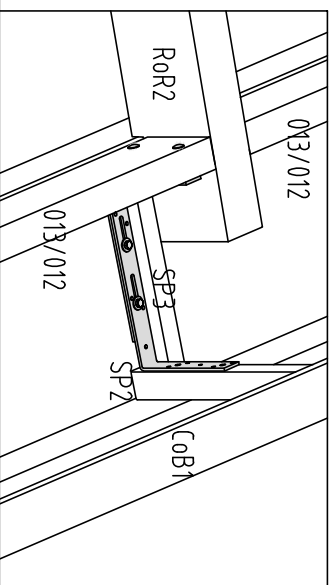
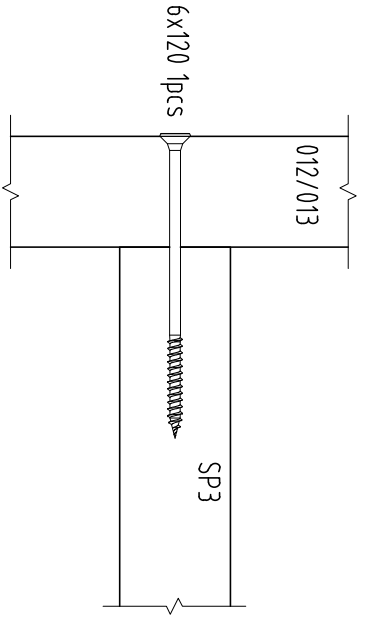
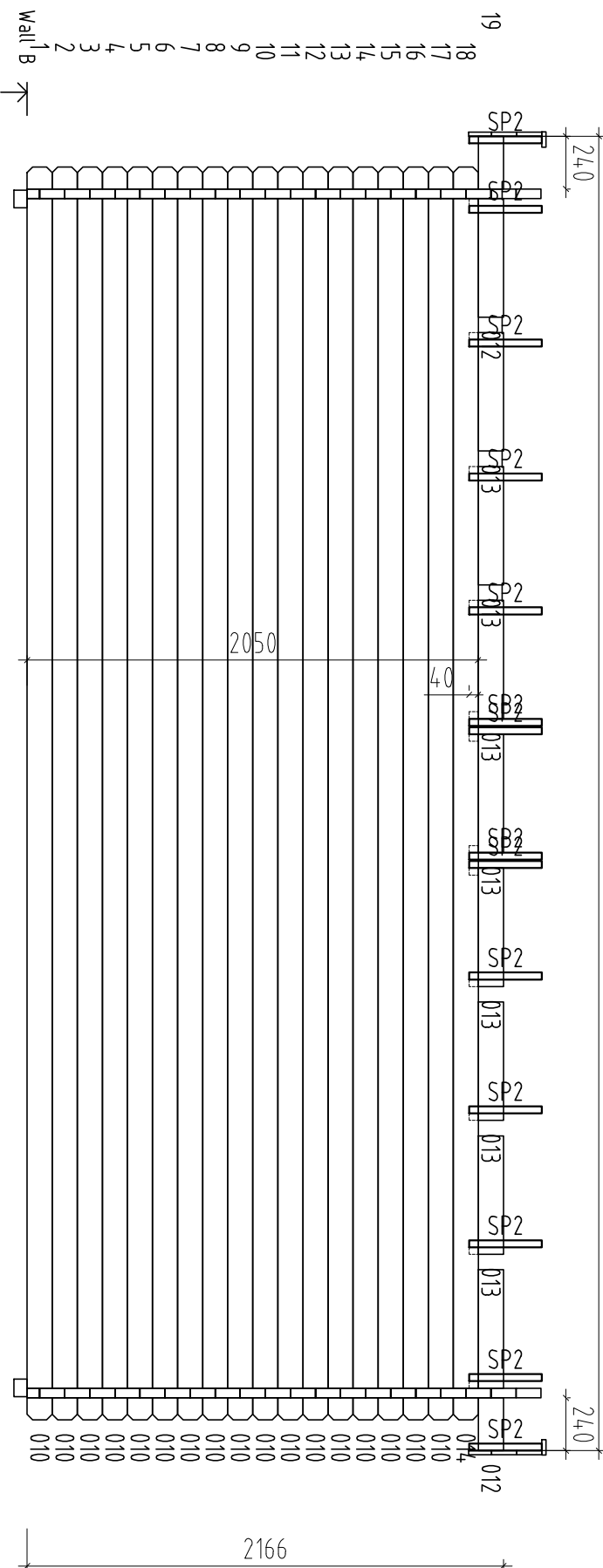
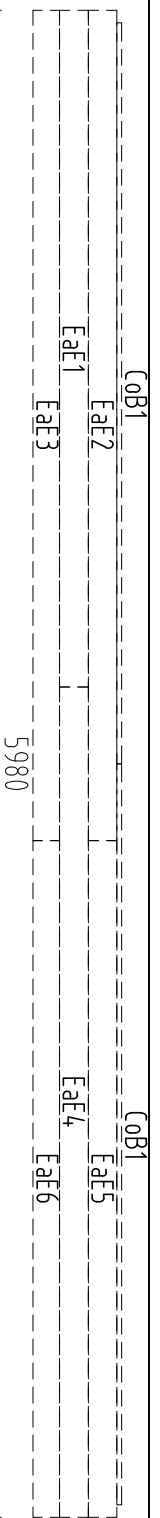

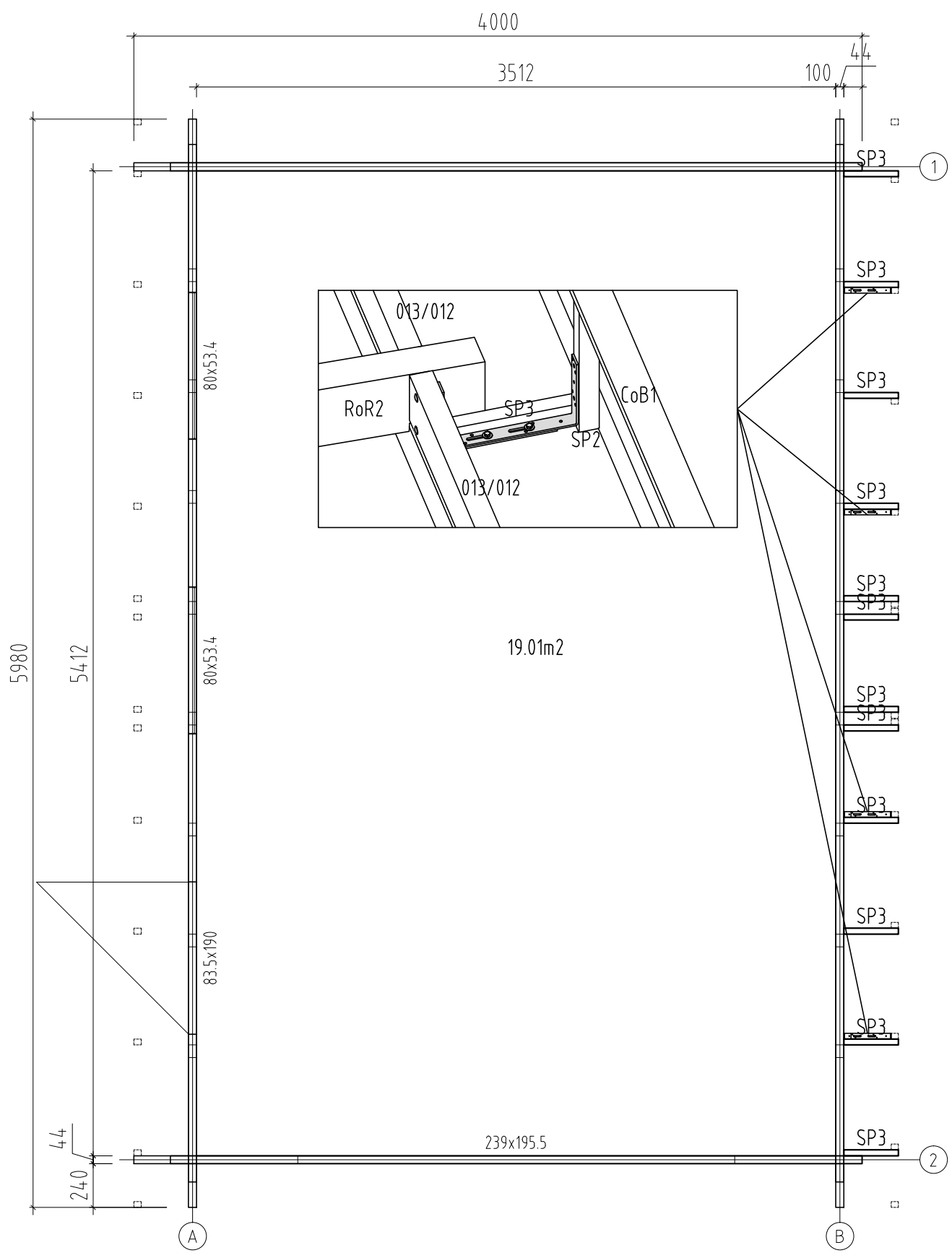

# Rafter- Sparre- Chevron- Trave- Cabrio

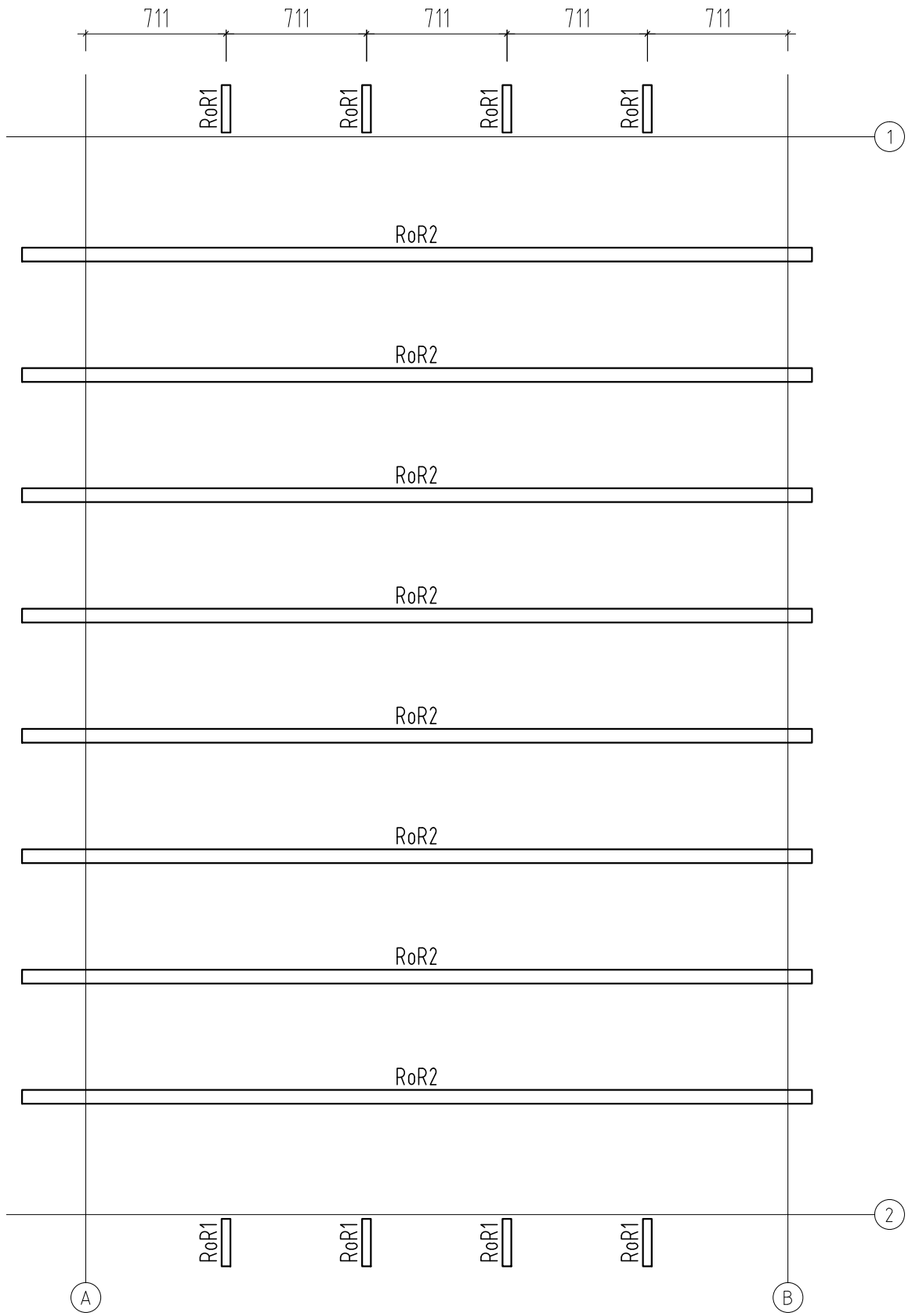

Roof board- Dachbrett- Madrier du toit- Tavola tetto- Tabla de tejado

→ Space between boards  $\approx 1\text{mm}$

