

Installation manual

Montageanleitung • Notice de montage • Istruzioni per il montaggio
Manual de montaje • Monteringsanvisning • Installatiegids • Asennusohje • Installationsmanual

Element house ELD18-4533-2

Elementhaus • Maison à modules • Casetta in elementi • Cobertizo • Redskapsbod • Element huis • Elementti
piharakennus • Friggebod

Width 452 x Depth 330 cm

Breite/Tiefe • Largeur/Profondeur • Lunghezza/Profondità • Ancho/Profundidad • Bredde/Dybde • Breedte/Diepte •
Leveys/Pituus • Bredd/Längd

Log thickness 18 mm

Bohlenstärke • Épaisseur des murs • Spessore delle pareti • Grosor de pared • Tykkelse • Wanddicke •
Seinän paksuus • Väggtjocklek





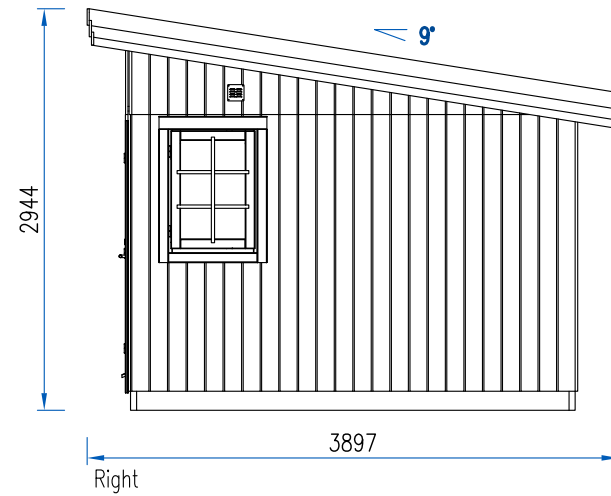
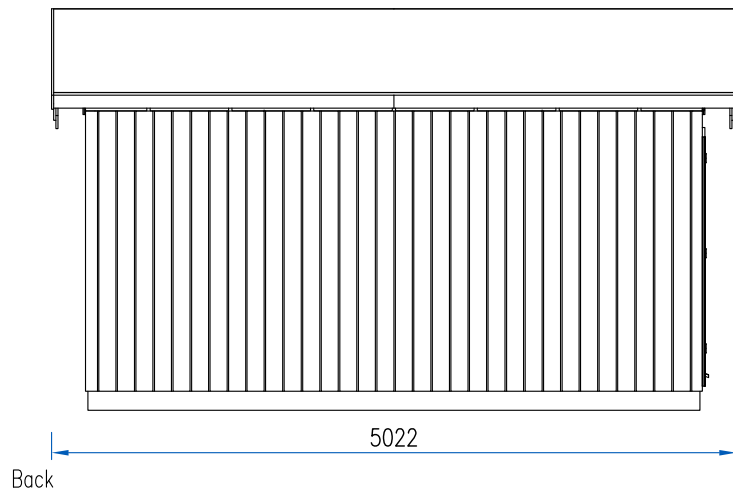
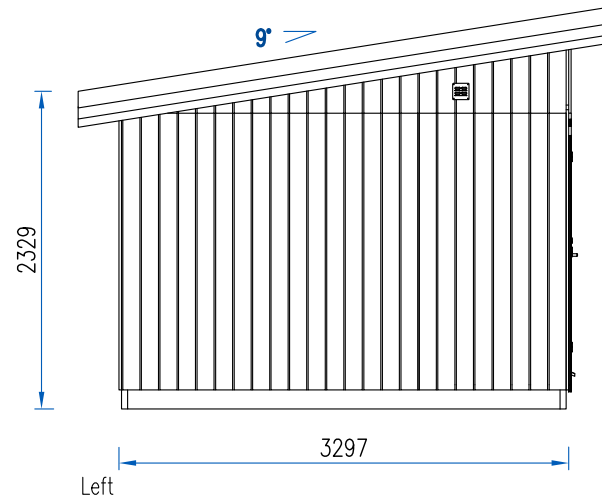
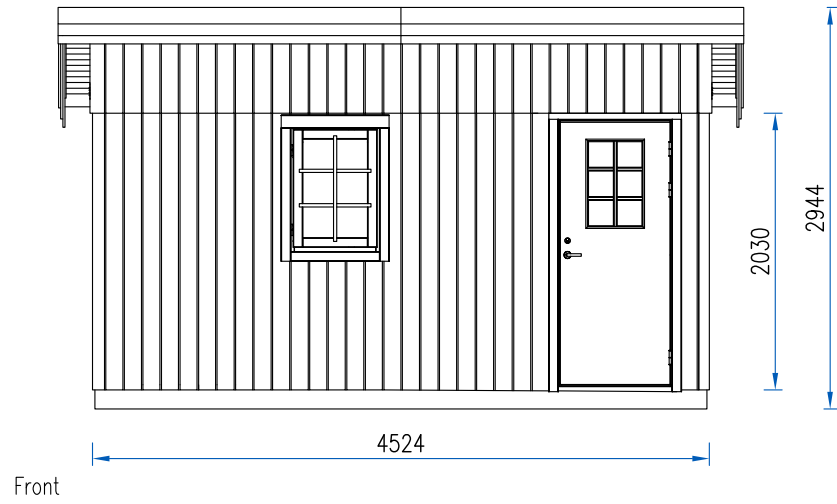



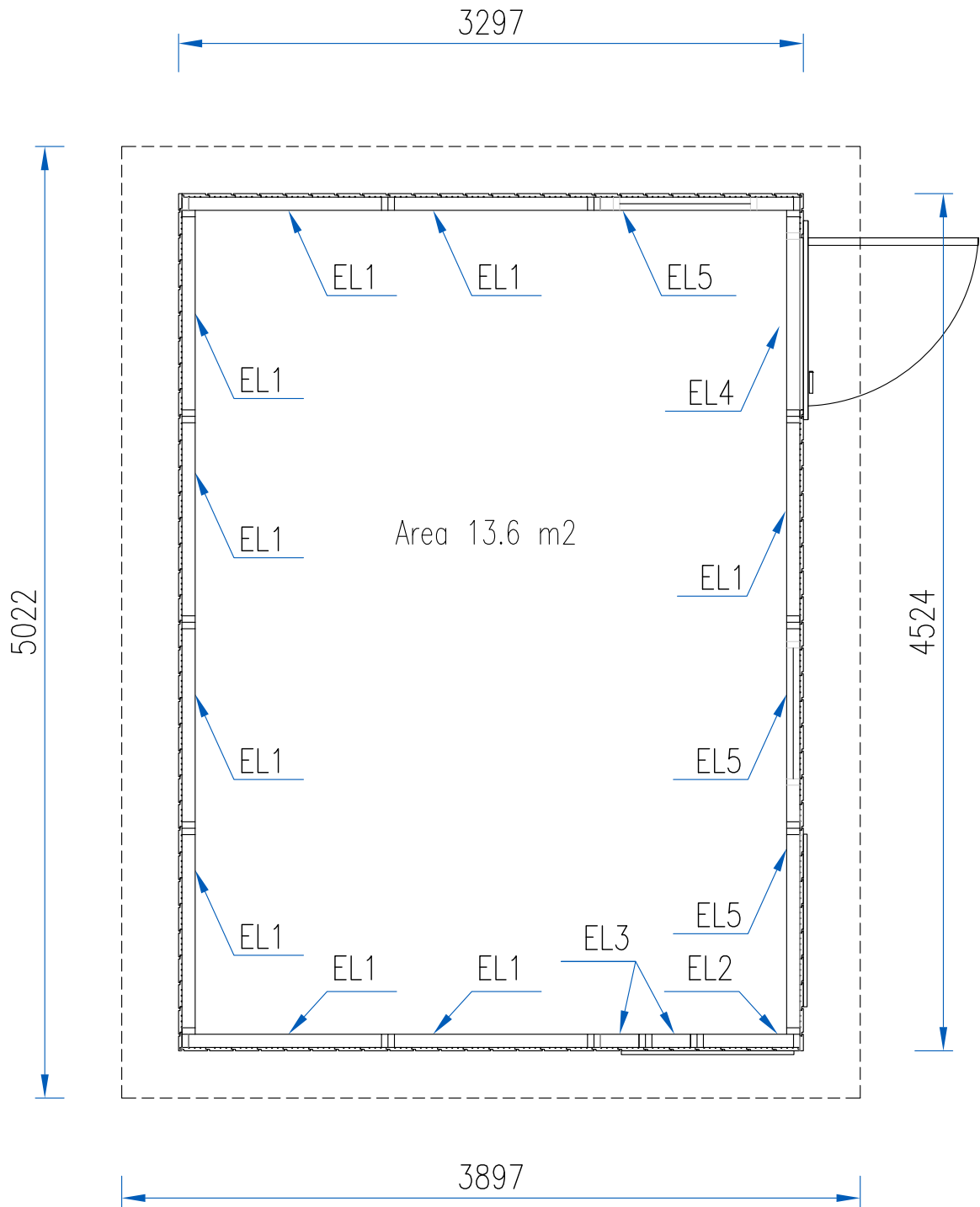

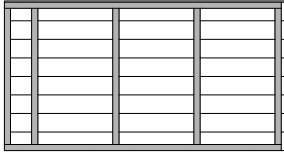
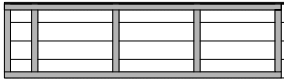

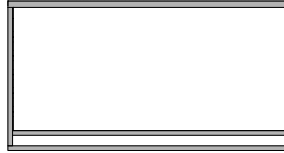
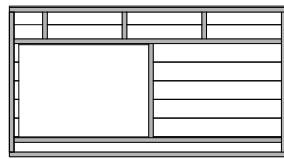
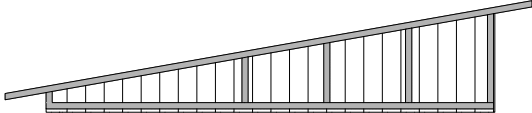
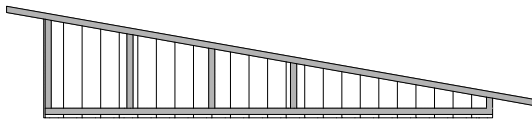
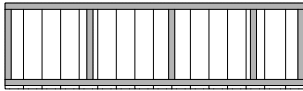

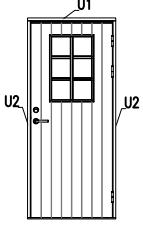
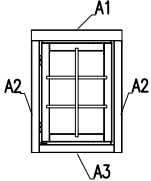















The producer shall have the right to make technical changes to the product • Technische Änderungen vorbehalten • Le
producteur réserve le droit d'effectuer des modifications techniques au produit • Il produttore mantiene il diritto di apportare
modifiche tecniche al prodotto • Reservado el derecho a modificaciones técnicas • Produsent forbeholder seg retten til å endre
tekniske egenskaper ved produktet • Alle rechten en technische wijzigingen voorbehouden • Valmistaja pidättää oikeuden tehdä
tuotteeseen teknisiä muutoksia • Tillverkaren har rätt att utföra tekniska förändringar för produkten



Ethel 13.6 m2
Plan

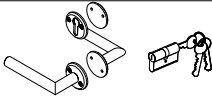

EL1		2055 x 1097 x 88	10
EL2		2055 x 553 x 88	1
EL3		2055 x 282 x 88	2
EL4		2055 x 1097 x 88	1
EL5		2055 x 1097 x 88	2
EL6		3849 x 751 x 88	1
EL7		3849 x 751 x 88	1
EL8		2202 x 567 x 88	1
EL9		2192 x 567 x 88	1
U105-11-920R	 <p>U1 - 19x45x950 2 pcs U2 - 19x95x1980 4 pcs</p>	870 x 1985 x 105	1
A105-7R	 <p>A1 - 19x70x830 2 pcs A2 - 19x70x1050 4 pcs A3 - 19x70x630 2 pcs</p>	660 x 1740 x 105	2

1	 Impregnated	45 x 145 x 4488	2
2	 Impregnated	45 x 145 x 3171	9
3		19 x 89 x 4488	37
4		34 x 70 x 4384	1
5		44 x 140 x 3910	7
6		10 x 165 x 576	12
7		10 x 165 x 450	4
8		16 x 120 x 2514	6
9		16 x 95 x 2514	2
10		16 x 45 x 2514	2
11		16 x 120 x 3957	4
12		16 x 95 x 3957	2
13		32 x 40 x 3890	2
14		19 x 89 x 4990	45
15		18 x 135 x 2055	4
16		18 x 135 x 545	2
F1		90 x 90 x 65	14
F2		Ø 6 x 120	36
F3		Ø 4.5 x 70	170
F4		Ø 4 x 50	330
F5		Ø 4 x 40	180
F6		Ø 3 x 70	700
F7		QULink/ASSA QULSydamik/ASSA QULSydamikkate/ASSA	1 set
F8		QVentRest100x150Zn	2
F9		Ø 2.5 x 16	8

3261

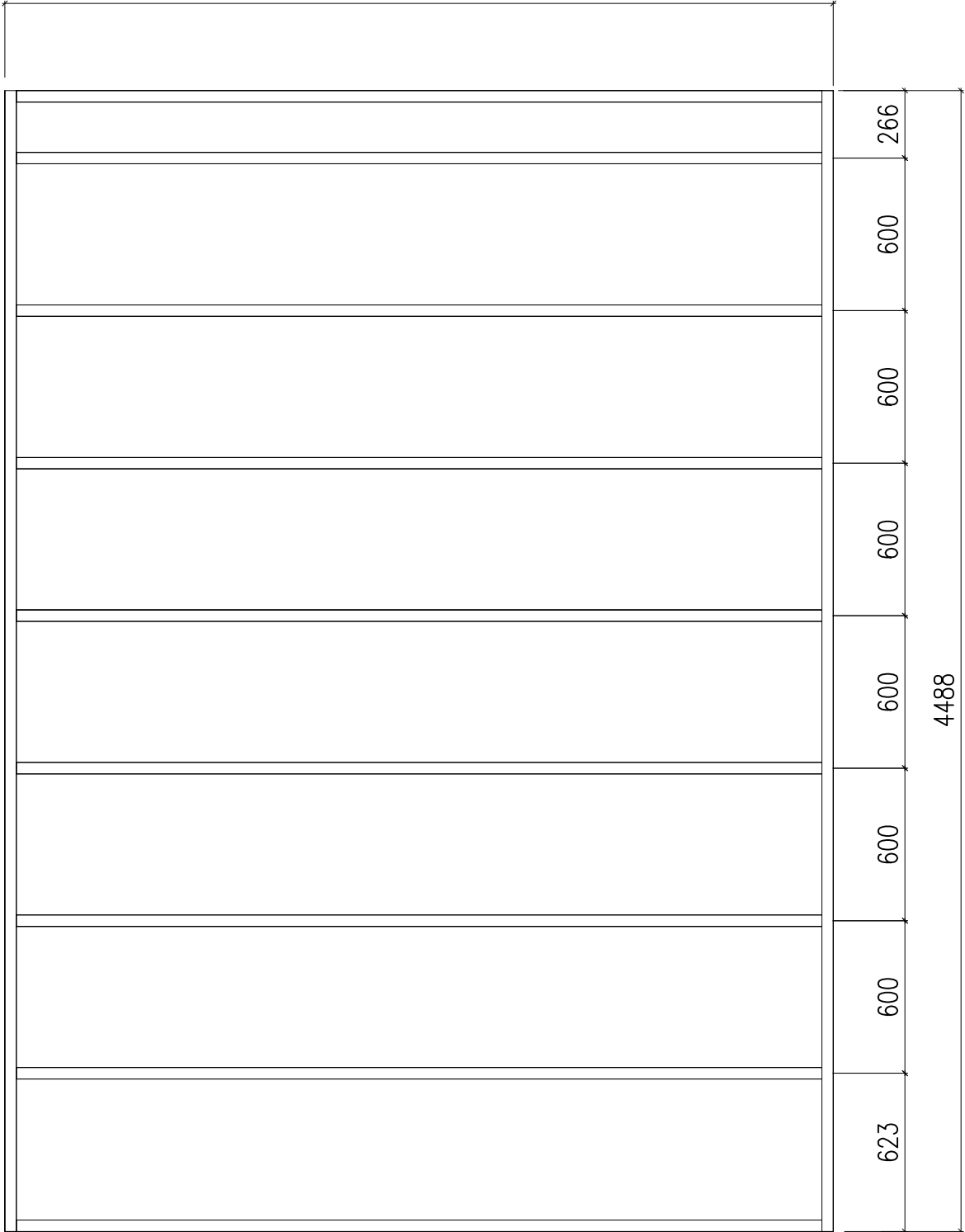

266

600

600

600

600

600

600

600

623

4488

1

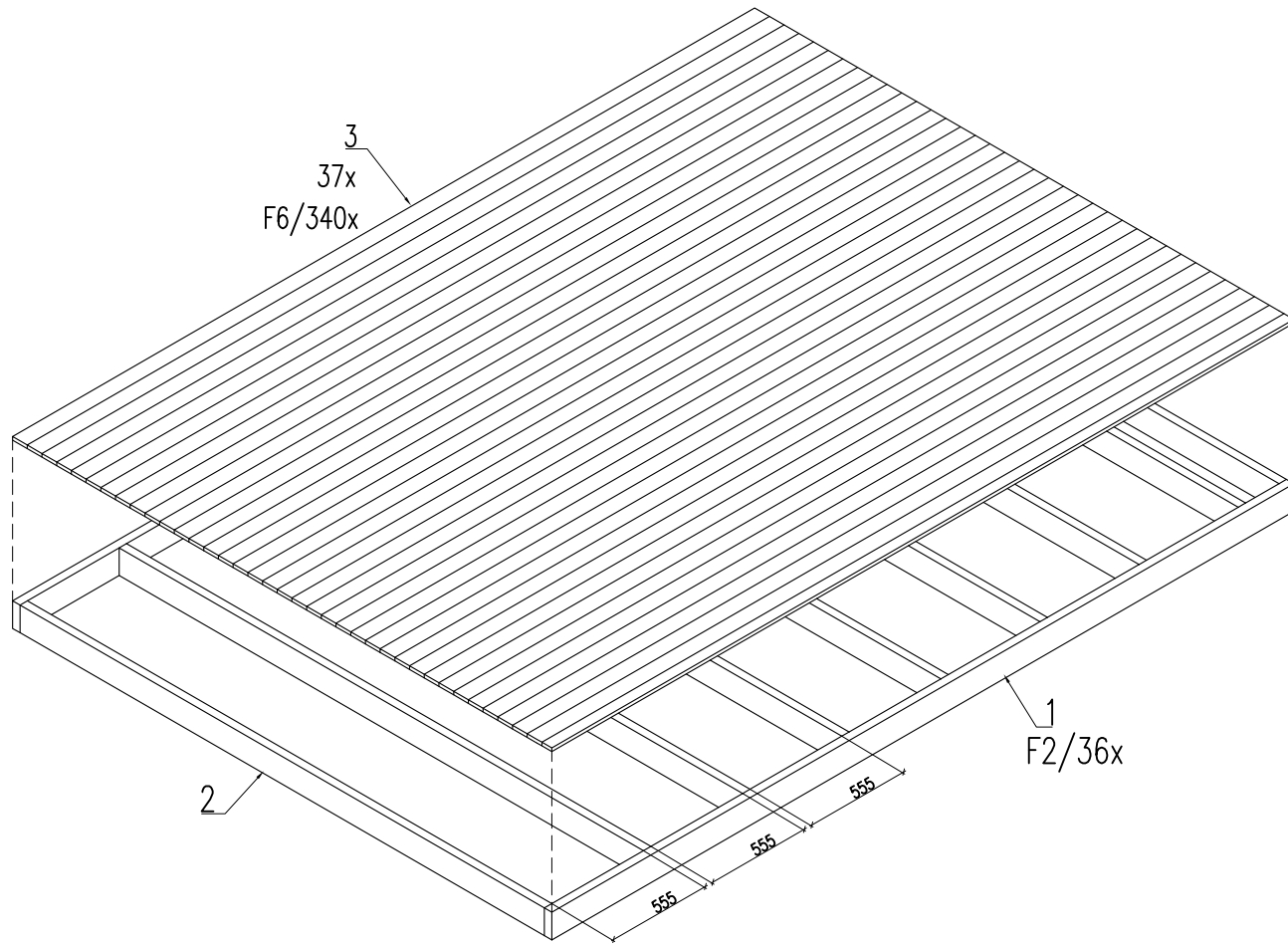

2

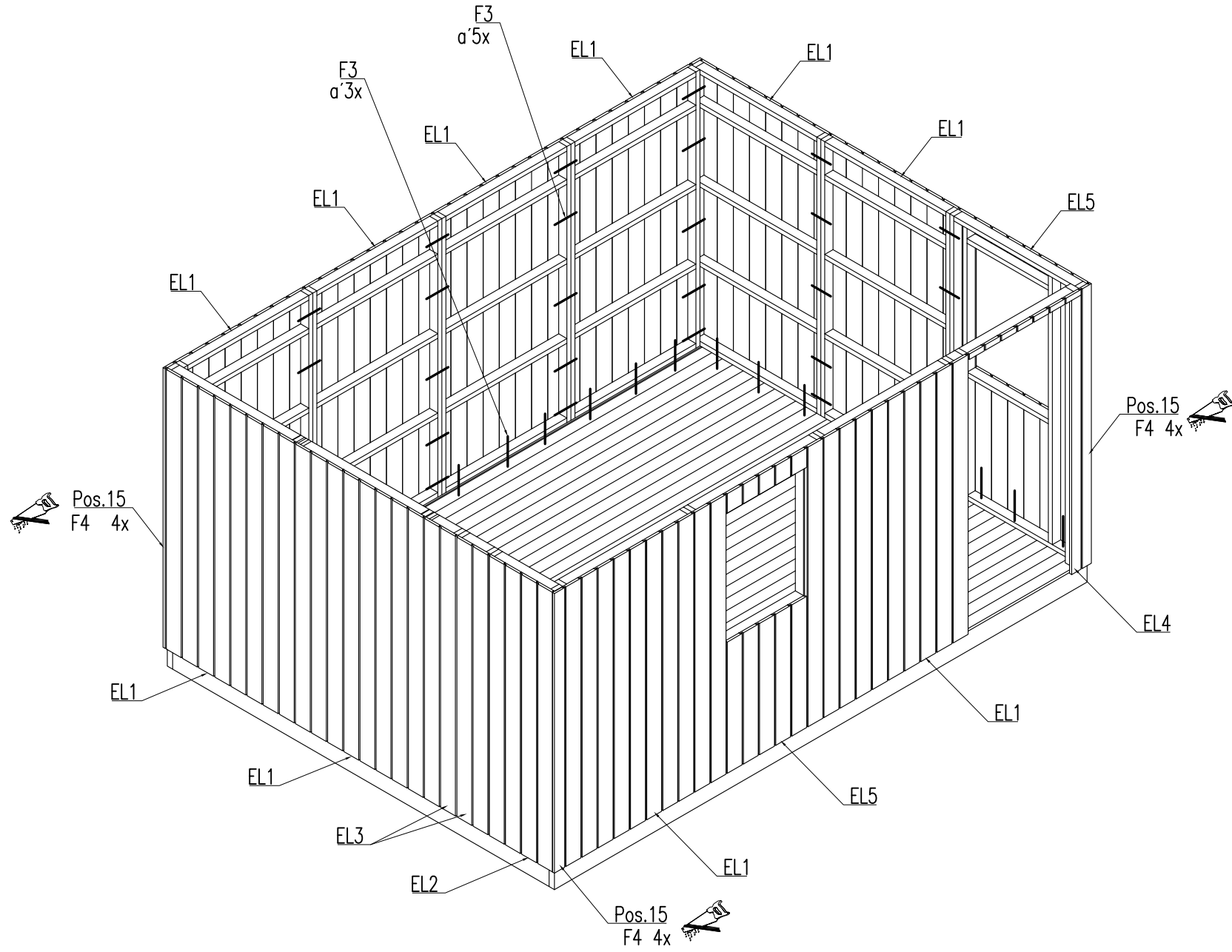

3

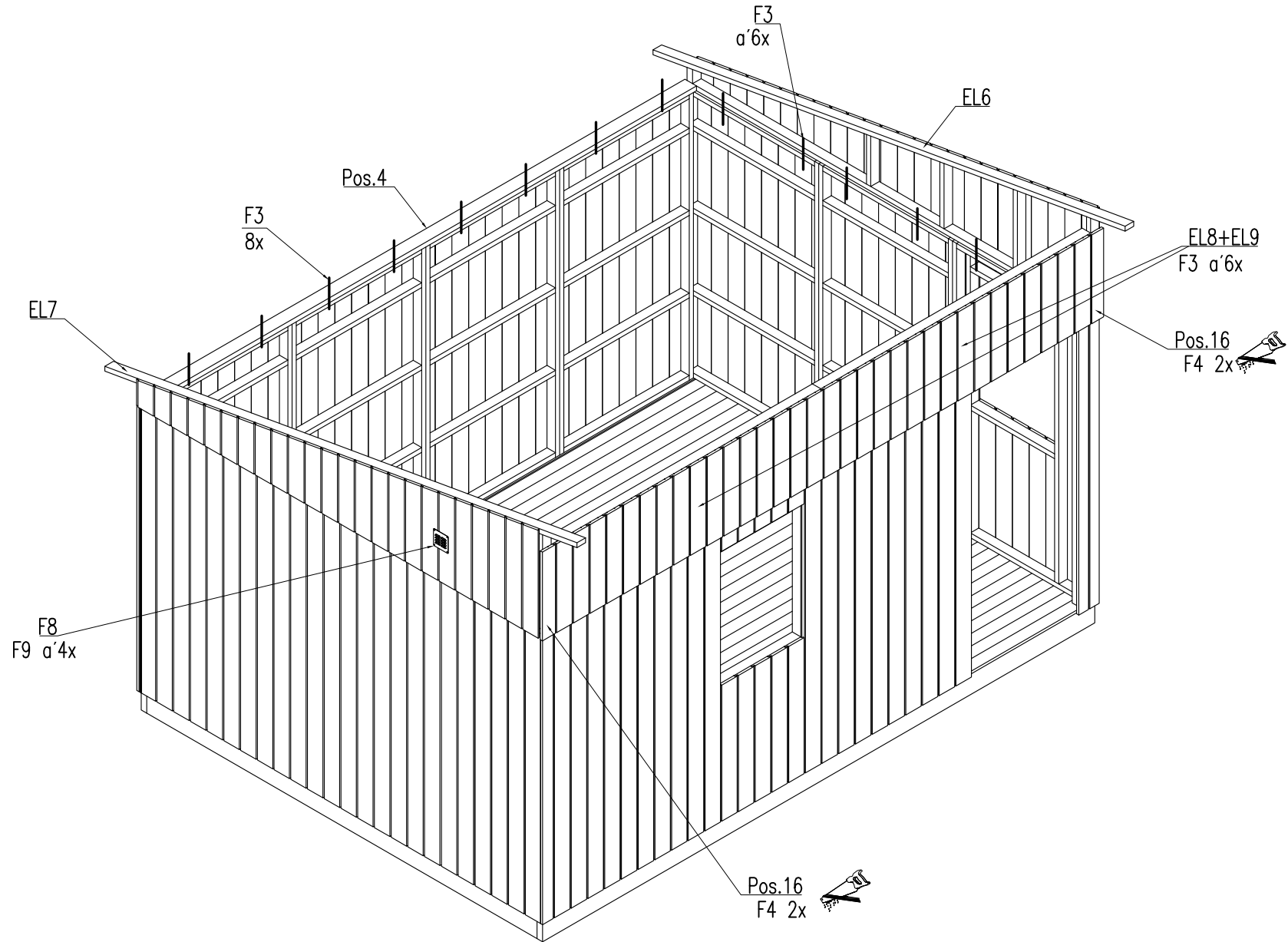

4

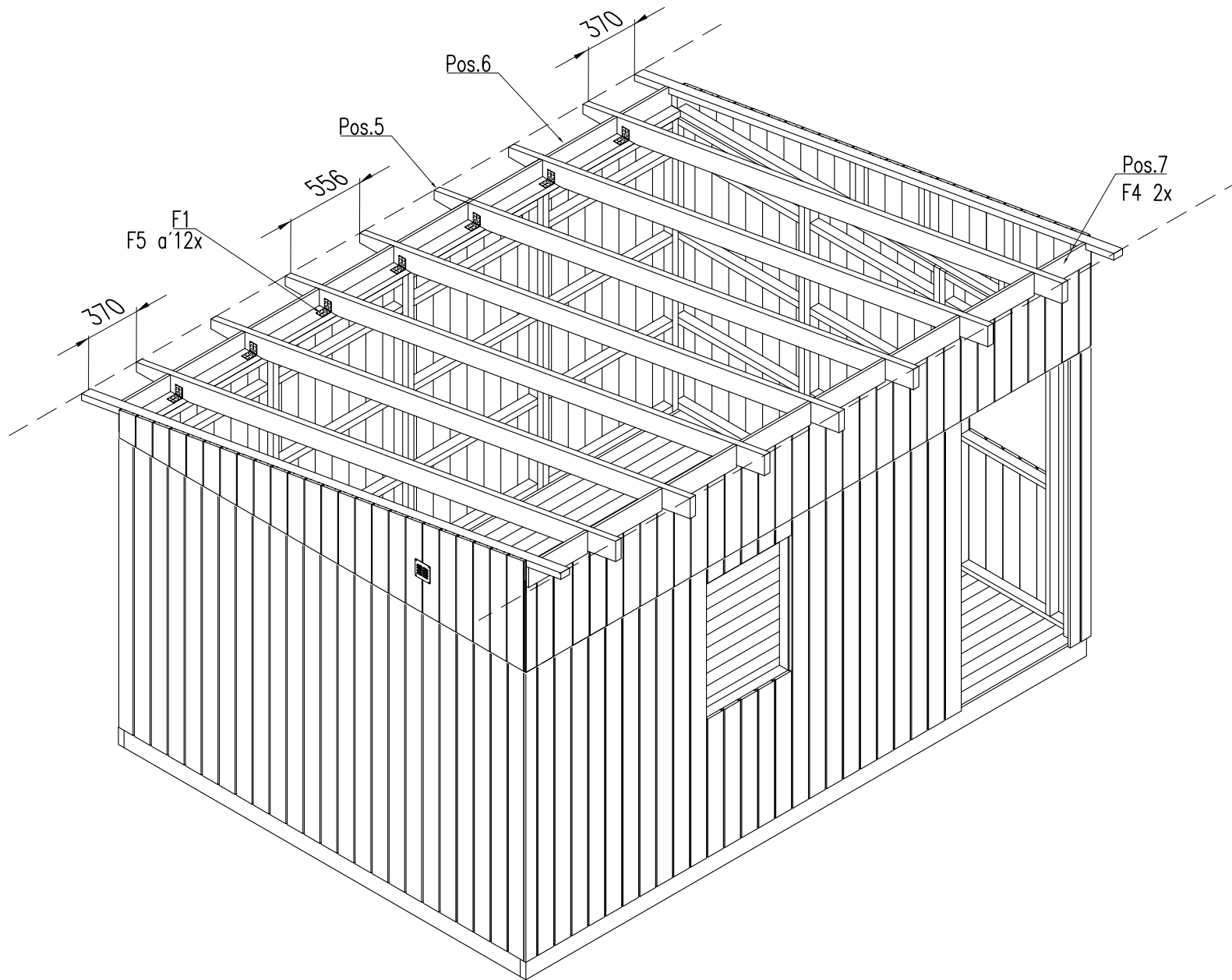

5

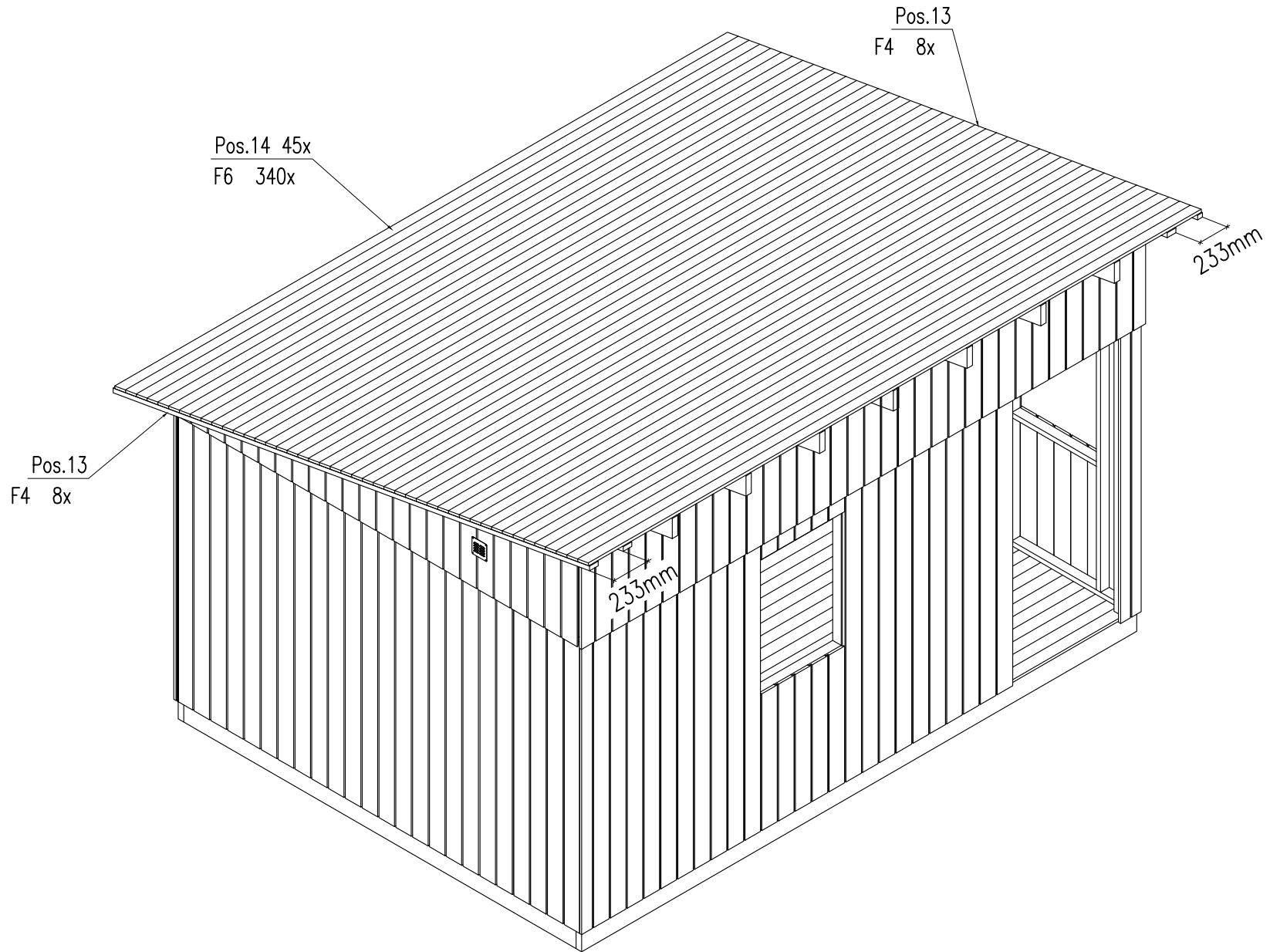

6

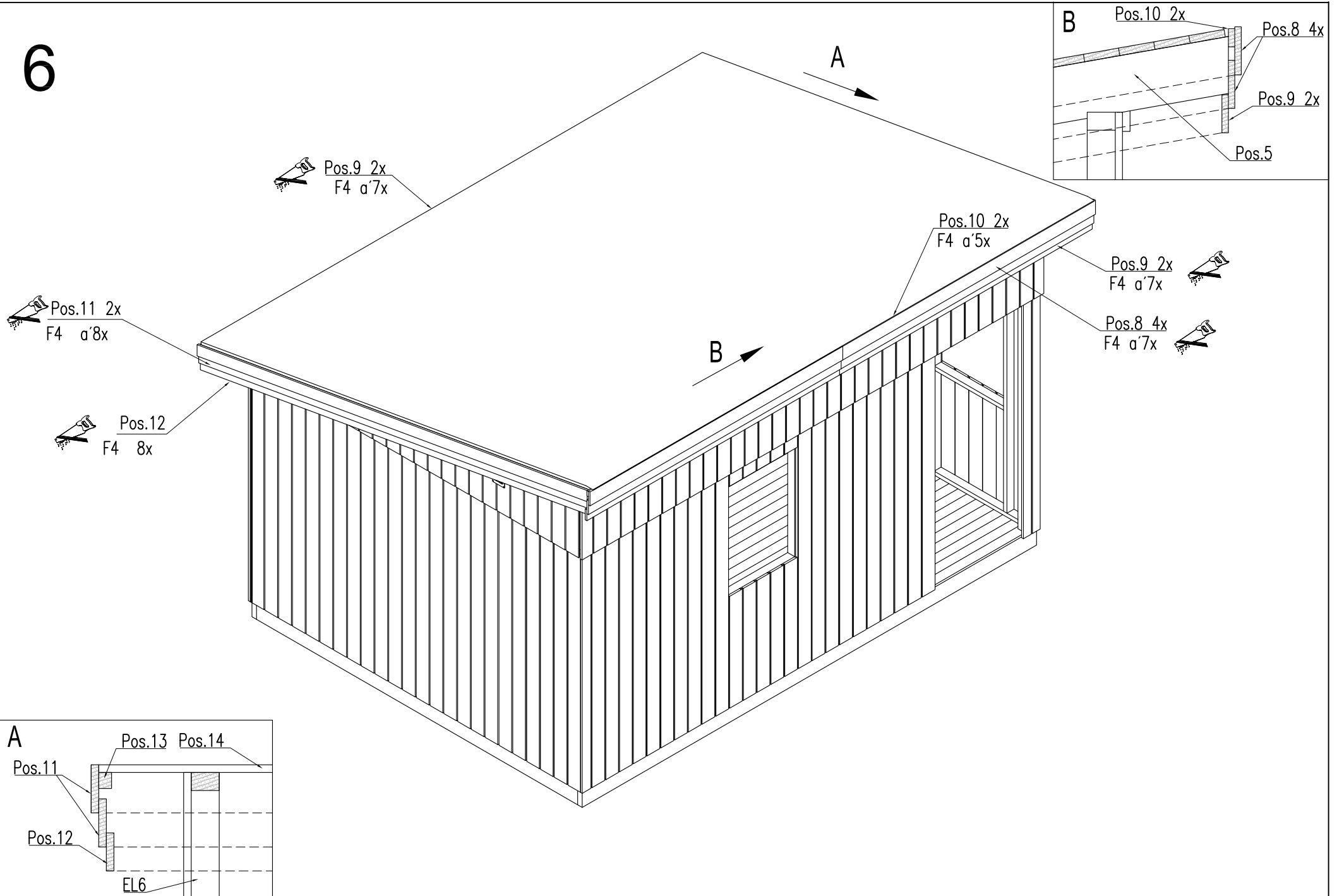

7

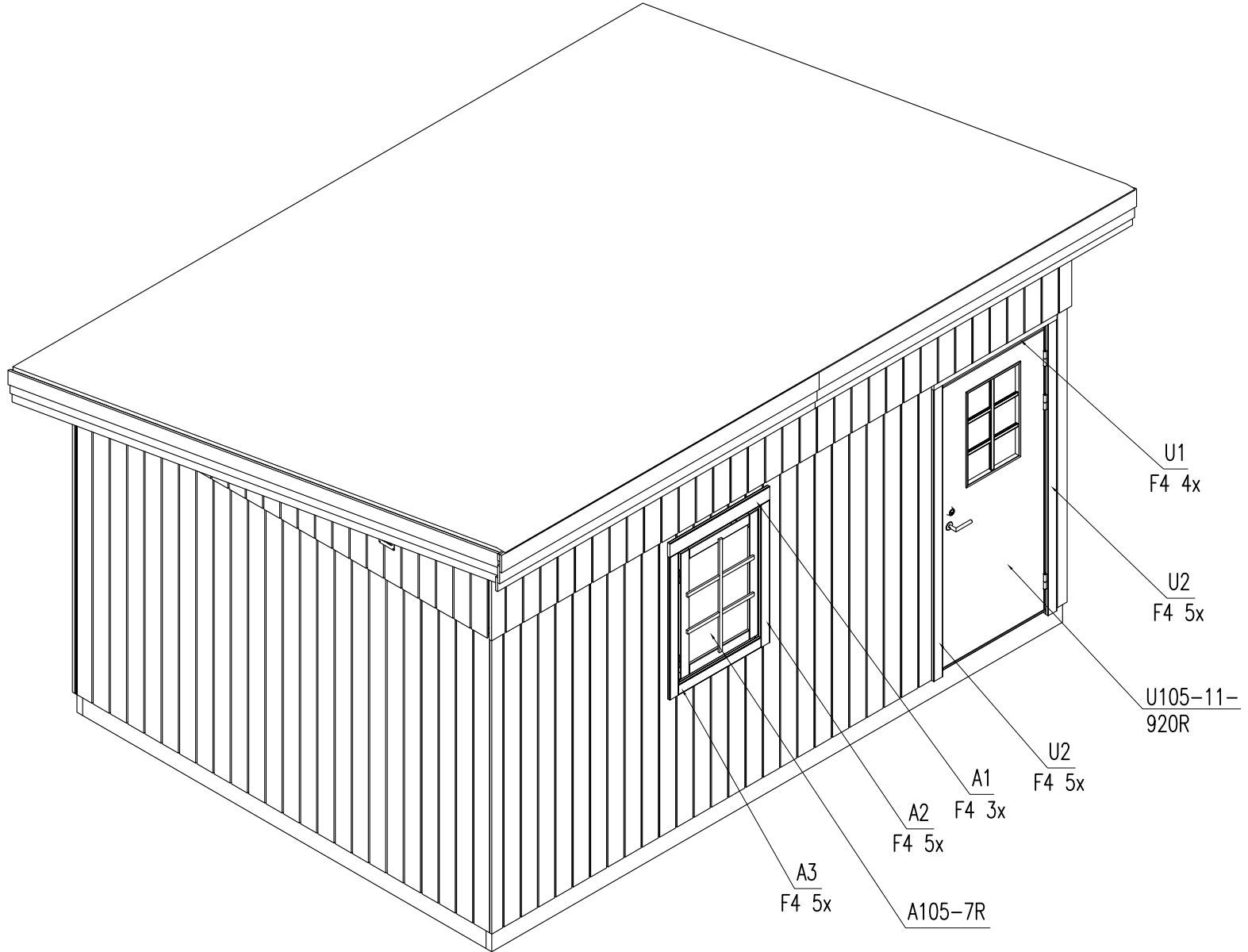

8

