

Installation manual

Montageanleitung • Notice de montage • Istruzioni per il montaggio • Manual de montaje • Monteringsanvisning •
Installatiegids • Montážní návod • Asennusohje • Installationsmanual

Log cabin FRR44-5332-1

Blockhaus • Maisonnette en poutres • Casa di travi • Casa de jardin • Anneks • Tuinhuis • Zahradní domek •
Timmerstuga • Hirsimökki

Width 530 x Depth 320 cm







Breite/Tiefe • Largeur/Profondeur • Lunghezza/Profondità • Ancho/Profundidad • Bredde/Dybde • Breedte/Diepte
• Šířka/Hloubka • Leveys/Pituus • Bredd/Längd

Log thickness 44 mm

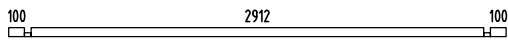
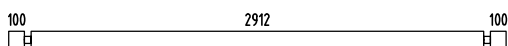
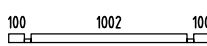
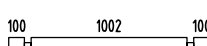
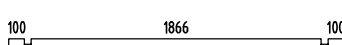
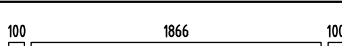
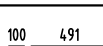

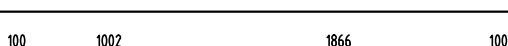

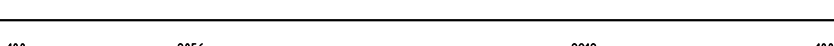
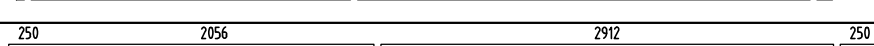
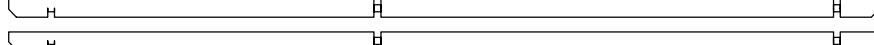

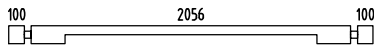
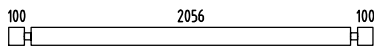
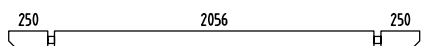
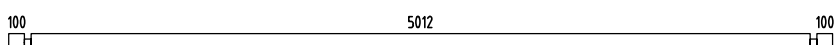
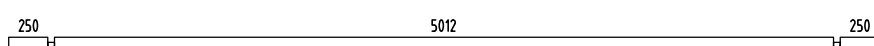
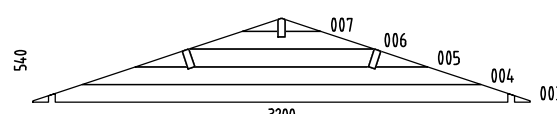
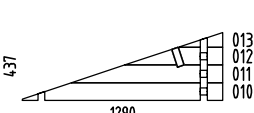
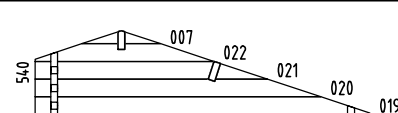

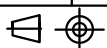







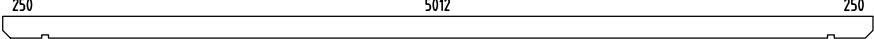
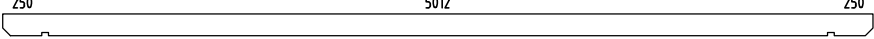
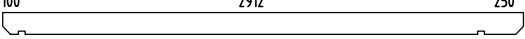

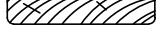

Bohlenstärke • Épaisseur des murs • Spessore delle pareti • Grosor de pared • Tykkelse • Wanddike • Tloušťka
stěny • Seinän paksuus • Väggtjocklek











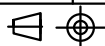



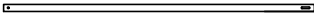

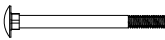
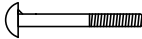
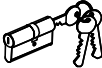













The producer shall have the right to make technical changes to the product • Technische Änderungen vorbehalten • Le
producteur réserve le droit d'effectuer des modifications techniques au produit • Il produttore mantiene il diritto di apportare
modifiche tecniche al prodotto • Reservado el derecho a modificaciones técnicas • Produsent forbeholder seg retten til å endre
tekniske egenskaper ved produktet • Alle rechten en technische wijzigingen voorbehouden • Výrobce si vyhrazuje právo na
technické změny výrobku • Valmistaja pidättää oikeuden tehdä tuotteeseen teknisiä muutoksia • Tillverkaren har rätt att utföra
tekniska förändringar för produkten

Pos	SPECIFICATION-STÜCKLISTE-NOMENCLATURE-ELEMENTI-ESPECIFICACIÓN "FRR44-5332-1"	Pcs	Profile (mm)	Length (mm)
001		1	44x57	3200
002		24	44x114	3200
008		1	44x57	1290
009		17	44x114	1290
014		1	44x57	2154
015		7	44x114	2154
016		18	44x114	635
017		1	44x57	190
018		1	44x114	3200
023		18	44x114	475
024		9	44x114	475
025		1	44x114	5300
026a		1	44x114	5600
026b		1	44x114	5600
027		34	44x114	362
028		1	44x114	2344
029		2	44x114	2344
030		1	44x114	2644
031		17	44x114	5300
032		1	44x114	5600
W1-1		1		
W2-1		1		
W3-1		1		



Pos	SPECIFICATION-STÜCKLISTE-NOMENCLATURE-ELEMENTI-ESPECIFICACIÓN "FRR44-5332-1"	Pcs	Profile (mm)	Length (mm)
AR1	Foundation- Fundament- Fondazione- Vigas de cimentación 	2	60x80	5090
AR3	Foundation- Fundament- Fondazione- Vigas de cimentación 	10	60x80	2870
AR2	Foundation- Fundament- Fondazione- Vigas de cimentación 	3	60x80	626
Pst1	Post- Pfosten- Poteau- Montante- Poste 	1	90x90	1940
Rai3	Railing board- Geländer- Barre de rambarde- Tavola di ringhiera- Tabla de barandilla 	2	70x19	1046
Rai1	Railing board- Geländer- Barre de rambarde- Tavola di ringhiera- Tabla de barandilla 	6	70x19	800
Rai2	Railing board- Geländer- Barre de rambarde- Tavola di ringhiera- Tabla de barandilla 	1	19x70	856
PR3	Purlin- Dachpfette- Arbaletrier- Arcareccio- Vigueta de tejado 	1	44x140	5600
PR2	Purlin- Dachpfette- Arbaletrier- Arcareccio- Vigueta de tejado 	1	44x140	5600
PR1	Purlin- Dachpfette- Arbaletrier- Arcareccio- Vigueta de tejado 	1	44x140	3350
FB2-1	Floor board- Fussbodenbrett- Madrier du plancher - Tavola pavimento- Tabla de suelo 	21	89x19	5005
FB2-2	Floor board- Fussbodenbrett- Madrier du plancher - Tavola pavimento- Tabla de suelo 	12	89x19	2905
TB1-1	Terrace board- Terrassenbrett- Madrier de terrace- Tavola terrazzo- Tabla de terraza 	6	95x19	2098
TB1-2	Terrace board- Terrassenbrett- Madrier de terrace- Tavola terrazzo- Tabla de terraza 	5	95x19	2097
RB2-1	Roof board- Dachbrett- Madrier du toit- Tavola tetto- Tabla de tejado 	126	89x19	1900
Dia-1	Diamond- Deckbrett- Madrier- Tavola di copertura- Rombo 	2	19x140	300
EaE1-1	Eave edging- Dachrandbrett- Madrier en bordure du toit- Tavola bordo tetto- Tabla de valadizo 	4	16x95	2800
FaB3-1	Facia board- Giebelblende- Écran frontal- Schermo frontone- Tabla de facia 	4	16x120	1940
FIB3-1	Floor beading- Fussbodenleiste- Baguette du plancher- Listello pavimento- Listón de suelo 19x45 	6	19x45	2912
RE2-1	Roof edge reinforcement- Dachrandleiste- Baguette en bordure du toit- Rinforzo bordo tetto- Refuerzo borde tejado 	2	32x40	2650
RE2-2	Roof edge reinforcement- Dachrandleiste- Baguette en bordure du toit- Rinforzo bordo tetto- Refuerzo borde tejado 	2	32x40	2950
Sis1-1	Side slat- Randleiste- Baguette en bordure- Listón de borde- Listello bordo 	6	19x70	846
Sis1-2	Side slat- Randleiste- Baguette en bordure- Listón de borde- Listello bordo 	12	19x70	1018
Sis2-1	Side slat- Randleiste- Baguette en bordure- Listón de borde- Listello bordo 	6	19x95	986



Pos	SPECIFICATION-STÜCKLISTE-NOMENCLATURE-ELEMENTI-ESPECIFICACIÓN "FRR44-5332-1"	Pcs	Profile (mm)	Length (mm)
Sl10-1	Slat- Leiste- Baguette- Listello- Listón 	1	19x45	1620
StB1-1	Storm brace- Sturmleiste- Protection contre le vent- Antivento- Protector contra tormentas 	4	25x45	2000
Fim	-Fixing kit- Befestigungsset- Moyens de fixation- Materiale di fissaggio- Kit de fijación 	1	<u>USE</u>	
QLP16	Adjustment bolt - Senkbolzen - Boulon de réglage - Bullone di regolamento- Perno de ajuste 	1	Pst1	
QPUPO 8x100	Bolt -Schloss-schraube -Boulon- Bullone- Perno- M8x100mm PUP0 	2	Pst1	
QPUP 08x80	Bolt -Schloss-schraube -Boulon- Bullone- Perno- M8x80mm PUP0 	8	StB1-1	
QULSy damik 30/35	Cylinder- Zylinderschloss- Serrure a mortaiser- Serratura a cilindro- Bombin- 30.35 	1	TU44-10R	
QULKat eHOBEk	Door fittings- Türbeschlag- Ferrure- Ferramenta porta- Manilla puerta- QULKateHOBEk 	1	TU44-10R	
QULli nkHOBE	Door fittings- Türbeschlag- Ferrure- Ferramenta porta- Manilla puerta- QULlinkHOBE 	1	TU44-10R	
QServa riiviv astus160	Keeper- Schliessblech- Toile- Lamiera- Aldaba de candado- 160 	1	TU44-10R	
QNU35 35130	L-iron- Winkel- Angle -Angolo- Angulo 35x35x130 EM VN353590 	2	Rai3	
QNU4 04040	L-iron- Winkel- Angle -Angolo- Angulo 40x40x40 	6	Rai3	
QNA1 4x40M	Nail- Nagel- Clou- Chiodo- Clavo- 1.4x40mm 	40	FIB3-1	
QNA2 2x50Zn	Nail- Nagel- Clou- Chiodo- Clavo- 2.5x50mm 	700	FB2-1 RB2-1	
QMU8	Nut- Schraubenmutter- Écrou- Dado- Tuerca- M8mm 	10	StB1-1 Pst1	
QKR3 5x35ZN	Screw- Schraube- Vis- Vite- Tornillo- 3.5x35mm 	12	Rai1+Rai3	
QKR3x 16kZN	Screw- Schraube- Vis- Vite- Tornillo- 3x16mm kZn 	2		
QKR3 x20ZN	Screw- Schraube- Vis- Vite- Tornillo- 3x20mm 	30	TU44-10R A44-78R A44-78L	
QKR4 5x40ZN	Screw- Schraube- Vis- Vite- Tornillo- 4.5x40mm 	140	 EaE1-1; FaB3-1	
QKR4 5x50ZN	Screw- Schraube- Vis- Vite- Tornillo- 4.5x50mm 	100	SiSx	
QKR4 5x70ZN	Screw- Schraube- Vis- Vite- Tornillo- 4.5x70mm 	35	 001;008;014 026;030;032	
QKR4 x16ZN	Screw- Schraube- Vis- Vite- Tornillo- 4x16mm 	10		
QKR5 x90ZN	Screw- Schraube- Vis- Vite- Tornillo- 5x90mm 	16	PRx ; TU44-10R	
QKR6x 120ZN	Screw- Schraube- Vis- Vite- Tornillo- 6x120mm 	20	ARx	
QSE8x22	Washer- Dichtscheibe- Joint- Rondella- Arandela- 8x22mm 	10		

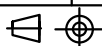

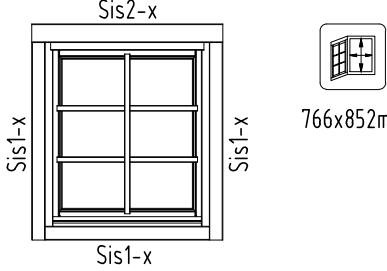
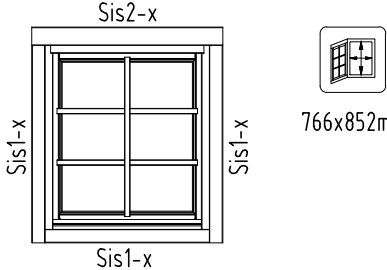
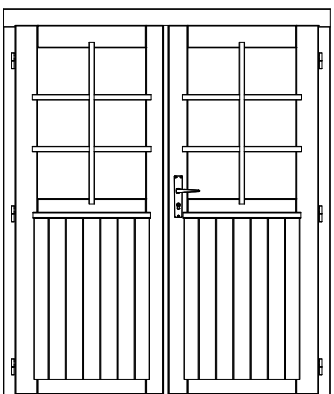
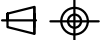
Pos	SPECIFICATION-STÜCKLISTE-NOMENCLATURE-ELEMENTI-ESPECIFICACIÓN "FRR44-5332-1"	Pcs	Profile (mm)	Length (mm)
QALLi nkHOBE	Window fittings- Fenstergriff- Poigne de la fenêtre- Maniglia finestra- Manilla (ventana)	3	A44-78	
A44-78L	<p style="text-align: center;">Window - Fenster - Fenetre - Finestra-Ventana 882x990</p>  <p style="text-align: center;">766x852mm</p>	2		
A44-78R	<p style="text-align: center;">Window - Fenster - Fenetre - Finestra-Ventana 882x990</p>  <p style="text-align: center;">766x852mm</p>	1		
TU44-10R	<p style="text-align: center;">Door - Tür - Porte - Porta-Puerta 1610x1936</p>  <p style="text-align: center;">1510x1867mm</p>	1		
	Object name "FRR44-5332-1"		Page 4/4	

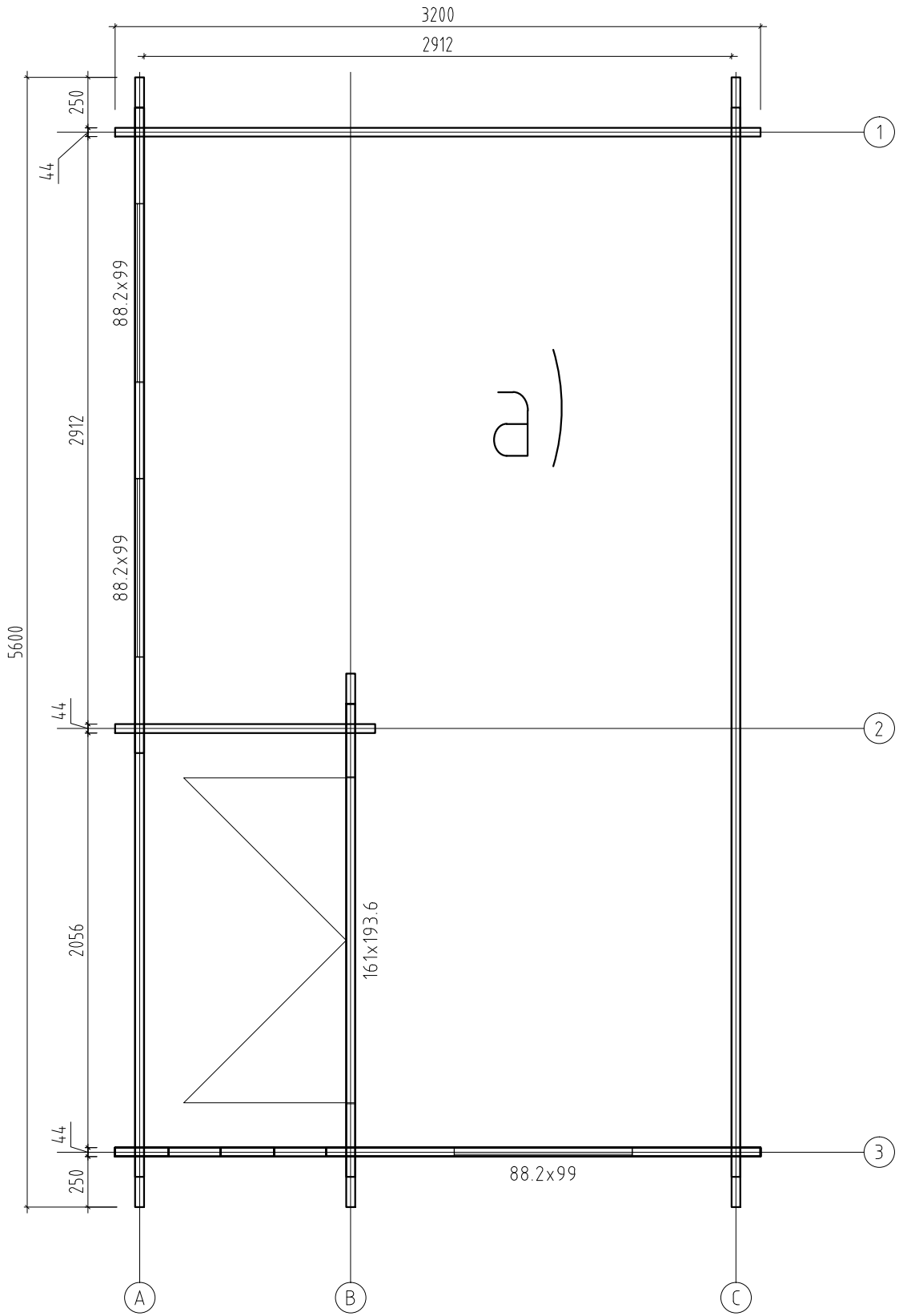

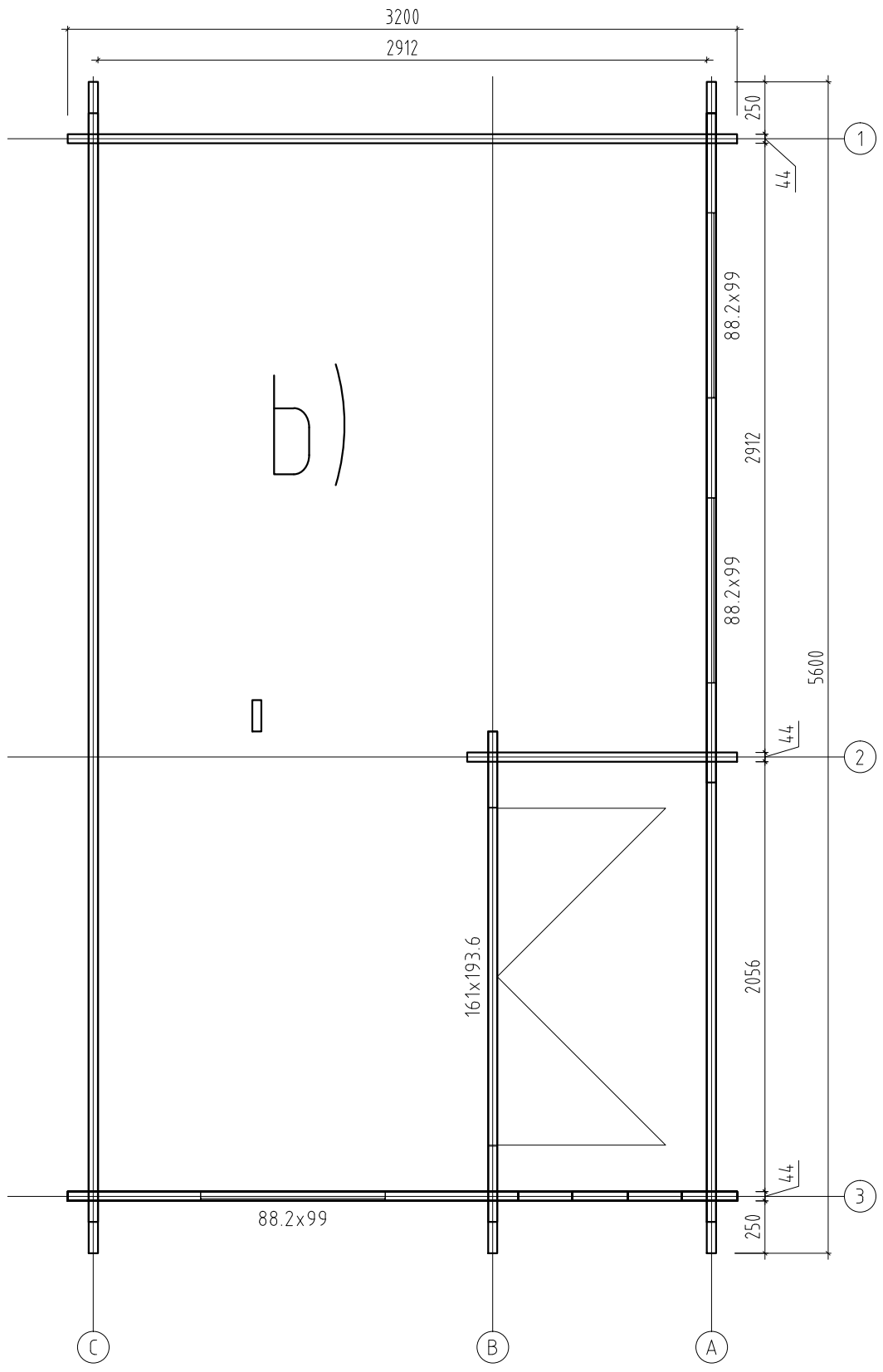

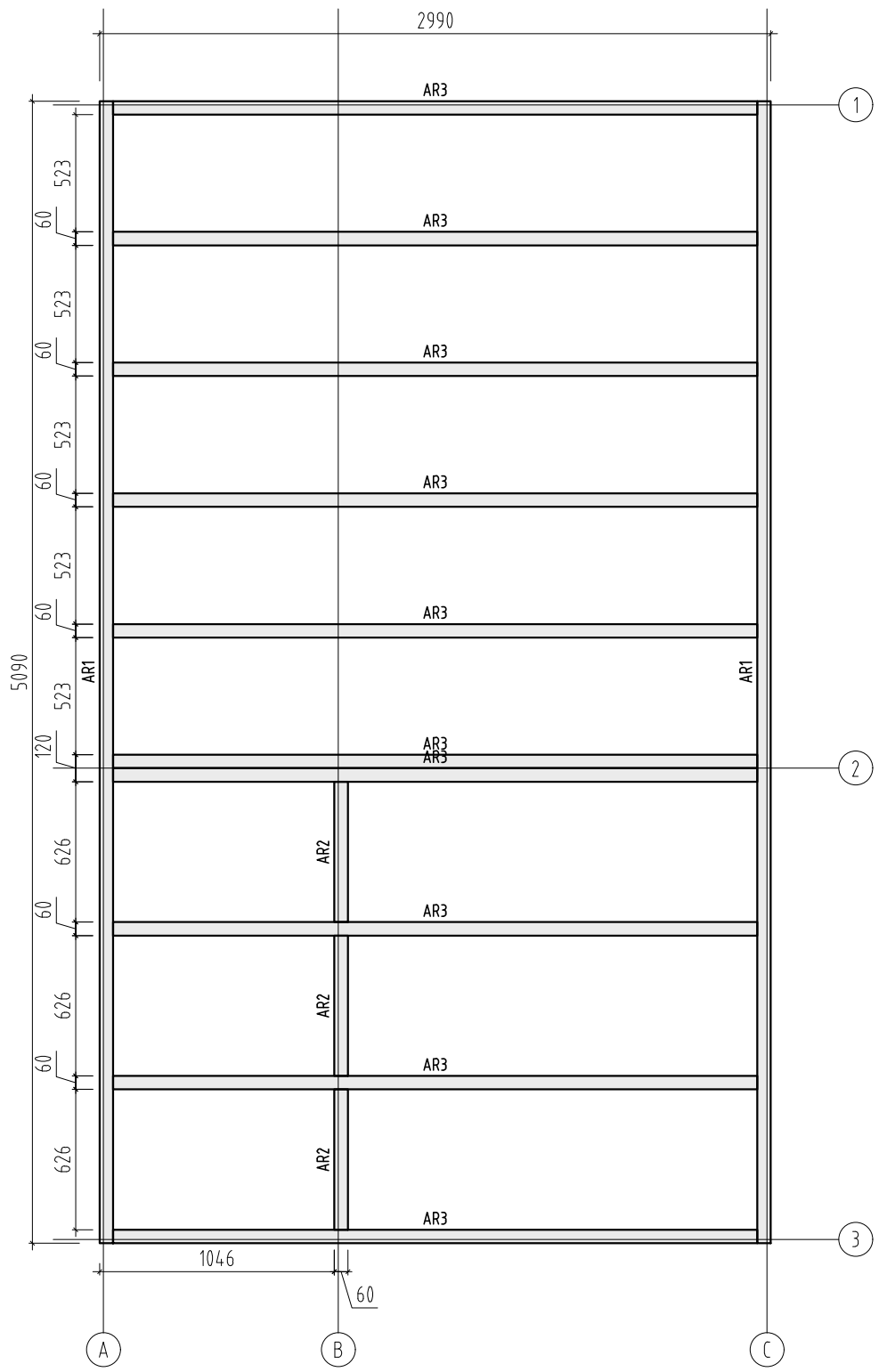

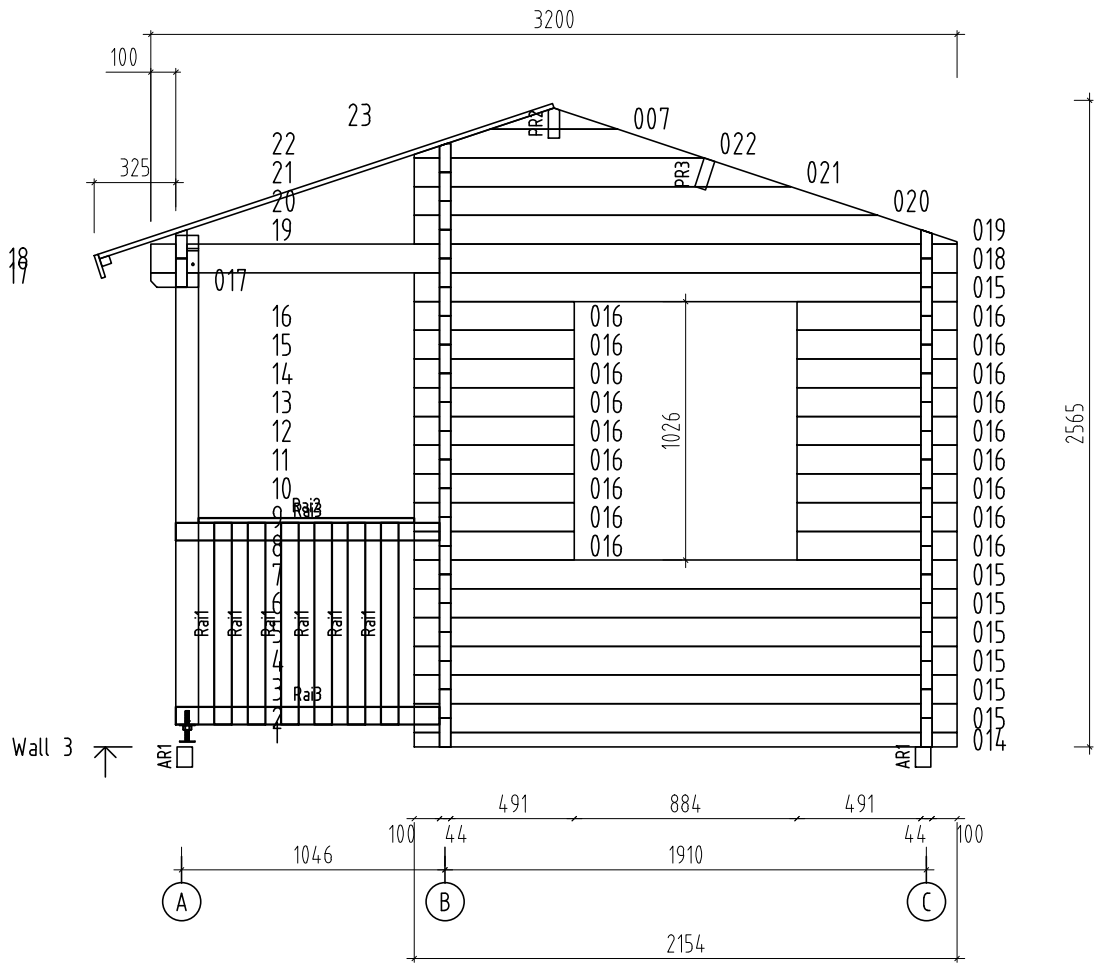

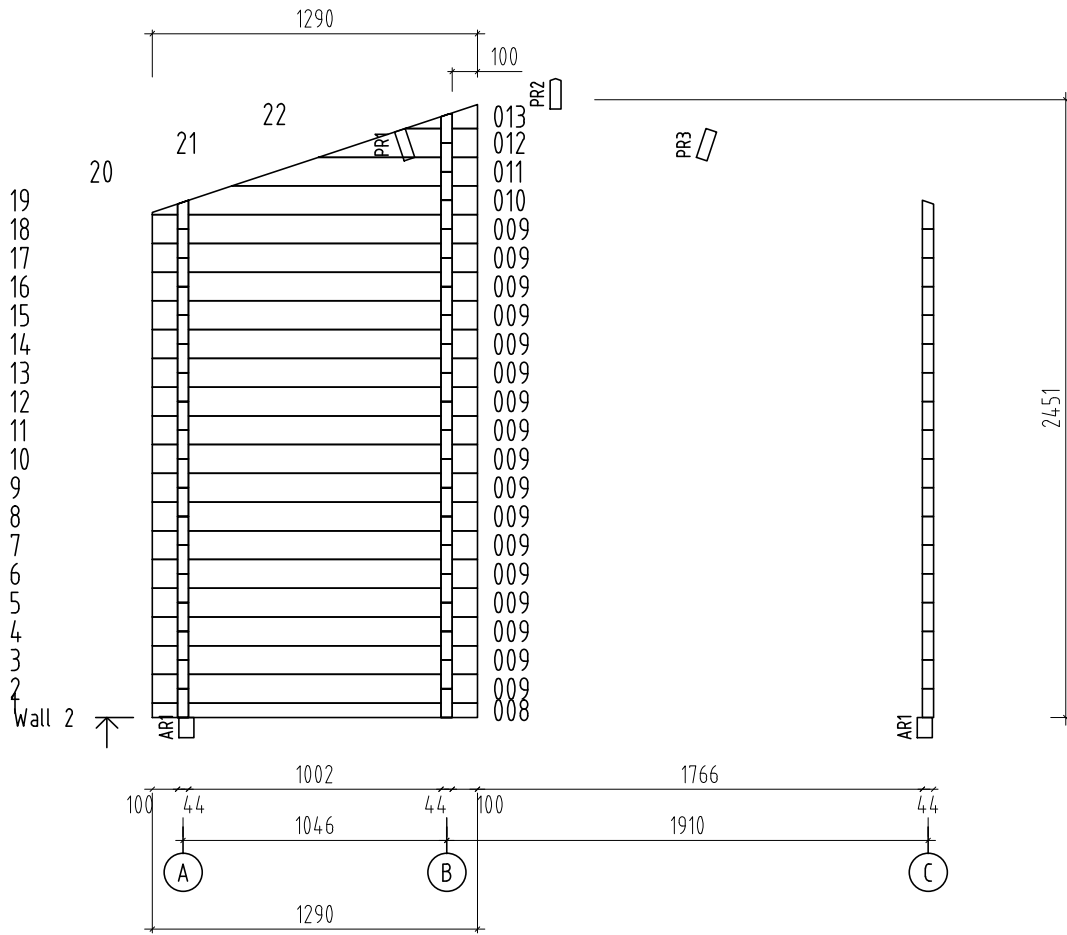

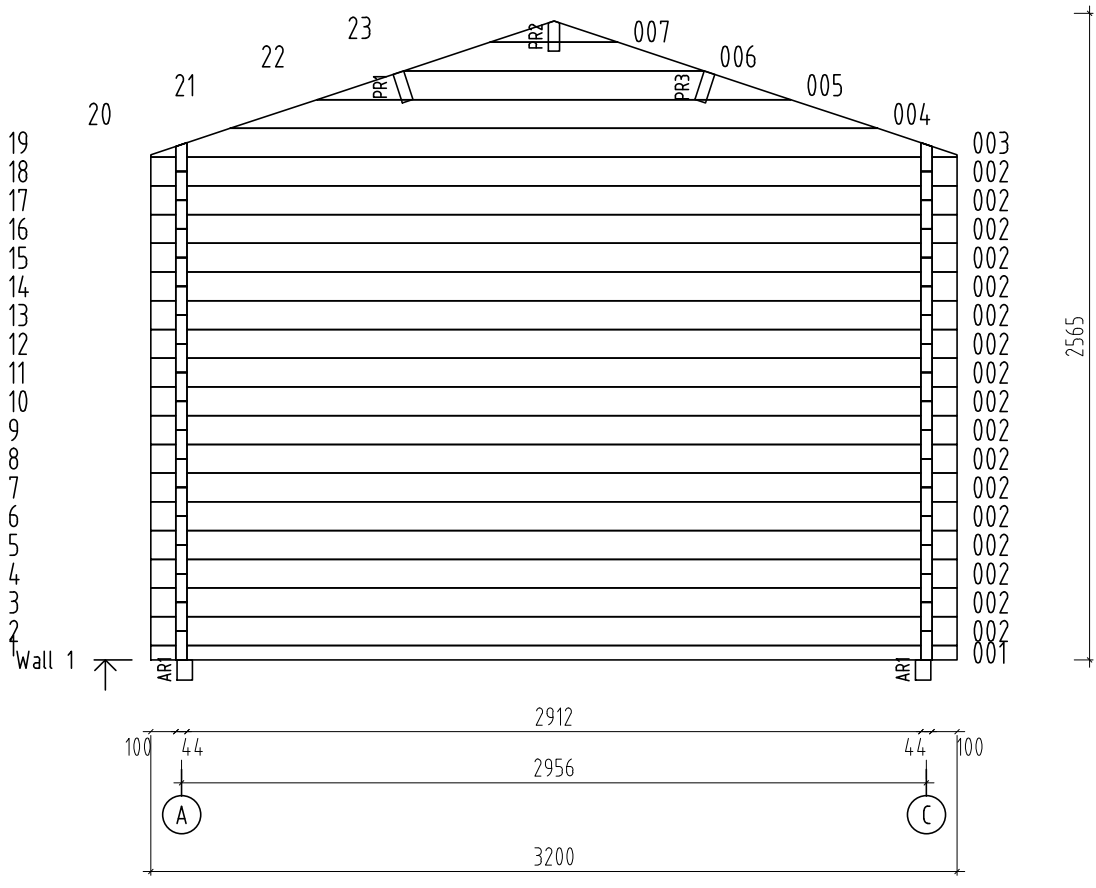

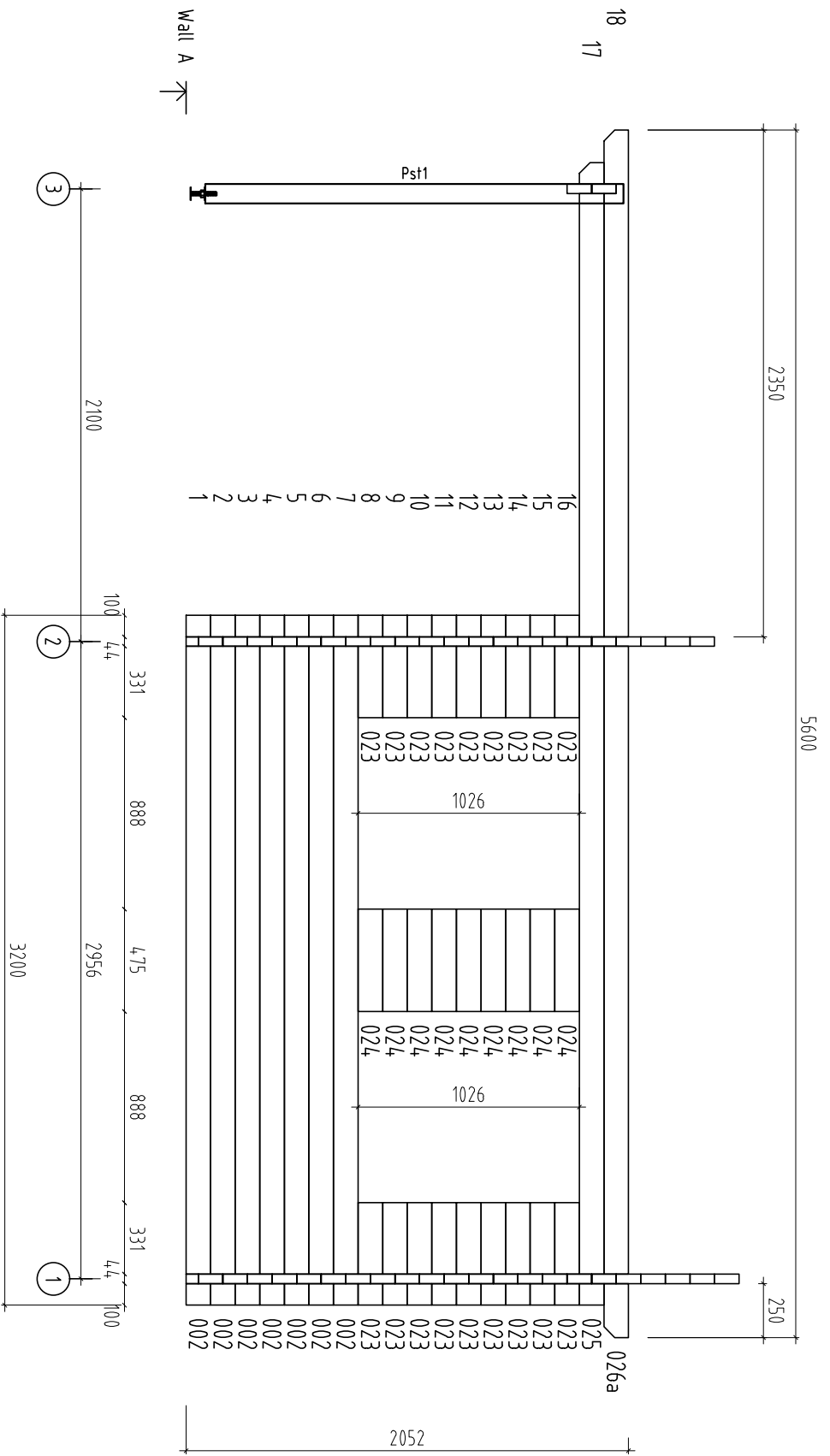

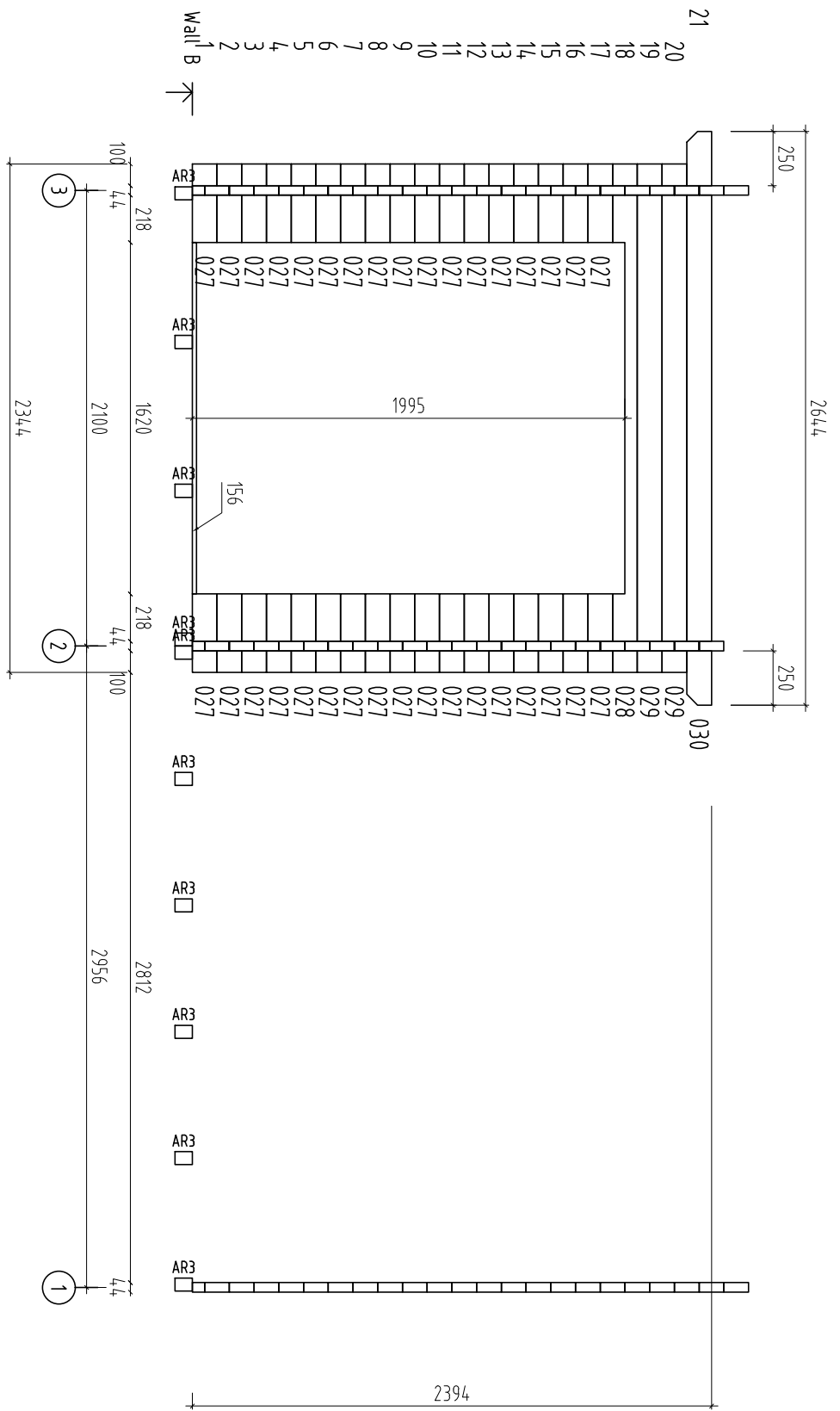

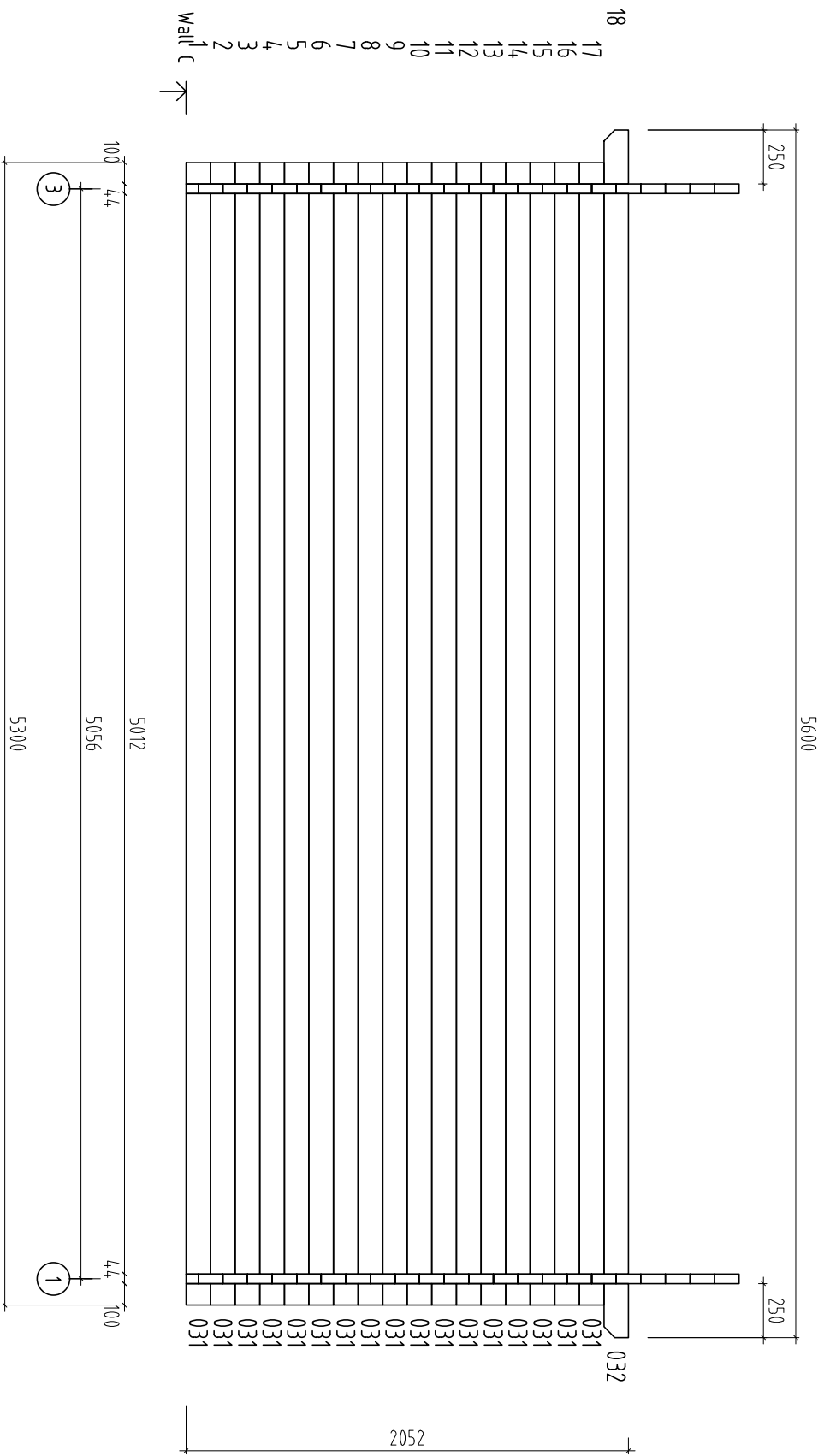

28x4.5
*

4.5x70

5x90

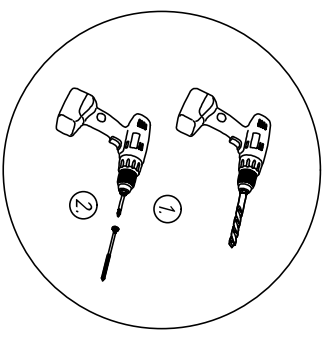
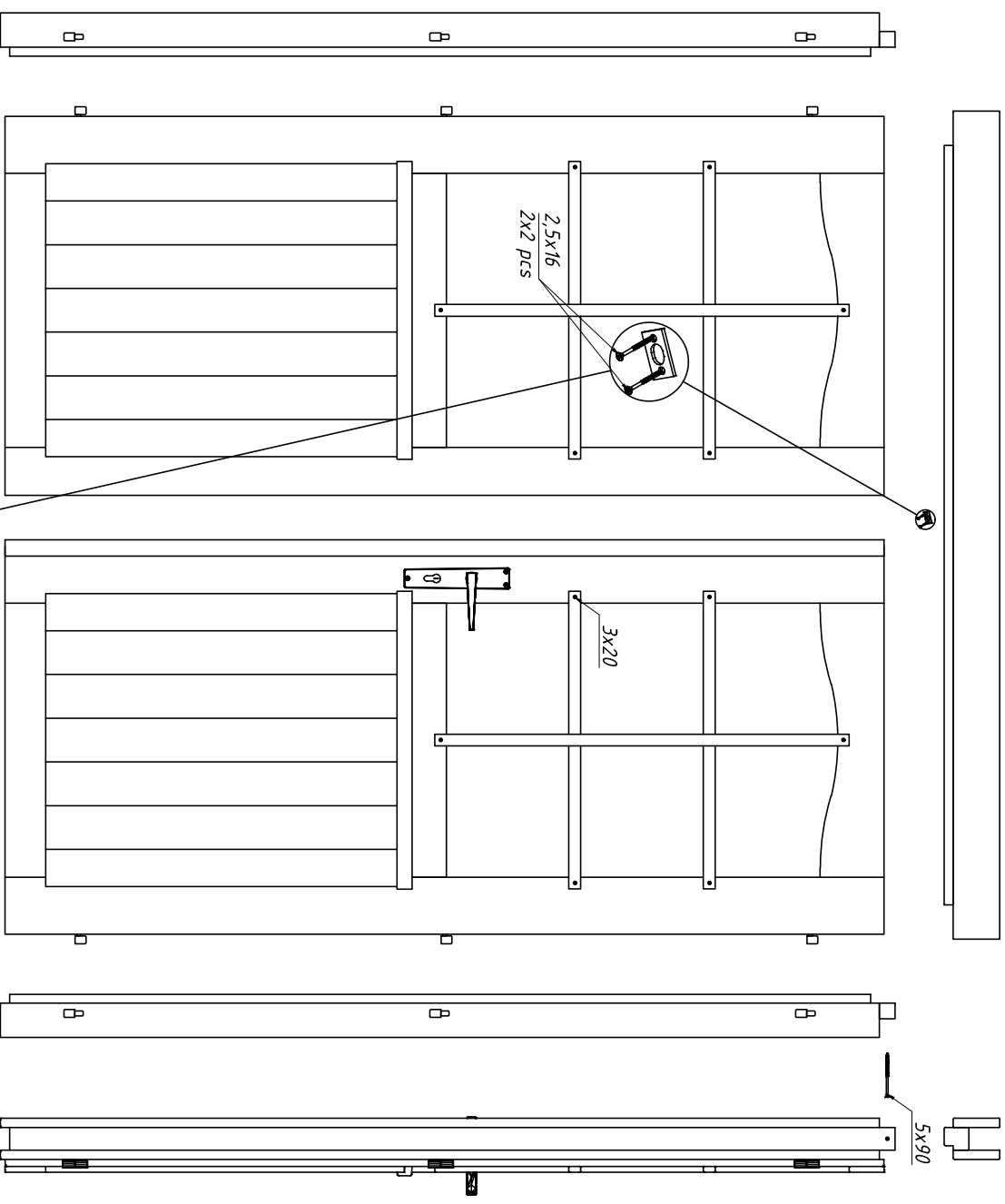

- * The specification may vary depending on the specific model.
- * Die Spezifikation können je nach Modell unterschiedlich sein.
- * Les spécifications peuvent varier selon le modèle spécifique.
- * Dependiendo del modelo, la especificación puede cambiar.
- * Le specifiche possono variare a seconda del modello.
- * Tekniset tiedot voivat vaihdella mallista riippuen.
- * Spezifikationen kan variera beroende på den specifika modellen.

5x90

5x90