

Installation manual

Montageanleitung • Notice de montage • Istruzioni per il montaggio
Manual de montaje • Monteringsanvisning • Installatiegids

Log cabin FRG44-4735

Blockhaus • Maisonnette en poutres • Casa di travi • Casa de jardin • Anneks • Tuinhuis

Width 470 x Depth 350 cm











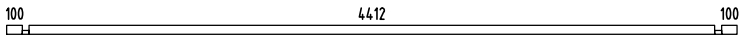
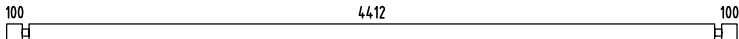
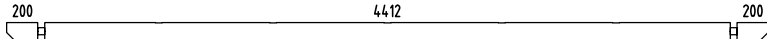

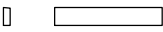
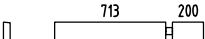
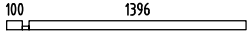
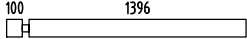

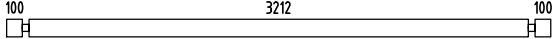
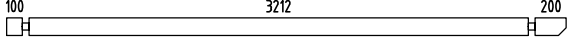
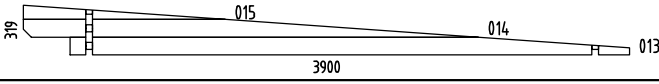
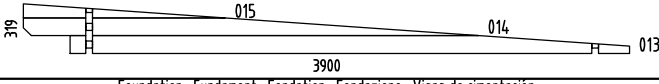
Breite/Tiefe • Largeur/Profondeur • Lunghezza/Profondità • Ancho/Profundidad • Bredder/Dybde • Breedte/Diepte

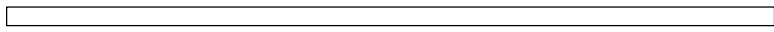
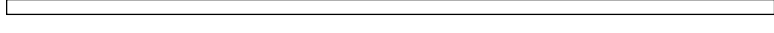
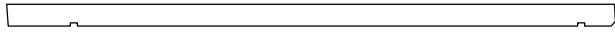
Log thickness 44 mm



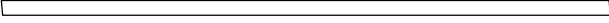







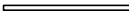















Bohlenstärke • Épaisseur des murs • Spessore delle pareti • Grosor de pared • Tykkelse • Wanddikte





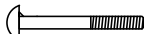

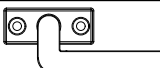
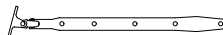

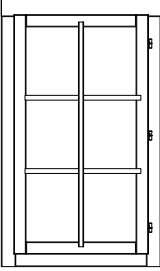

The producer shall have the right to make technical changes to the product • Technische Änderungen vorbehalten • Le producteur réserve le droit d'effectuer des modifications techniques au produit • Il produttore mantiene il diritto di apportare modifiche tecniche al prodotto • Reservado el derecho a modificaciones técnicas • Produsent forbeholder seg retten til å endre tekniske egenskaper ved produktet • Alle rechten en technische wijzigingen voorbehouden

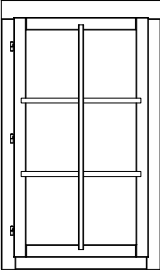
Pos	SPECIFICATION-STÜCKLISTE-NOMENCLATURE-ELEMENTI-ESPECIFICACIÓN "FRG44-4735"	Pcs	Profile (mm)	Length (mm)
001		1	44x57	4700
002		18	44x114	4700
003		2	44x114	4900
004		2	44x114	957
005		8	44x114	691
006		2	44x114	957
007		2	44x57	1540
008		10	44x114	1540
009		22	44x114	530
010		22	44x114	305
011		34	44x114	3500
012		2	44x114	3600
WA-1		1		
WB-1		1		
AR1	Foundation- Fundament- Fondation- Fondazione- Vigas de cimentación 	7	70x45	4490
CoB1	Covering board- Deckbrett- Madrier de couverture- Tavola di copertura- Listón de cubierta 	1	19x120	4940
CoB2	Covering board- Deckbrett- Madrier de couverture- Tavola di copertura- Listón de cubierta 	2	19x95	4940
RoR1	Rafter- Sparre- Chevron- Trave- Cabrio 	5	44x140	3917
RoR2	Rafter- Sparre- Chevron- Trave- Cabrio 	4	44x140	200
FB2-1	Floor board- Fussbodenbrett- Madrier du plancher - Tavola pavimento- Tabla de suelo 	50	89x19	3205
RB2-1	Roof board- Dachbrett- Madrier du toit- Tavola	44	89x19	980
RB2-2	tetto- Tabla de tejado 	44	89x19	3920
FaB6-1	Facia board- Giebelblende- Écran frontal- Schermo frontone- Tabla de facia 	4	19x95	3920
FIB2-1	Floor beading- Fussbodenleiste- Baguette du plancher- Listello pavimento- Listón de suelo 	7	19x19	2244
RE2-1	Roof edge reinforcement- Dachrandleiste- Baguette en bordure du toit- Rinforzo bordo tetto- Refuerzo borde tejado 	2	32x40	3210
QTihe ndTPE 8mm-1	Seal- Gummidichtung- Joint d'isolation- Guarnizione- Burlate 	2	A44-81	3700

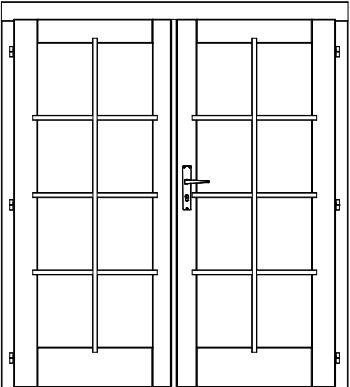

Pos	SPECIFICATION-STÜCKLISTE-NOMENCLATURE-ELEMENTI-ESPECIFICACIÓN "FRG44-4735"	Pcs	Profile (mm)	Length (mm)	
QTi ndTPE 8mm-2	Seal- Gummidichtung- Joint d'isolation- Guarnizione- Burlate		1	TU44-81R	5500
SlA10-1	Slaf- Leiste- Baguette- Listello- Listón		1	19x45	1620
StB1-1	Storm brace- Sturmleiste- Protection contre le vent- Antivento- Protector contra tormentas		2	25x45	2050
StB1-2	Storm brace- Sturmleiste- Protection contre le vent- Antivento- Protector contra tormentas		2	25x45	2250
Fim	-Fixing kit- Befestigungsset- Moyens de fixation- Materiale di fissaggio- Kit de fijación		1	USE	
QPUP 08x80	Bolt -Schloss-schraube -Boulon- Bullone- Perno- M8x80mm PUP0		8	StB1-x	
QULSy damik 30/35	Cylinder- Zylinderschloss- Serrure a mortaiser- Serratura a cilindro- Bombin- 30.35		1	TU44-81R	
QULKat eHOBEk	Door fittings- Türbeschlag- Ferrure- Ferramenta porta- Manilla puerta- QULKateHOBEk		1	TU44-81R	
QULli nkHOBE	Door fittings- Türbeschlag- Ferrure- Ferramenta porta- Manilla puerta- QULlinkHOBE		1	TU44-81R	
QServa riiviv astus120	Keeper- Schliessblech- Tole- Lamiera- Aldaba de candado		1	TU44-81R	
QNA1 4x40M	Nail- Nagel- Clou- Chiodo- Clavo- 1.4x40mm		40	FB2-1	
QNA2 2x50Zn	Nail- Nagel- Clou- Chiodo- Clavo- 2.5x50mm		380	FB2-1	
QNA3 x70ZN	Nail- Nagel- Clou- Chiodo- Clavo- 3x70mm		450	RB2-1	
QMU8	Nut- Schraubenmutter- Écrou- Dado- Tuerca- M8mm		8		
QKR2_5 x16kZn	Screw- Schraube- Vis- Vite- Tornillo- 2.5x16mm		2		
QKR3 x20ZN	Screw- Schraube- Vis- Vite- Tornillo- 3x20mm		28	TU44-81R; A44-81	
QKR4 5x50ZN	Screw- Schraube- Vis- Vite- Tornillo- 4.5x50mm		120	CoBx; FaBx; RE2-1;...	
QKR4 5x70ZN	Screw- Schraube- Vis- Vite- Tornillo- 4.5x70mm		20	001; 004; 006; 007	
QKR5 x90ZN	Screw- Schraube- Vis- Vite- Tornillo- 5x90mm		24	TU44-81R; 005; 004	
QKR6x 120ZN	Screw- Schraube- Vis- Vite- Tornillo- 6x120mm		8	RoR2+Wall	
QKR6x 180ZN	Screw- Schraube- Vis- Vite- Tornillo- 6x180mm		10	RoR1+Wall	
QSE8x22	Washer- Dichtscheibe- Joint- Rondella- Arandela- 8x22mm		8		
QALp ainP	Window fittings- Fenstergriff- Poigne de la fenêtre- Maniglia finestra- Manilla- QALpainP		1	A44-81	
QALp ainV	Window fittings- Fenstergriff- Poigne de la fenêtre- Maniglia finestra- Manilla- QALpainV		1	A44-81	
QAF2 40Zn	Window stop- Fensterfeststelle- Crémaillère- Fissativo finestra- Fijador de ventana- QAF240Zn		2	A44-81	
	Object name "FRG44-4735"			Page	2/3

Pos	SPECIFICATION-STÜCKLISTE-NOMENCLATURE-ELEMENTI-ESPECIFICACIÓN "FRG44-4735"	Pcs	
A44-81L	<p data-bbox="459 230 1027 259">Window - Fenster - Fenetre - Finestra-Ventana 700x1210</p>   <p data-bbox="842 398 959 427">600x1110mm</p>	1	
A44-81R	<p data-bbox="459 633 1027 663">Window - Fenster - Fenetre - Finestra-Ventana 700x1210</p>   <p data-bbox="842 801 959 831">600x1110mm</p>	1	
TU44-81R	<p data-bbox="517 1037 968 1066">Door - Tür - Porte - Porta-Puerta 1610x1822</p>   <p data-bbox="924 1189 1078 1218">1510x1753mm</p>	1	
 	Object name "FRG44-4735"		Page 3/3

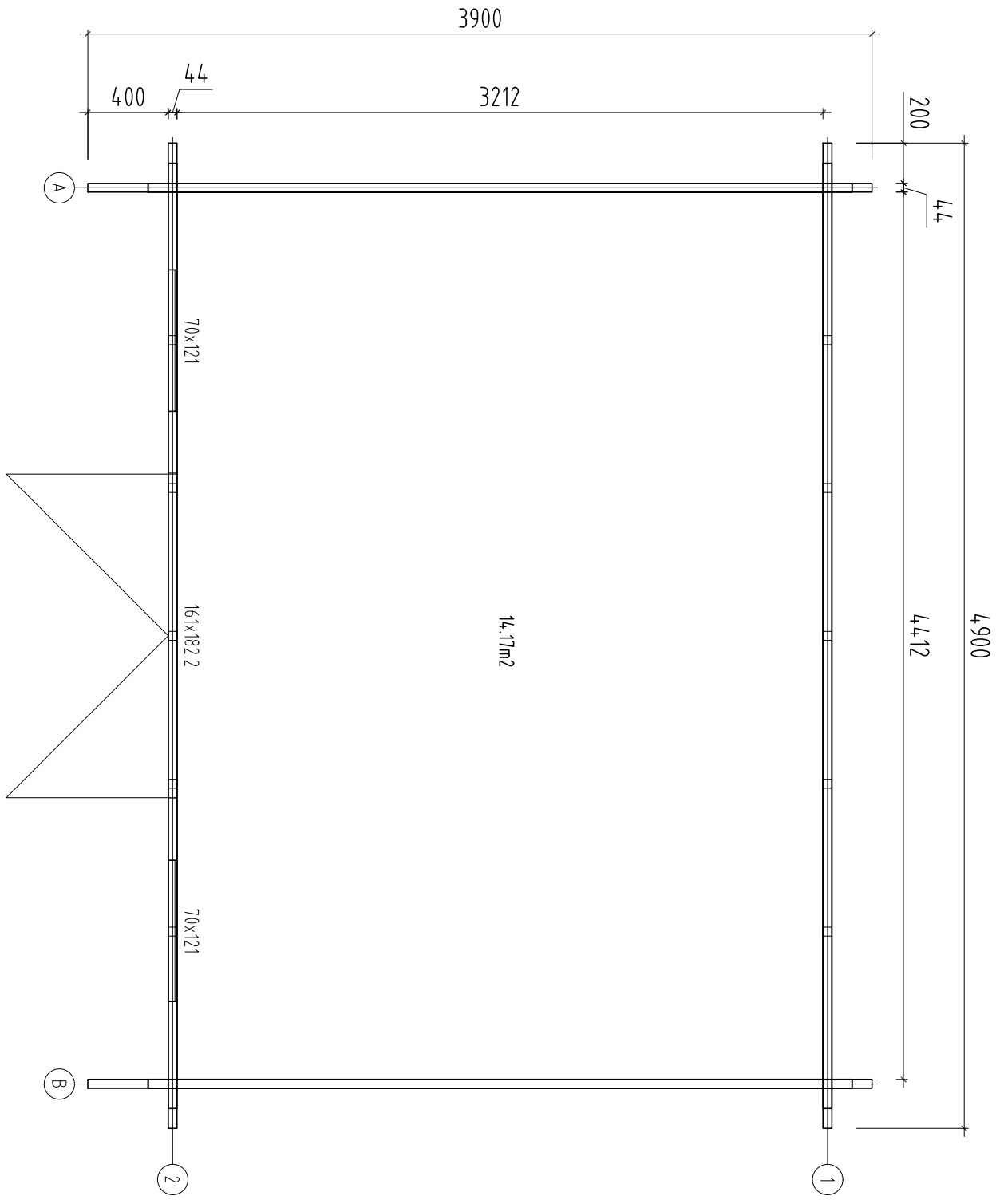

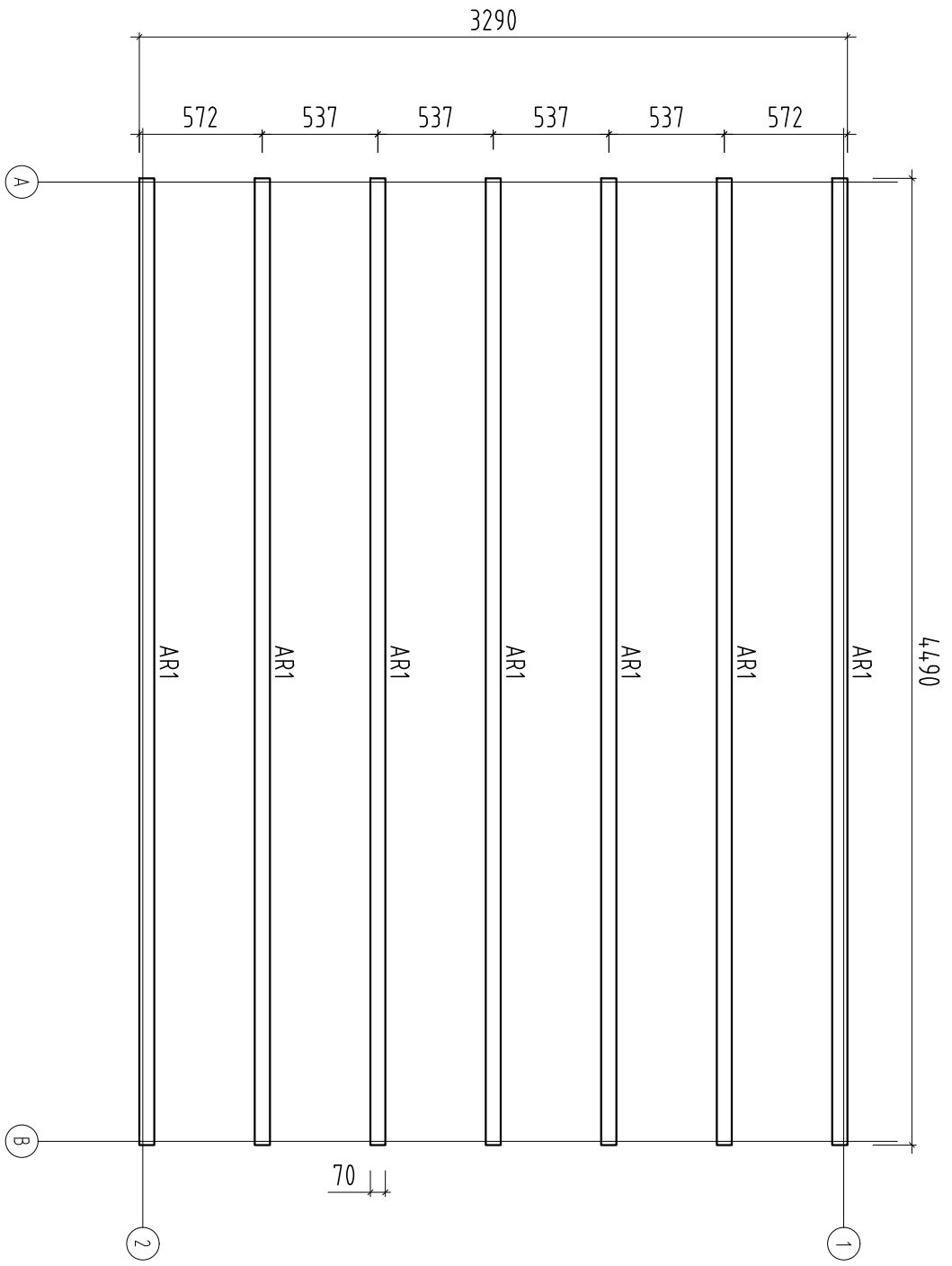

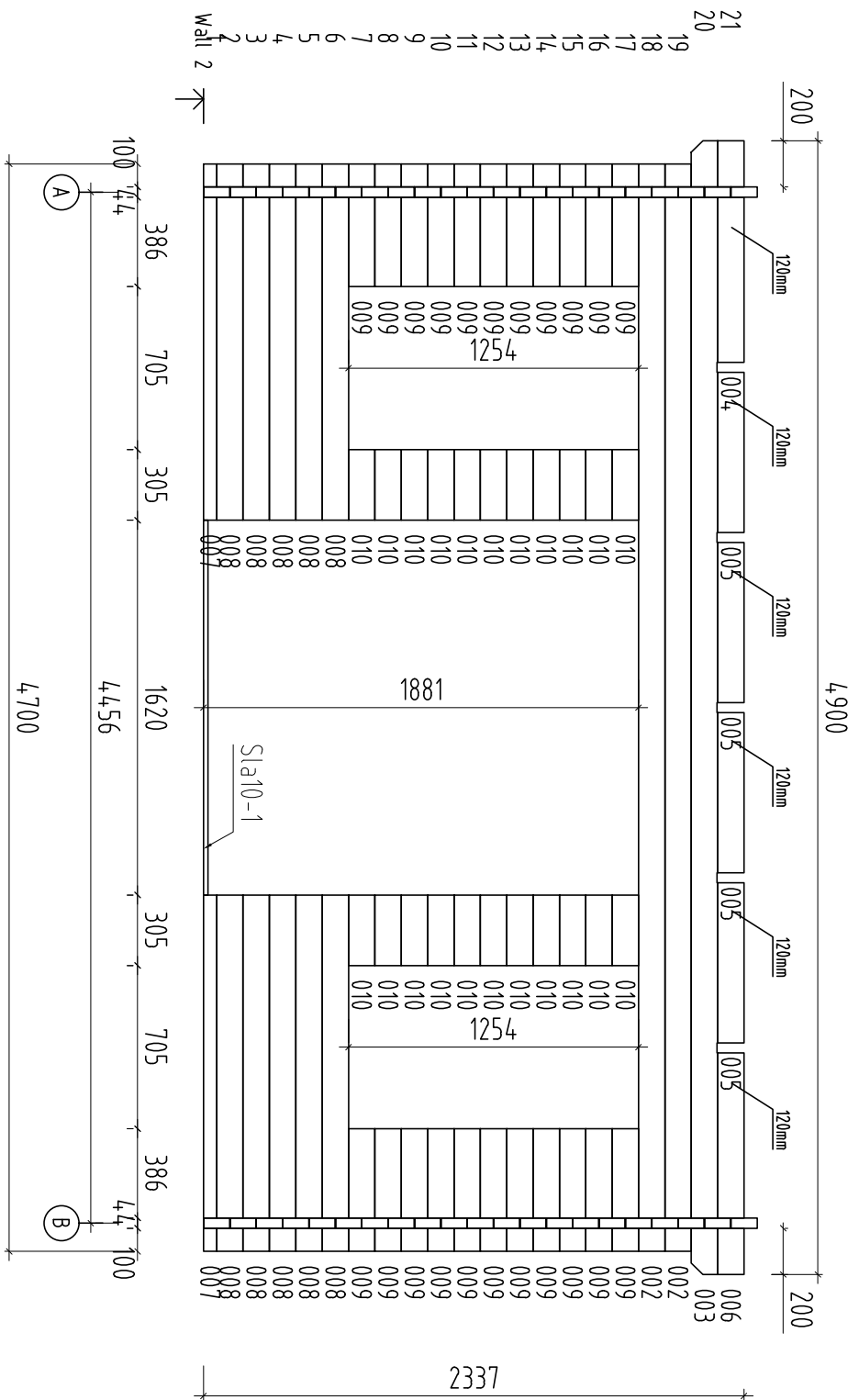

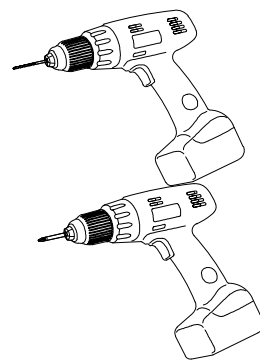
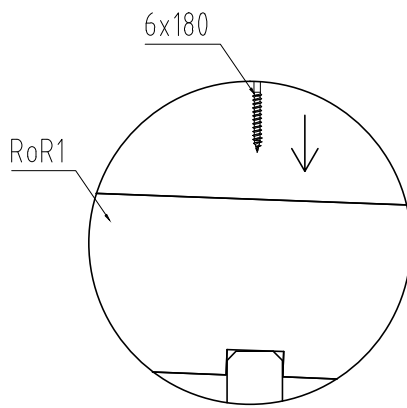
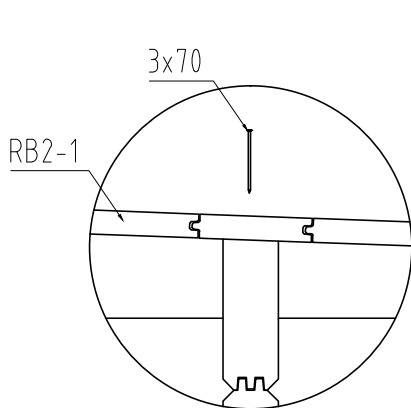
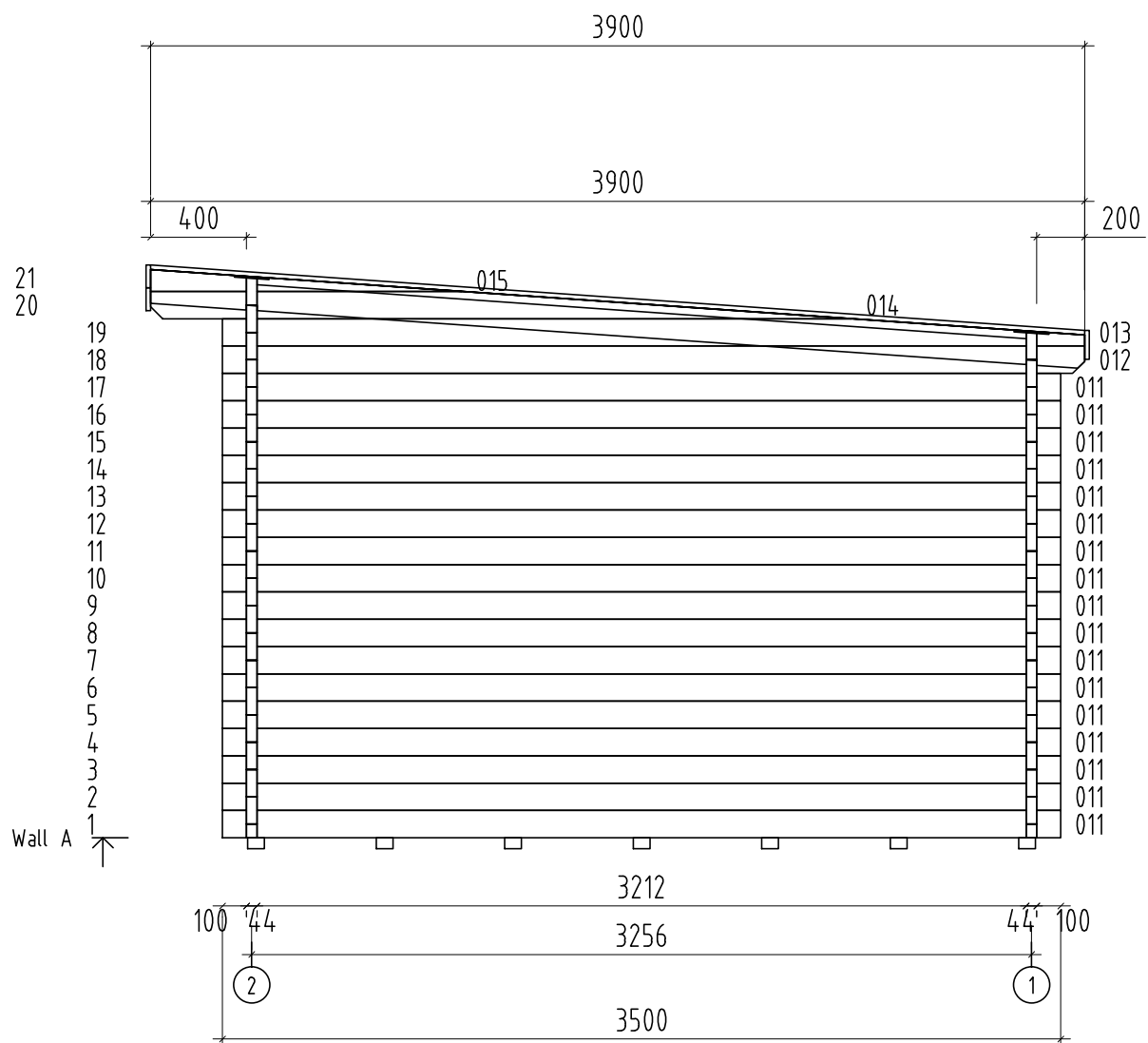

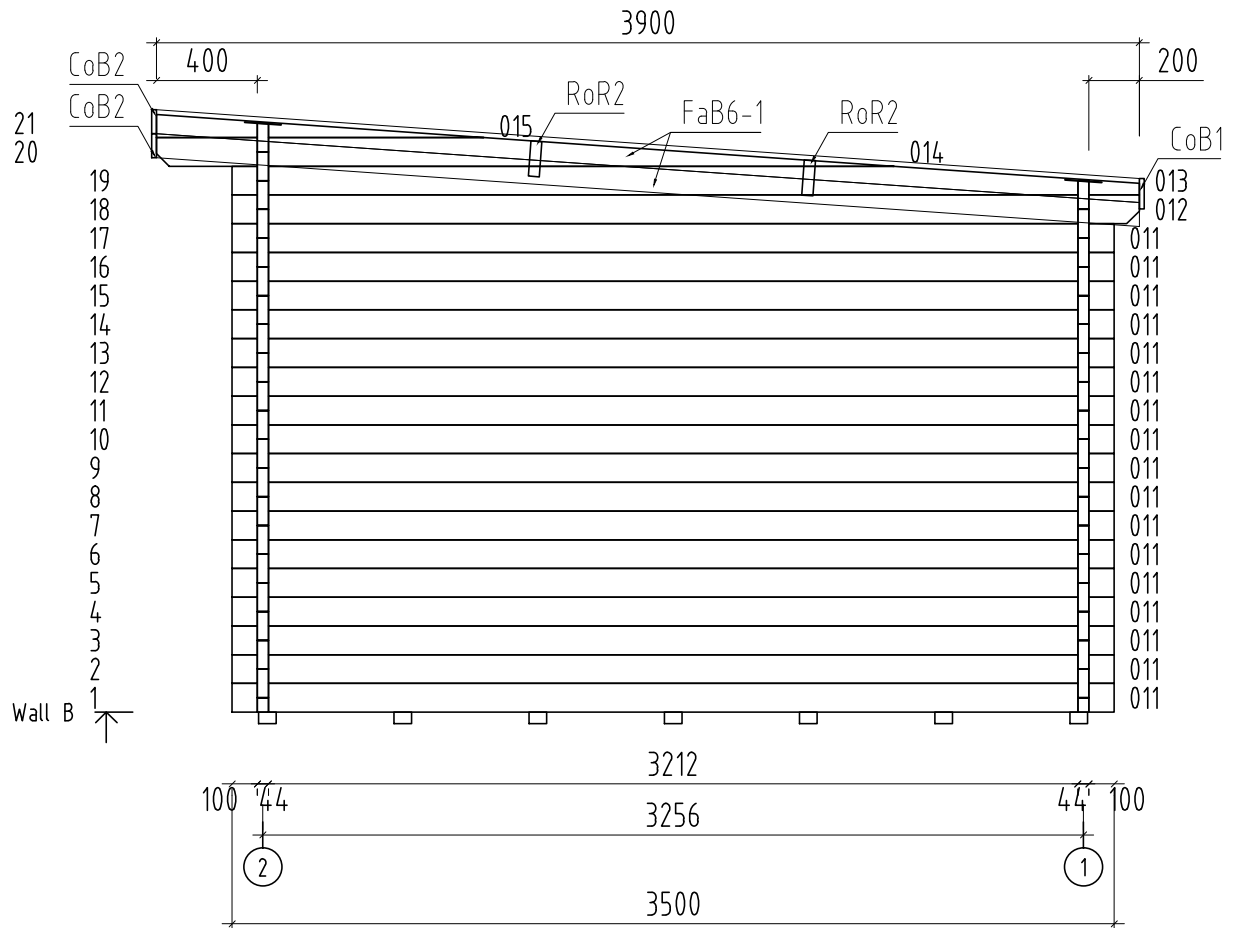

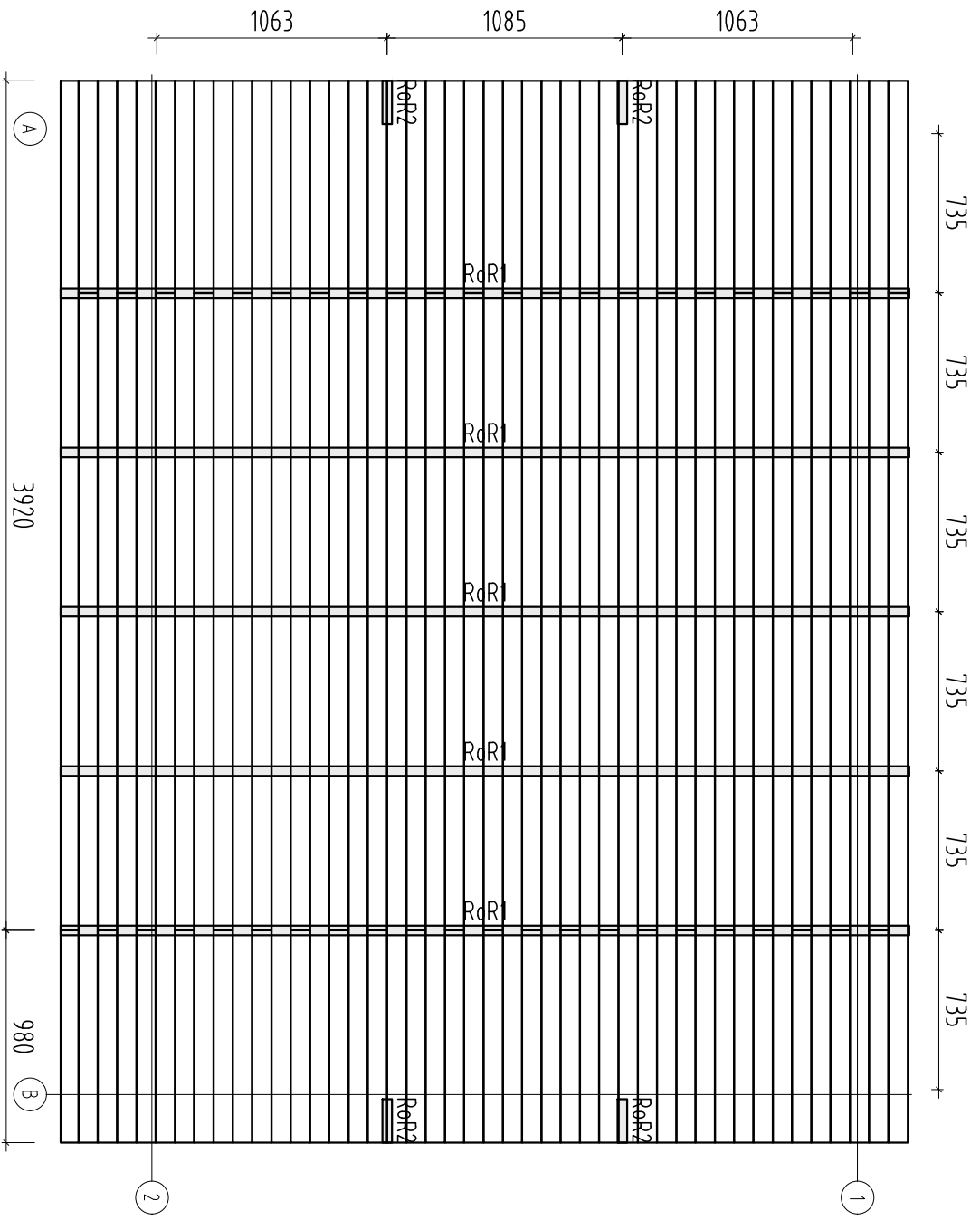

Rafter - Sparre - Chevron - Trave - Cabrio
 Roof board - Dachbrett - Madrier du toit - Tavola
 tetto - Tabla de tejado

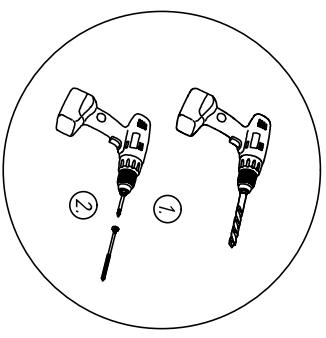
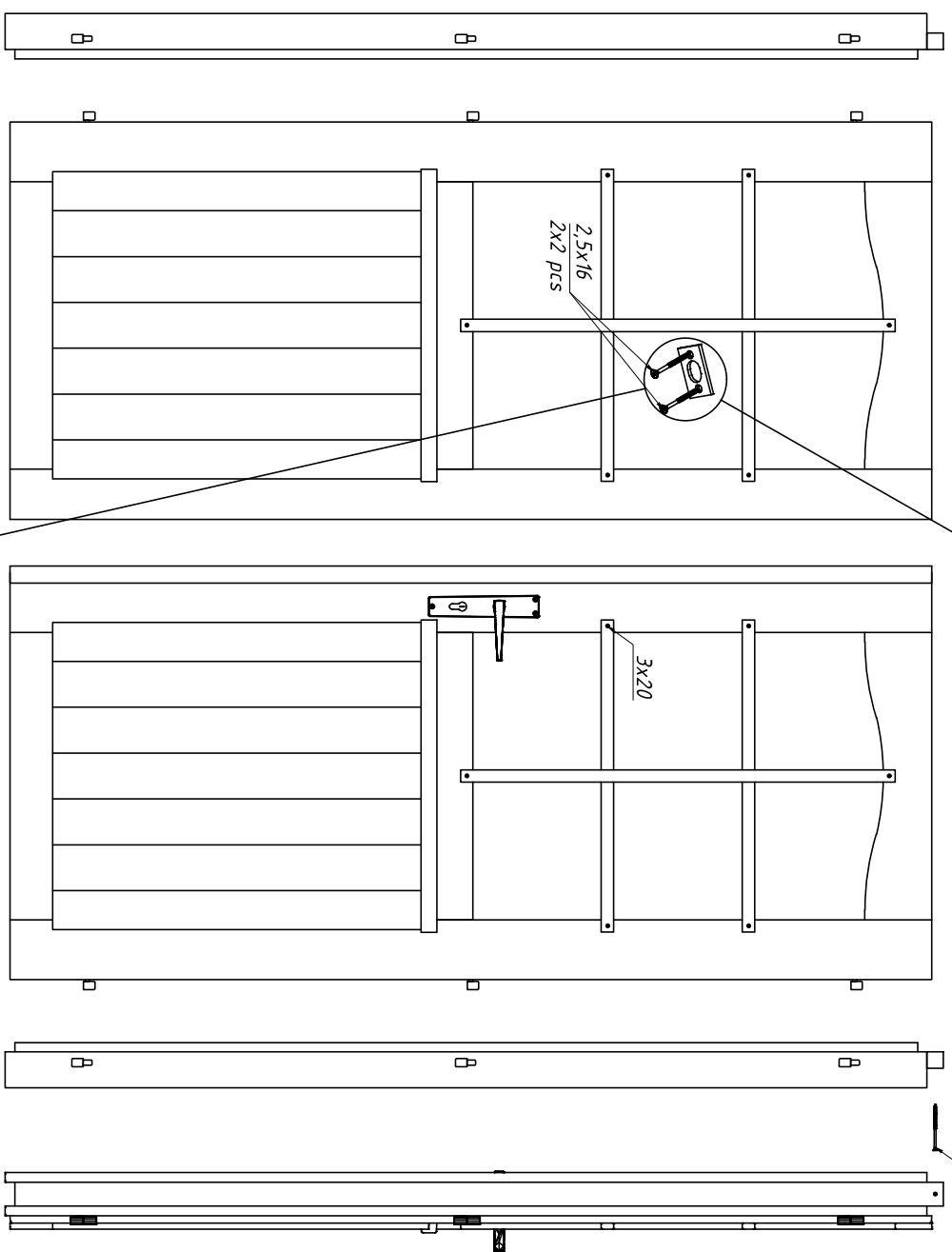
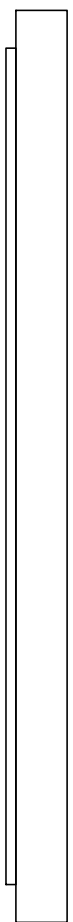
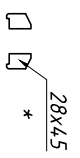
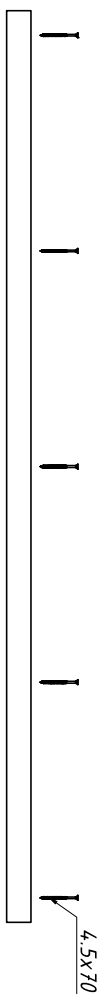

* The specification may vary depending on the specific model
 * Die Spezifikation können je nach Modell unterschiedlich sein
 * Les spécifications peuvent varier selon le modèle spécifique
 * Dependiendo del modelo, la especificación puede cambiar
 * Le specifiche possono variare a seconda del modello

