

# Installation manual

Montageanleitung • Notice de montage • Istruzioni per il montaggio  
Manual de montaje • Monteringsanvisning • Installatiegids • Asennusohje • Installationsmanual

## Element house ELD18-3334

Elementhaus • Maison à modules • Casetta in elementi • Cobertizo • Redskapsbod • Element huis • Elementti  
piharakennus • Friggebod

Width 330 x Depth 344 cm

Breite/Tiefe • Largeur/Profondeur • Lunghezza/Profondità • Ancho/Profundidad • Bredde/Dybde • Breedte/Diepte •  
Leveys/Pituus • Bredd/Längd

Log thickness 18 mm

Bohlenstärke • Épaisseur des murs • Spessore delle pareti • Grosor de pared • Tykkelse • Wanddicke •  
Seinän paksuus • Väggtjocklek





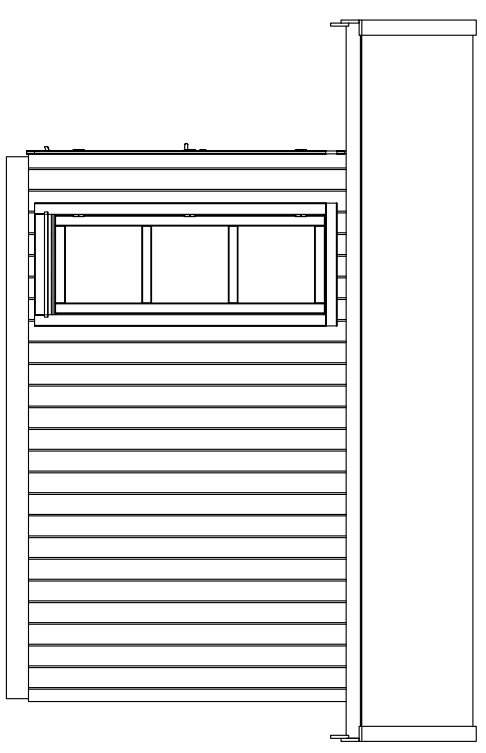
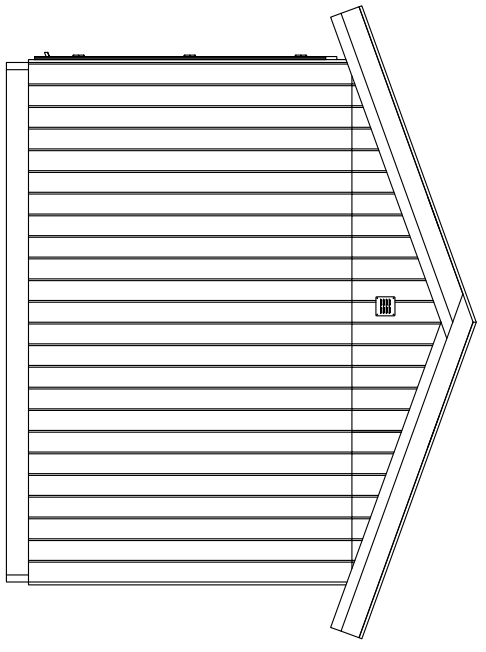
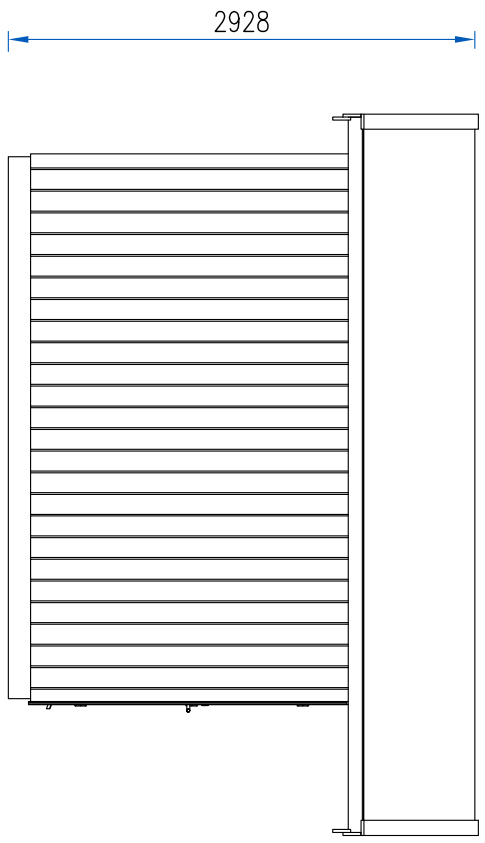
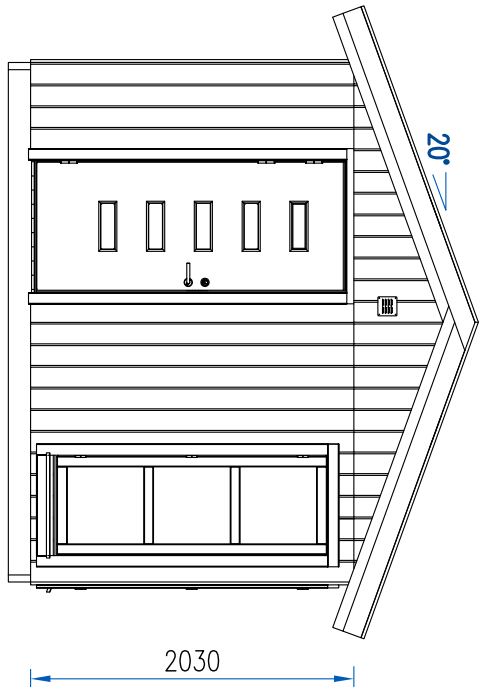

The producer shall have the right to make technical changes to the product • Technische Änderungen vorbehalten • Le  
producteur réserve le droit d'effectuer des modifications techniques au produit • Il produttore mantiene il diritto di apportare  
modifiche tecniche al prodotto • Reservado el derecho a modificaciones técnicas • Produsent forbeholder seg retten til å endre  
tekniske egenskaper ved produktet • Alle rechten en technische wijzigingen voorbehouden • Valmistaja pidättää oikeuden tehdä  
tuotteeseen teknisiä muutoksia • Tillverkaren har rätt att utföra tekniska förändringar för produkten



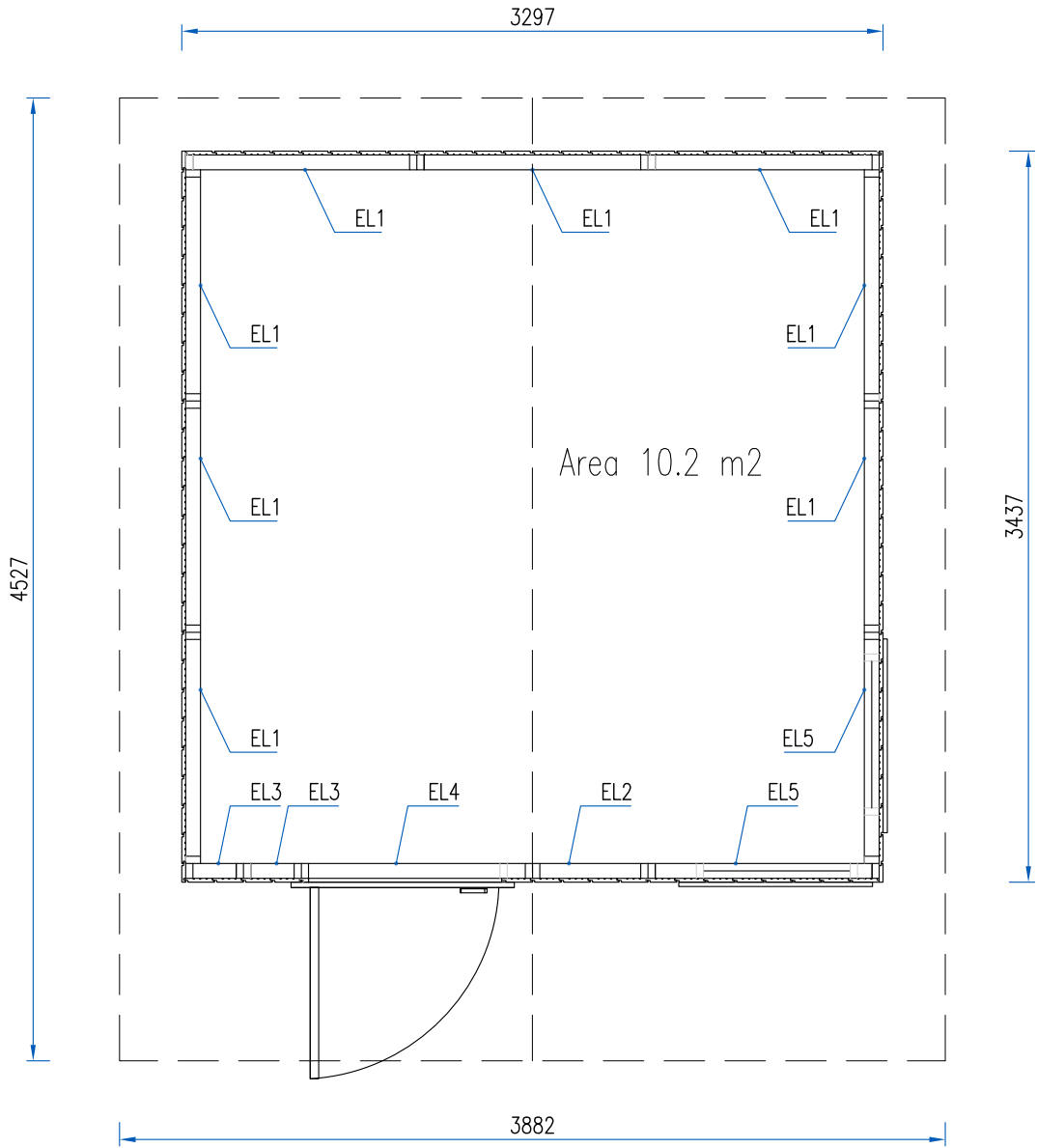

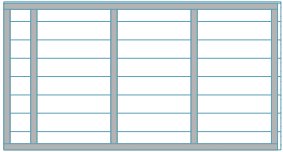
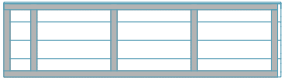

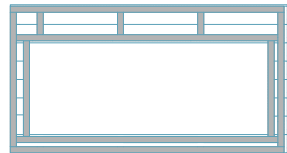

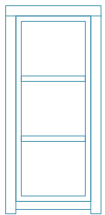







Ly\_10.2 m2



Ly 10.2 m<sup>2</sup>  
Plan

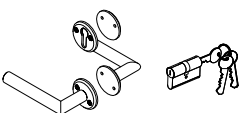
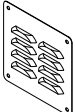

EL1		2055 x 1097 x 88	8
EL2		2055 x 553 x 88	1
EL3		2055 x 281 x 88	2
EL4		2055 x 1097 x 88	1
EL5		2055 x 1097 x 88	2
EL6		3157 x 727 x 88	2
U105-15-920L	 <p data-bbox="491 1659 794 1816"> U1  U2  U1 - 19x40x980 2 pcs  U2 - 19x70x1980 4 pcs </p>	870 x 1985 x 105	1
A105-3R	 <p data-bbox="491 1928 794 2101"> A1  A2  A3  A1 - 19x70x830 2 pcs  A2 - 19x70x1820 4 pcs  A3 - 19x70x630 2 pcs </p>	660 x 1740 x 105	2

1	 Impregnated	45 x 145 x 3401	2
2	 Impregnated	45 x 145 x 3171	7
3		19 x 89 x 3401	37
4		70 x 140 x 4450	1
5		70 x 140 x 4450	4
6		16 x 89 x 2040	100
7		16 x 120 x 2250	8
8		32 x 40 x 2225	4
9		16 x 95 x 4490	2
10		18 x 135 x 2055	4
11		16 x 95 x 2115	4
F1		Ø 6 x 120	45
F2		Ø 4.5 x 70	140
F3		Ø 4 x 50	210
F4		Ø 2.5 x 16	8
F5		Ø 3 x 70	600
F6		QULLink/ASSA QULSydamik/ASSA QULSydamikkate/ASSA	1 set
F7		120 x 120	2

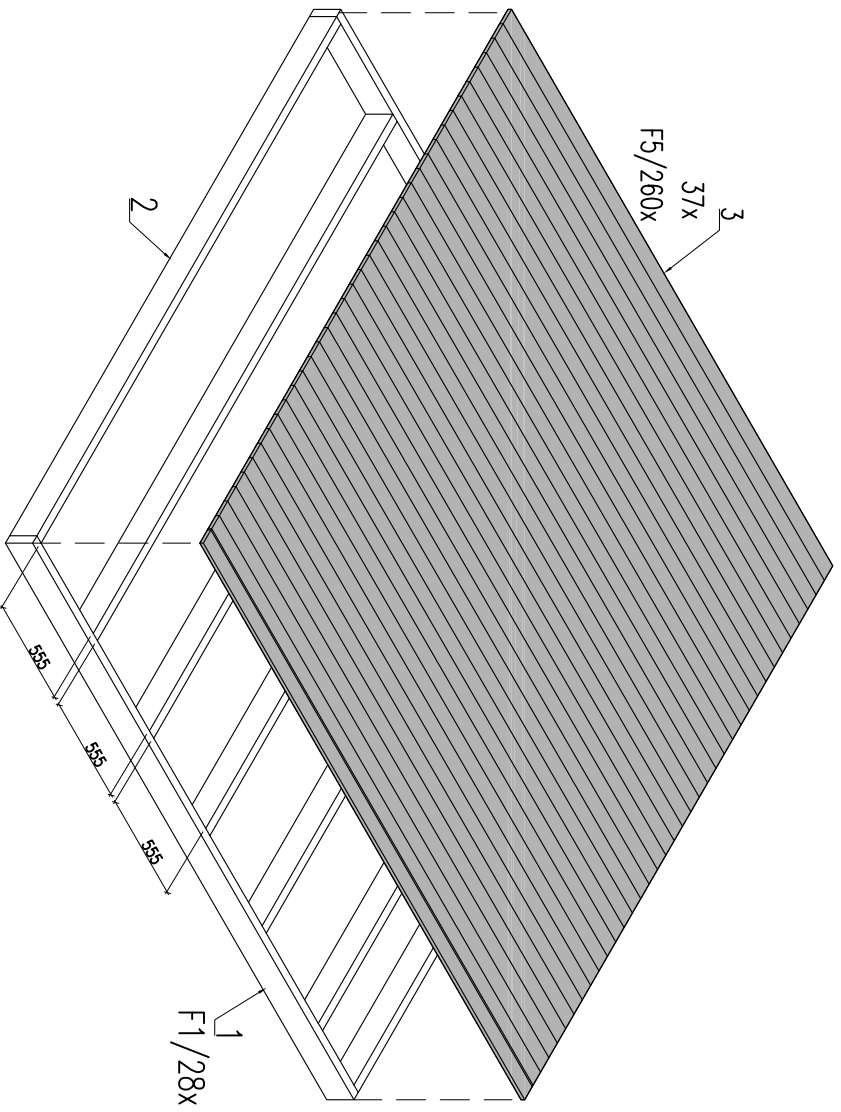

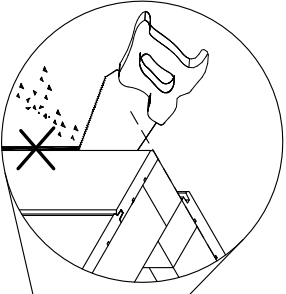

Pos.10  
F3 4x

F2  
d'5x

F2  
d'3x

Pos.10  
F3 4x

Pos.10  
F3 4x

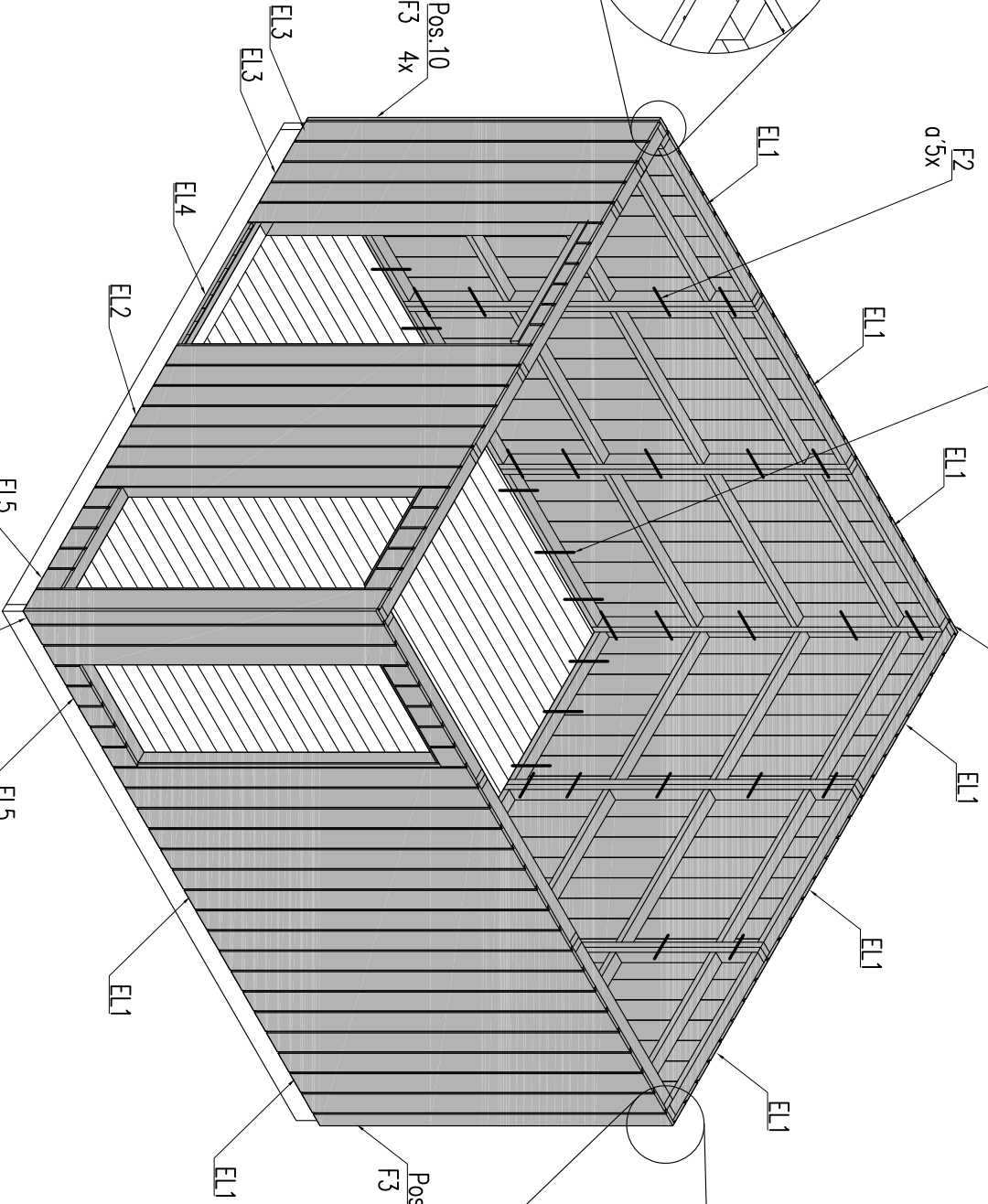
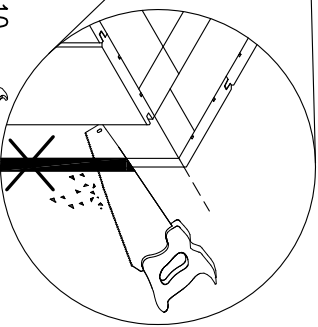

Pos.10  
F3 4x

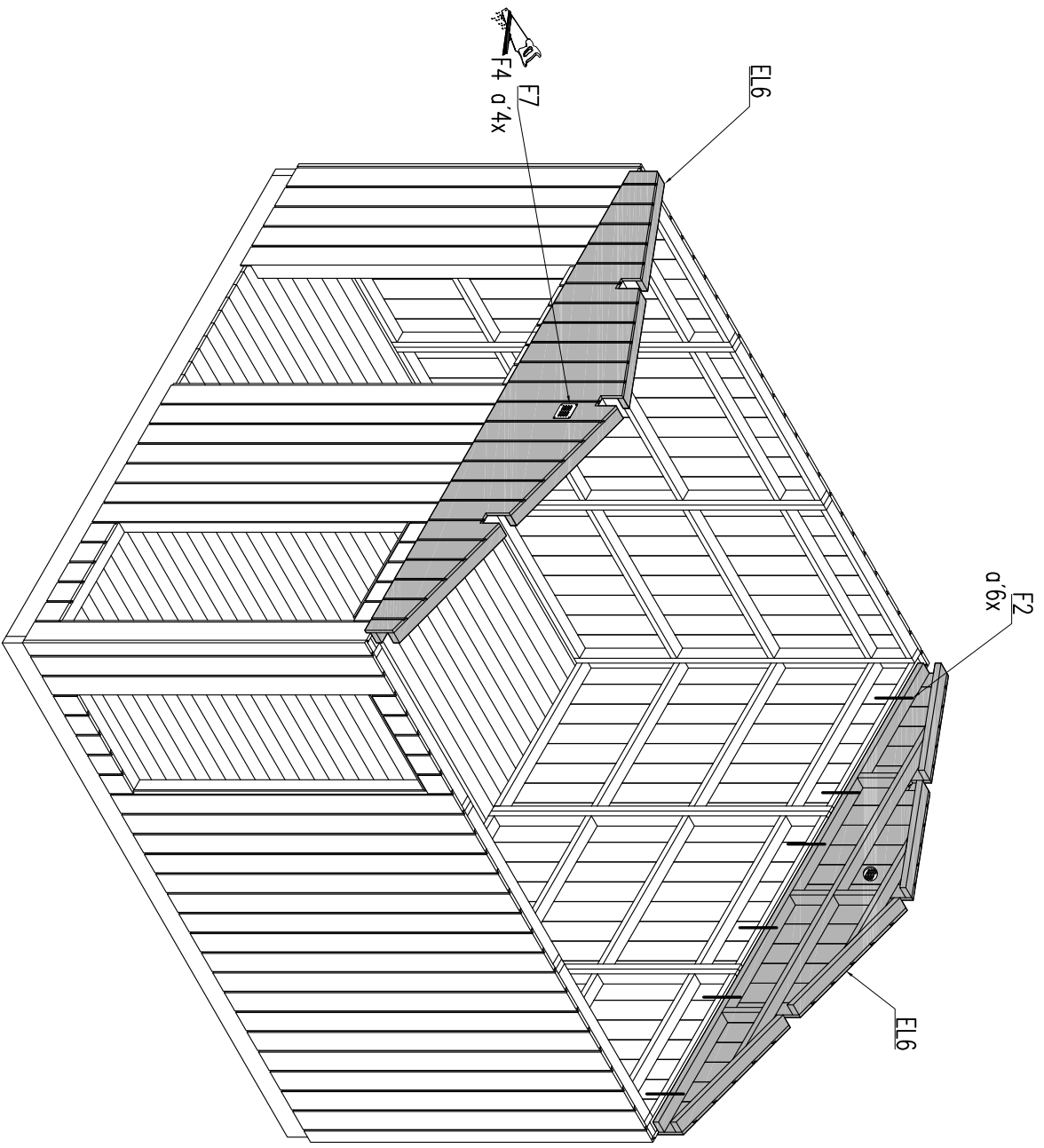



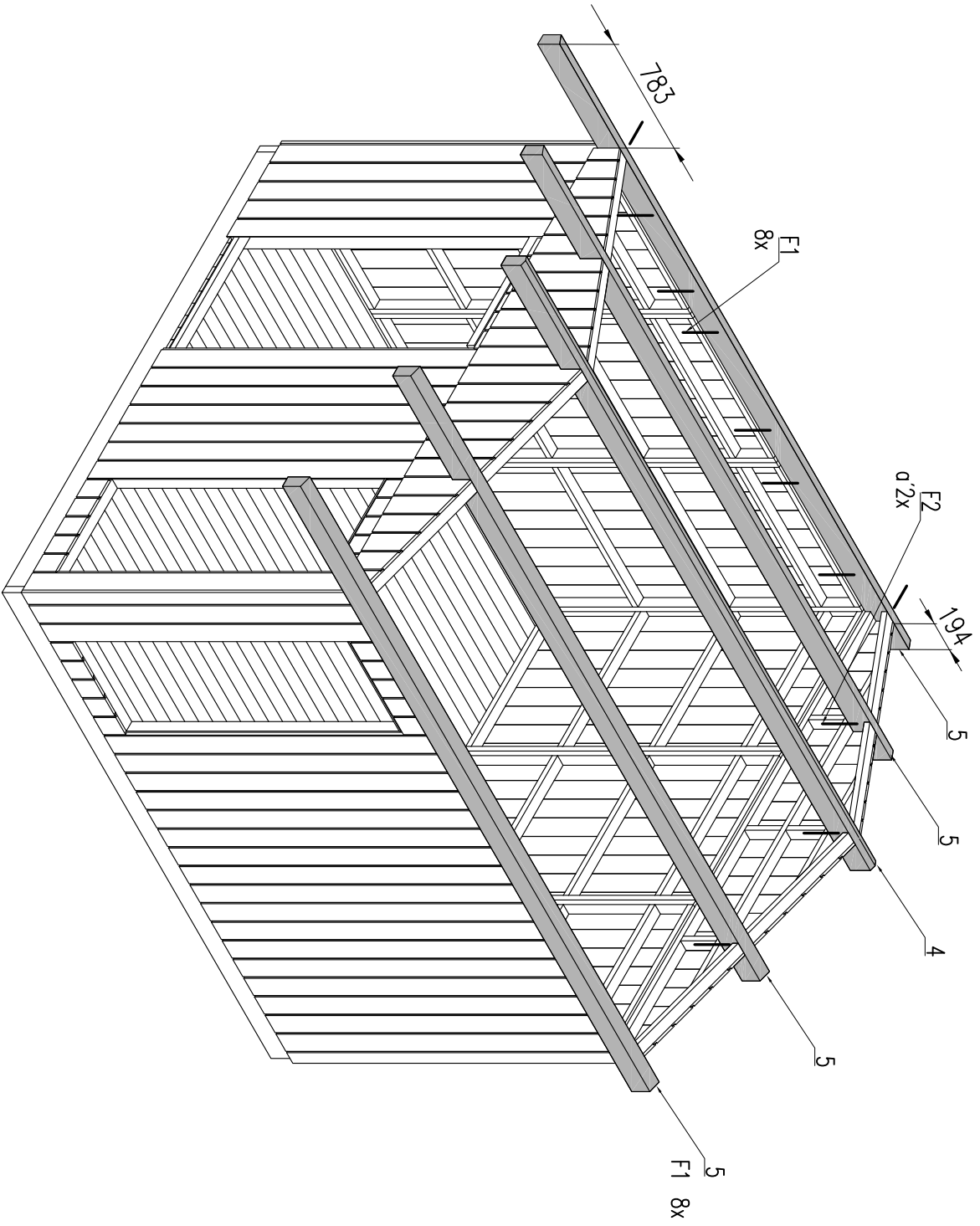

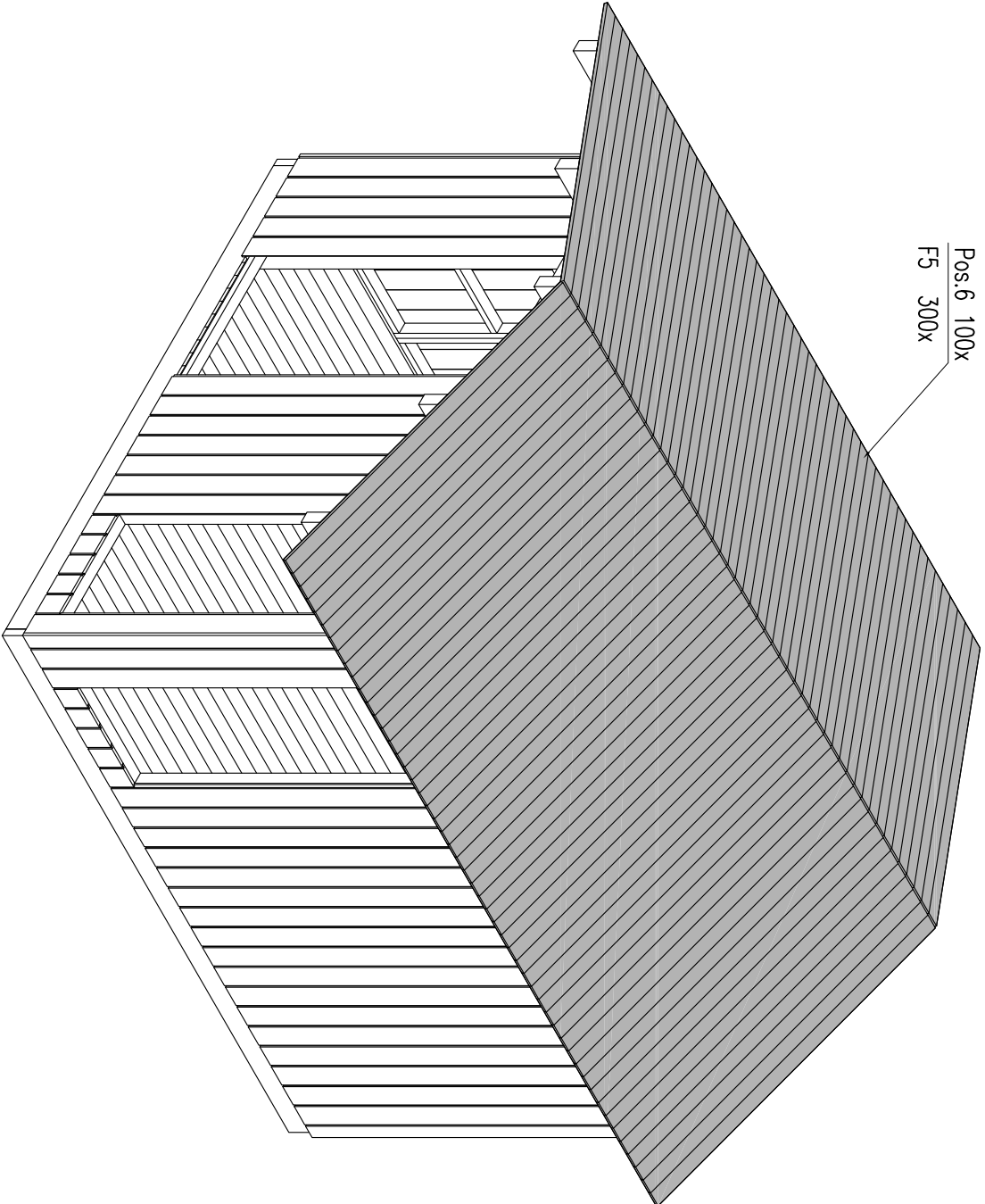

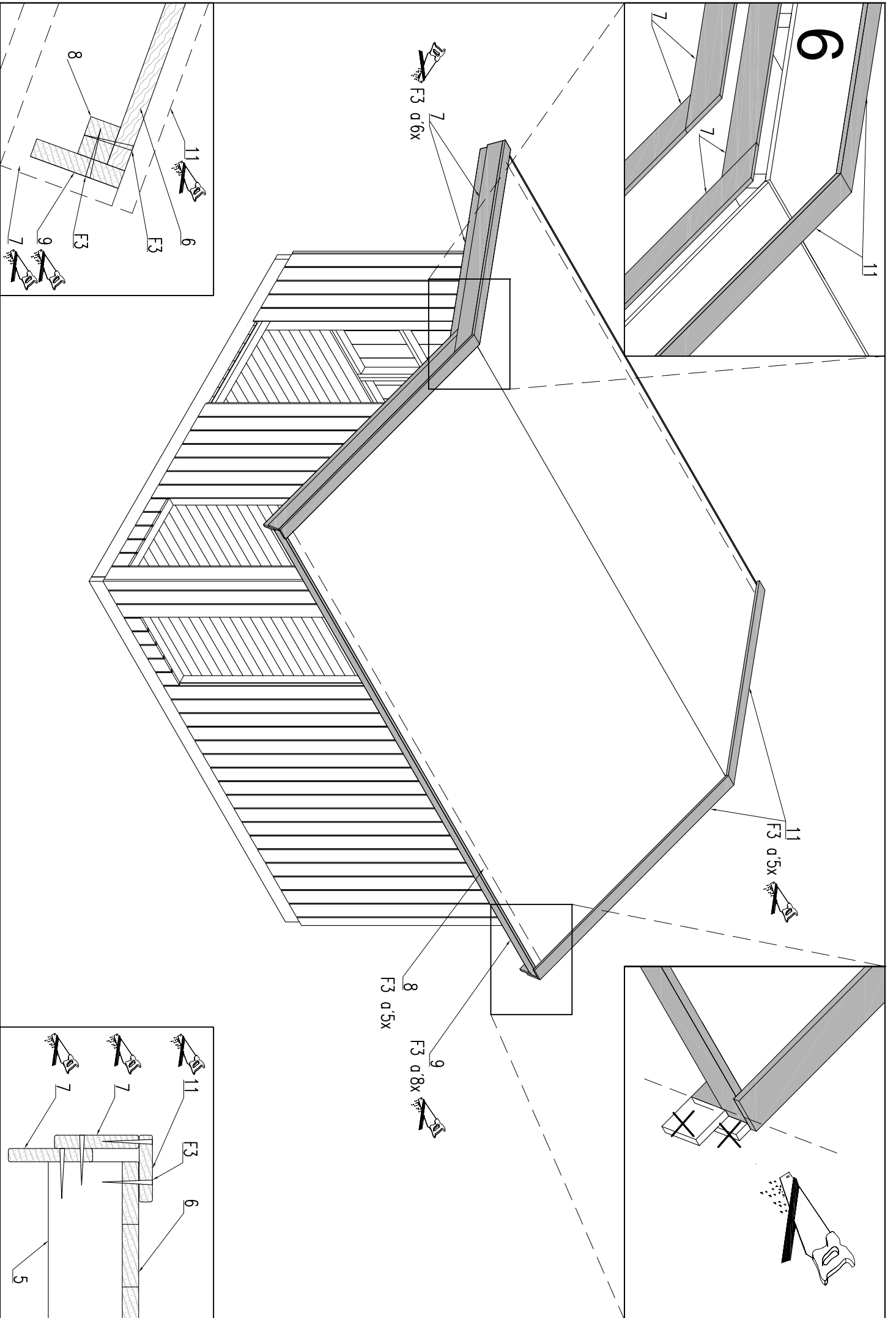

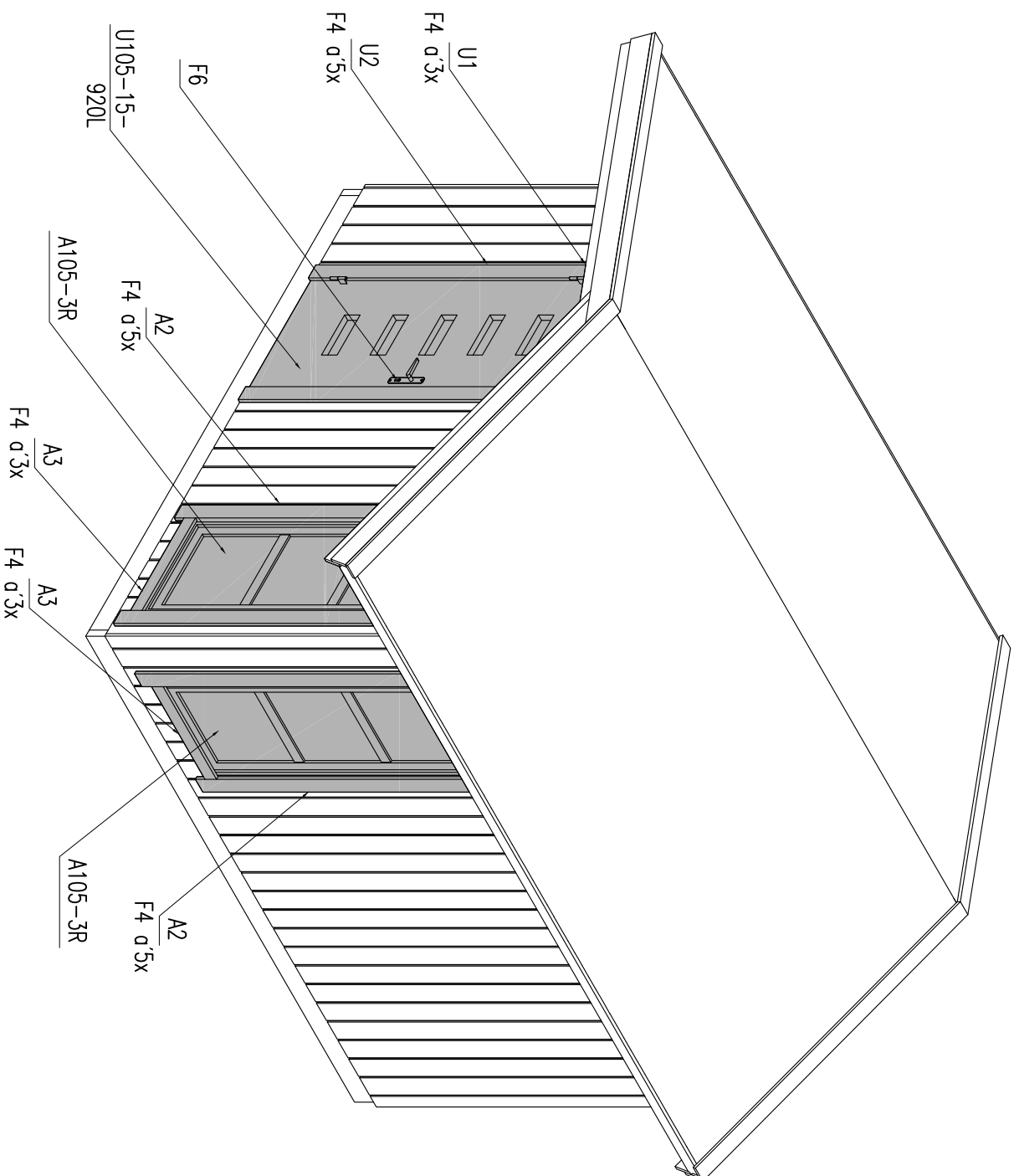

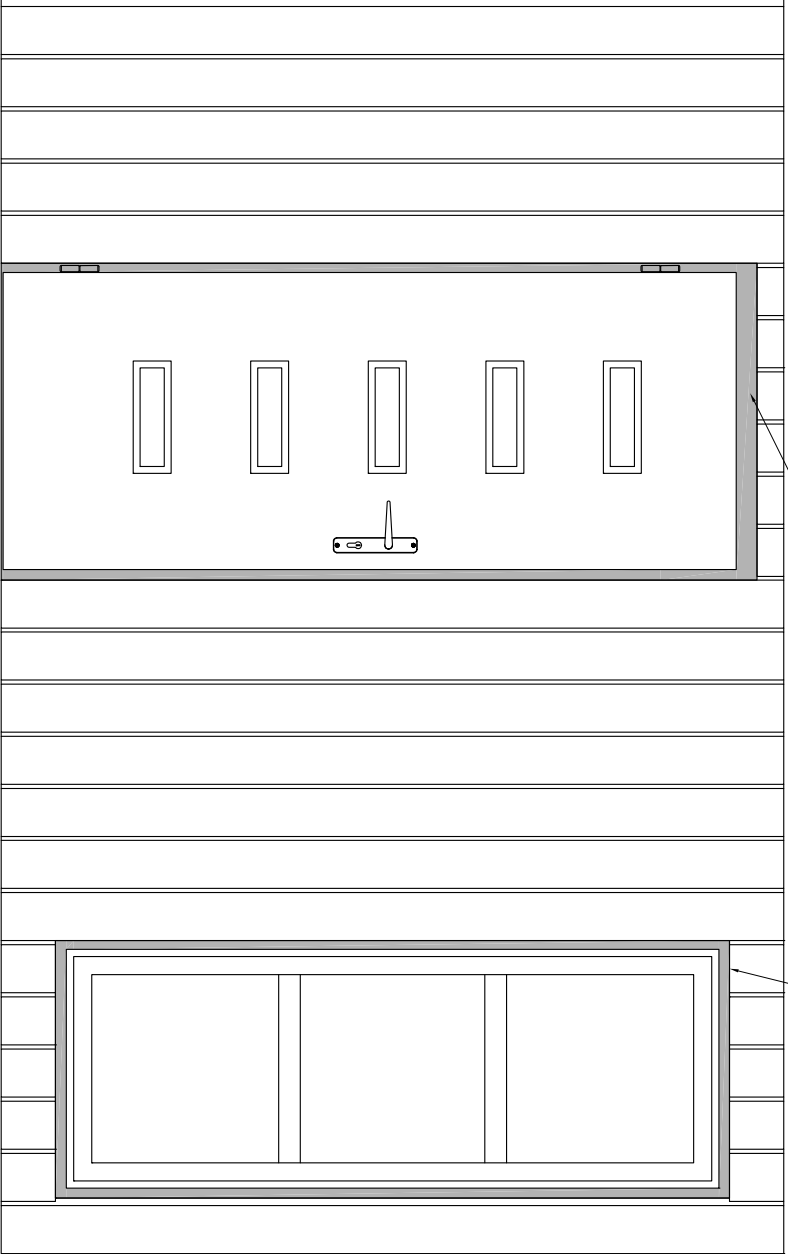

Montage foam  
Not included!