

Installation manual

Montageanleitung • Notice de montage • Istruzioni per il montaggio
Manual de montaje • Monteringsanvisning • Installatiegids

Log cabin FRD44-3857

Blockhaus • Maisonnette en poutres • Casa di travi • Casa de jardin • Anneks • Tuinhuis

Width 380 x Depth 570 cm

Breite/Tiefe • Largeur/Profondeur • Lunghezza/Profondità • Ancho/Profundidad • Bredde/Dybde • Breedte/Diepte

Log thickness 44 mm

Bohlenstärke • Épaisseur des murs • Spessore delle pareti • Grosor de pared • Tykkelse • Wanddikte











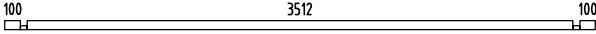
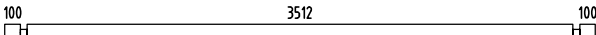
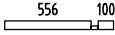
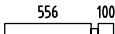
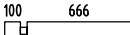
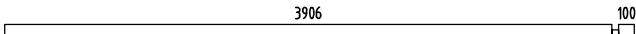

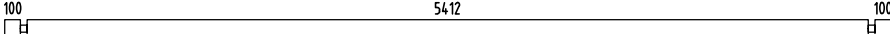
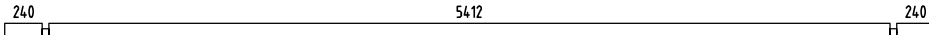
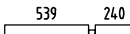

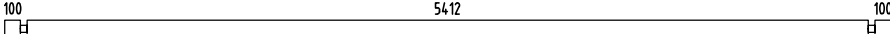
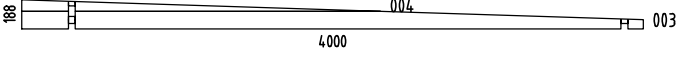
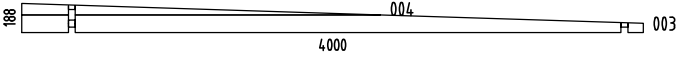
FRO44-3857

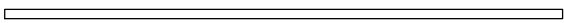

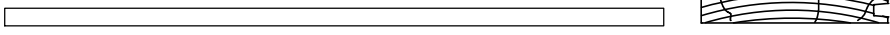
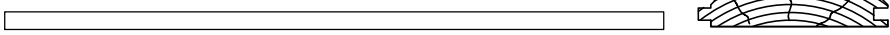
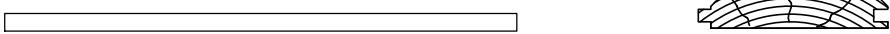



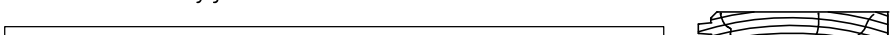

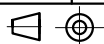

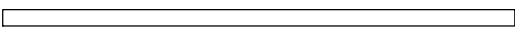
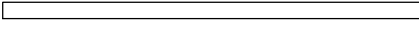







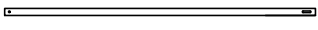
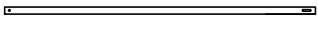

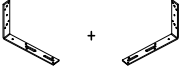

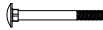

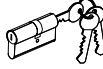

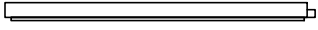

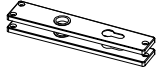











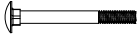

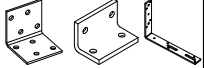



FRO44-3857-1

The producer shall have the right to make technical changes to the product • Technische Änderungen vorbehalten • Le producteur réserve le droit d'effectuer des modifications techniques au produit • Il produttore mantiene il diritto di apportare modifiche tecniche al prodotto • Reservado el derecho a modificaciones técnicas • Produsent forbeholder seg retten til å endre tekniske egenskaper ved produktet • Alle rechten en technische wijzigingen voorbehouden

| Pos | SPECIFICATION-STÜCKLISTE-NOMENCLATURE-ELEMENTI-ESPECIFICACIÓN FRD44-3857 | Pcs | Profile (mm) | Length (mm) |
|------|---|-----|-----------------|----------------|
| 001 |  | 1 | 44x57 | 3800 |
| 002 |  | 21 | 44x114 | 3800 |
| 005 |  | 2 | 44x57 | 700 |
| 006 |  | 34 | 44x114 | 700 |
| 007 |  | 22 | 44x114 | 810 |
| 008 |  | 12 | 44x114 | 4050 |
| 009 |  | 10 | 44x114 | 810 |
| 010 |  | 20 | 44x114 | 5700 |
| 011 |  | 1 | 44x114 | 5980 |
| 012 |  | 4 | 44x114 | 823 |
| 013 |  | 14 | 44x114 | 539 |
| 014 |  | 1 | 44x114 | 5700 |
| W1-1 |  | 1 | | |
| W2-1 |  | 1 | | |
| AR1 | Foundation- Fundament- Fondation- Fondazione- Vigas de cimentación  | 2 | 80x60 | 5330 |
| AR2 | Foundation- Fundament- Fondation- Fondazione- Vigas de cimentación  | 2 | 80x60 | 3590 |
| CoB2 | Covering board- Deckbrett- Madrier de couverture- Tavola di copertura- Listón de cubierta  | 2 | 70x19 | 4240 |
| CoB1 | Covering board- Deckbrett- Madrier de couverture- Tavola di copertura- Listón de cubierta  | 4 | 70x19 | 2940 |
| EaE9 | Eave edging- Dachrandbrett- Madrier en bordure du toit- Tavola bordo tetto- Tabla de valadizo  | 2 | 19x114 | 4240 |
| EaE8 | Eave edging- Dachrandbrett- Madrier en bordure du toit- Tavola bordo tetto- Tabla de valadizo  | 2 | 19x114 | 4240 |
| EaE4 | Eave edging- Dachrandbrett- Madrier en bordure du toit- Tavola bordo tetto- Tabla de valadizo  | 2 | 19x114 | 3295 |
| EaE2 | Eave edging- Dachrandbrett- Madrier en bordure du toit- Tavola bordo tetto- Tabla de valadizo  | 2 | 19x114 | 3295 |
| EaE1 | Eave edging- Dachrandbrett- Madrier en bordure du toit- Tavola bordo tetto- Tabla de valadizo  | 2 | 19x114 | 2685 |
| EaE5 | Eave edging- Dachrandbrett- Madrier en bordure du toit- Tavola bordo tetto- Tabla de valadizo  | 2 | 19x114 | 2685 |
| EaE7 | Eave edging- Dachrandbrett- Madrier en bordure du toit- Tavola bordo tetto- Tabla de valadizo  | 2 | 19x105 | 4240 |

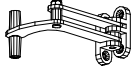
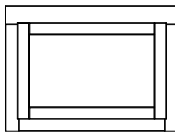

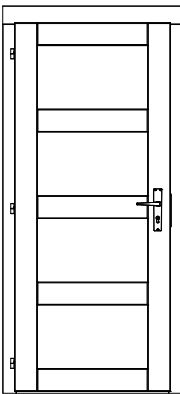
| Pos | SPECIFICATION-STÜCKLISTE-NOMENCLATURE-ELEMENTI-ESPECIFICACIÓN FRD44-3857 | Pcs | Profile (mm) | Length (mm) |
|---|--|------|---|----------------|
| EaE3 | Eave edging- Dachrandbrett- Madrier en bordure du toit- Tavola bordo tetto- Tabla de valadizo  | 2 | 19x105 | 3295 |
| EaE6 | Eave edging- Dachrandbrett- Madrier en bordure du toit- Tavola bordo tetto- Tabla de valadizo  | 2 | 19x105 | 2685 |
| RoR2 | Rafter- Sparre- Chevron- Trave- Cabrio  | 8 | 70x140 | 4007 |
| RoR1 | Rafter- Sparre- Chevron- Trave- Cabrio  | 8 | 44x120 | 240 |
| SP2 | Support brace- Stützleiste- Baguette de support- Listello di supporto- Listón de soporte  | 14 | 32x40 | 330 |
| SP3 | Support brace- Stützleiste- Baguette de support- Listello di supporto- Listón de soporte  | 12 | 32x40 | 300 |
| SP1 | Support brace- Stützleiste- Baguette de support- Listello di supporto- Listón de soporte  | 14 | 32x40 | 260 |
| RB2-1 | Roof board- Dachbrett- Madrier du toit- Tavola tetto- Tabla de tejado  | 45 | 89x19 | 3290 |
| RB2-2 | Roof board- Dachbrett- Madrier du toit- Tavola tetto- Tabla de tejado  | 45 | 89x19 | 2690 |
| StB1-1 | Storm brace- Sturmleiste- Protection contre le vent- Antivento- Protector contra tormentas  | 2 | 25x45 | 2220 |
| StB1-2 | Storm brace- Sturmleiste- Protection contre le vent- Antivento- Protector contra tormentas  | 2 | 25x45 | 2300 |
| Fim | -Fixing kit- Befestigungsset- Moyens de fixation- Materiale di fissaggio- Kit de fijación  | 1 | USE | |
| QKSP0 6x18Zn | Bolt -Schloss-schraube -Boulon- Bullone- Perno- M6x18mm KSP0  | 8 |  +  | |
| QPUP 06x60 | Bolt -Schloss-schraube -Boulon- Bullone- Perno- M6x60mm PUP0  | 8 |  + Wall B | |
| QPUP 08x80 | Bolt -Schloss-schraube -Boulon- Bullone- Perno- M8x80mm PUP0  | 8 | StB1-x+ Wall | |
| QULSy damik 30/35 | Cylinder- Zylinderschloss- Serrure a mortaiser- Serratura a cilindro- Bombin- 30.35  | 1 | U44-15L | |
| KULEN GP-37 | Detail- Detail- Detail- Dettaglio- Detalle- KULENGP-37  | 1 | Wall2 | |
| KULEN GV-37 | Detail- Detail- Detail- Dettaglio- Detalle- KULENGV-37  | 1 | Wall2 | |
| KULEN GY-25 | Detail- Detail- Detail- Dettaglio- Detalle- KULENGY-25  | 1 | Wall2 | |
| QULKat eHOBEk | Door fittings- Türbeschlag- Ferrure- Ferramenta porta- Manilla puerta- QULKateHOBEk  | 1 | U44-15L | |
| QULLi nkHOBE | Door fittings- Türbeschlag- Ferrure- Ferramenta porta- Manilla puerta- QULLinkHOBE  | 1 | U44-15L | |
| QNU2 02040 | L-iron- Winkel- Angle -Angolo- Angulo 20x20x40  | 2 | 002 (W2) | |
| QNU4 04040 | L-iron- Winkel- Angle -Angolo- Angulo 40x40x40  | 32 | ARx+Wall (16) RoR2+Wall (16) | |
| QNU22 015030 | L-iron- Winkel- Angle -Angolo- Angulo 220x150x30  | 8 | SP2+WallB | |
| QNA3 x70ZN | Nail- Nagel- Clou- Chiodo- Clavo- 3x70mm  | 1000 | RB2-x + RoR2 RB2-x + 012/013 | |
|  | Object name FRD44-3857 | Page | | 2/3 |

| Pos | SPECIFICATION-STÜCKLISTE-NOMENCLATURE-ELEMENTI-ESPECIFICACIÓN FRD44-3857 | | Pcs |
|----------------|---|---|--|
| QMU6 | Nut- Schraubenmutter- Écrou- Dado- Tuerca- M6mm |  | 16  |
| QMU8 | Nut- Schraubenmutter- Écrou- Dado- Tuerca- M8mm |  | 8  |
| QKR4 5x40ZN | Screw- Schraube- Vis- Vite- Tornillo- 4.5x40mm |  | 300  |
| QKR4 5x50ZN | Screw- Schraube- Vis- Vite- Tornillo- 4.5x50mm |  | 350 EaEx; CoBx; ... |
| QKR4 5x70ZN | Screw- Schraube- Vis- Vite- Tornillo- 4.5x70mm |  | 10 001; 005; 012 |
| QKR5 x90ZN | Screw- Schraube- Vis- Vite- Tornillo- 5x90mm |  | 100 012/013+RoR2 SP1&3+RoR2 KULENGY-25 |
| QKR6x 120ZN | Screw- Schraube- Vis- Vite- Tornillo- 6x120mm |  | 36 ARx 8pcs Wall+RoR1 16pcs Wall+SP3 12pcs |
| QSE6x18 | Washer- Dichtscheibe- Joint- Rondella- Arandela- 6x18mm |  | 24  16pcs 8pcs |
| QSE8x22 | Washer- Dichtscheibe- Joint- Rondella- Arandela- 8x22mm |  | 8  |
| QALp ainP | Window fittings- Fenstergriff- Poigne de la fenêtre- Maniglia finestra- Manilla- QALpainP |  | 2 A44-21Y |
| QAF140 | Window stop- Fensterfeststelle- Crémaillere- Fissativo finestra- Fijador de ventana- QAF140 |  | 2 A44-21Y |
| A44-21Y | Window - Fenster - Fenetre - Finestra-Ventana 800x534  700x434mm |  | 2 |
| U44-15L | Door - Tür - Porte - Porta-Puerta 835x1900  735x1831mm |  | 1 |
| | | | |
| | | | |
| | | | |
| | | | |
| | | | |

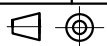

Foundation- Fundament- Fondation- Fondazione- Vigas de cimentación

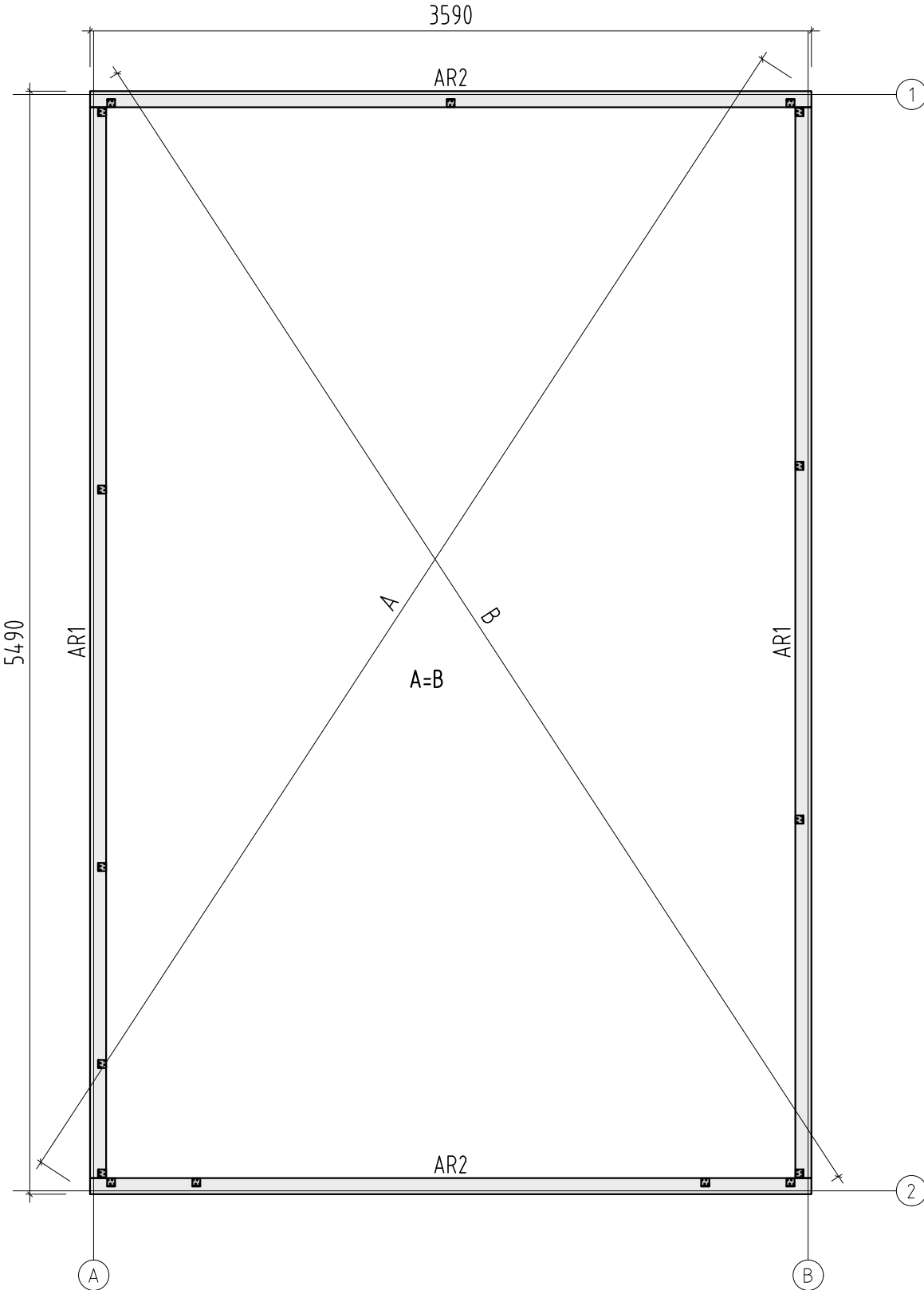

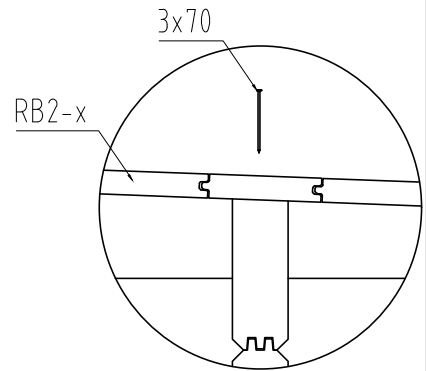
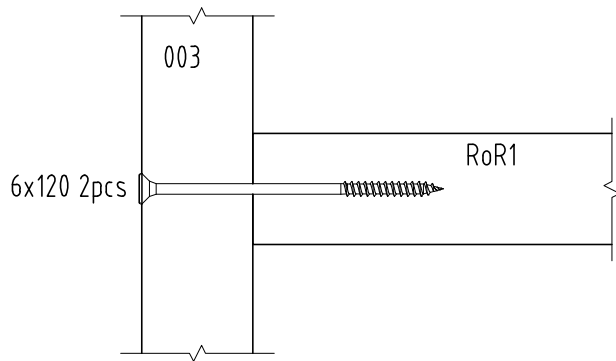
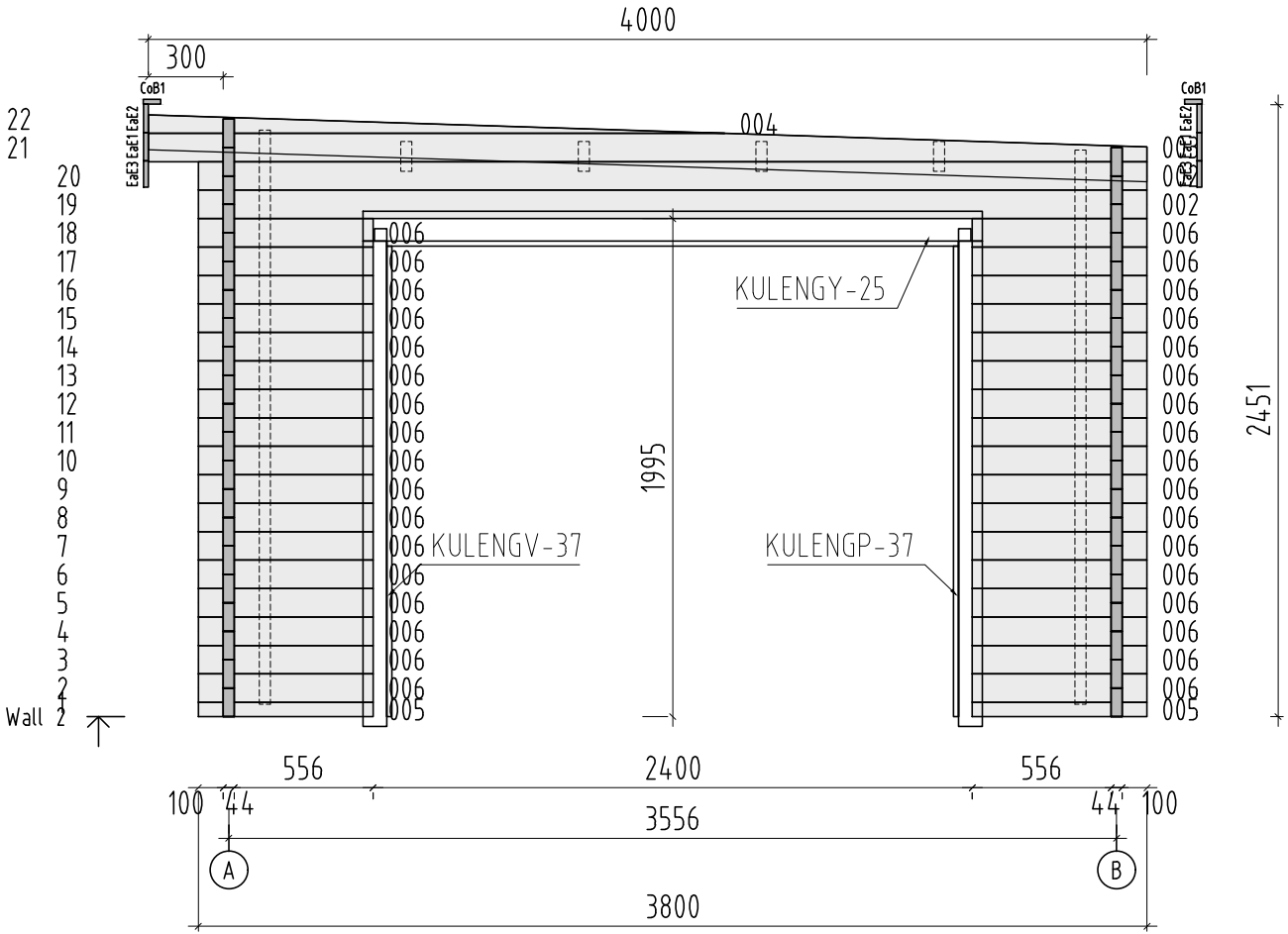
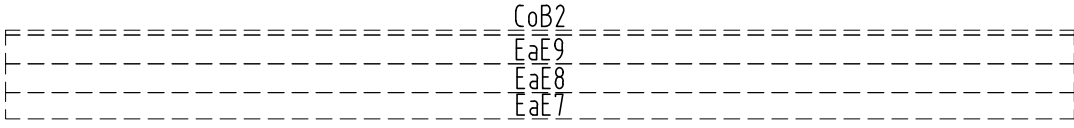

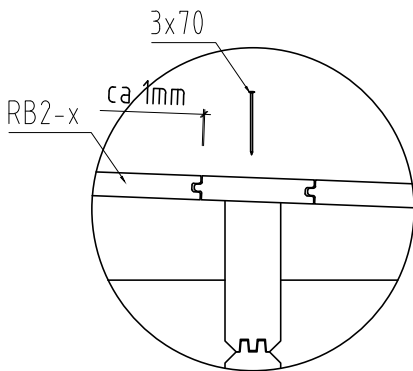
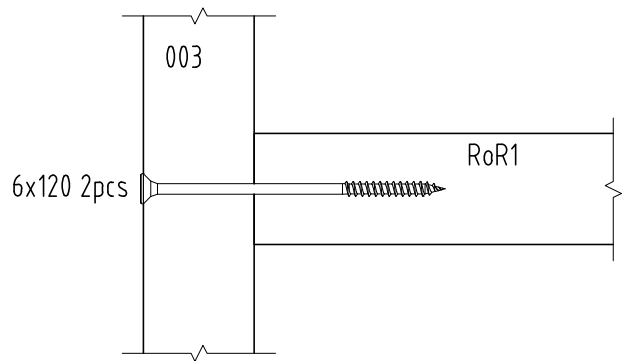
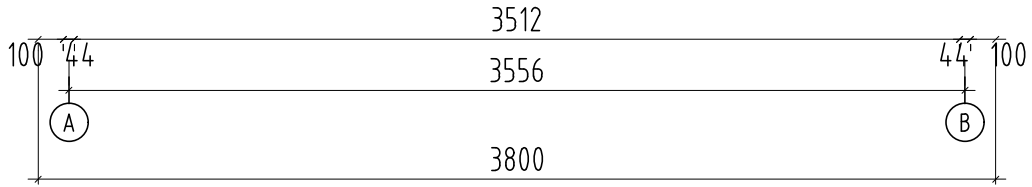
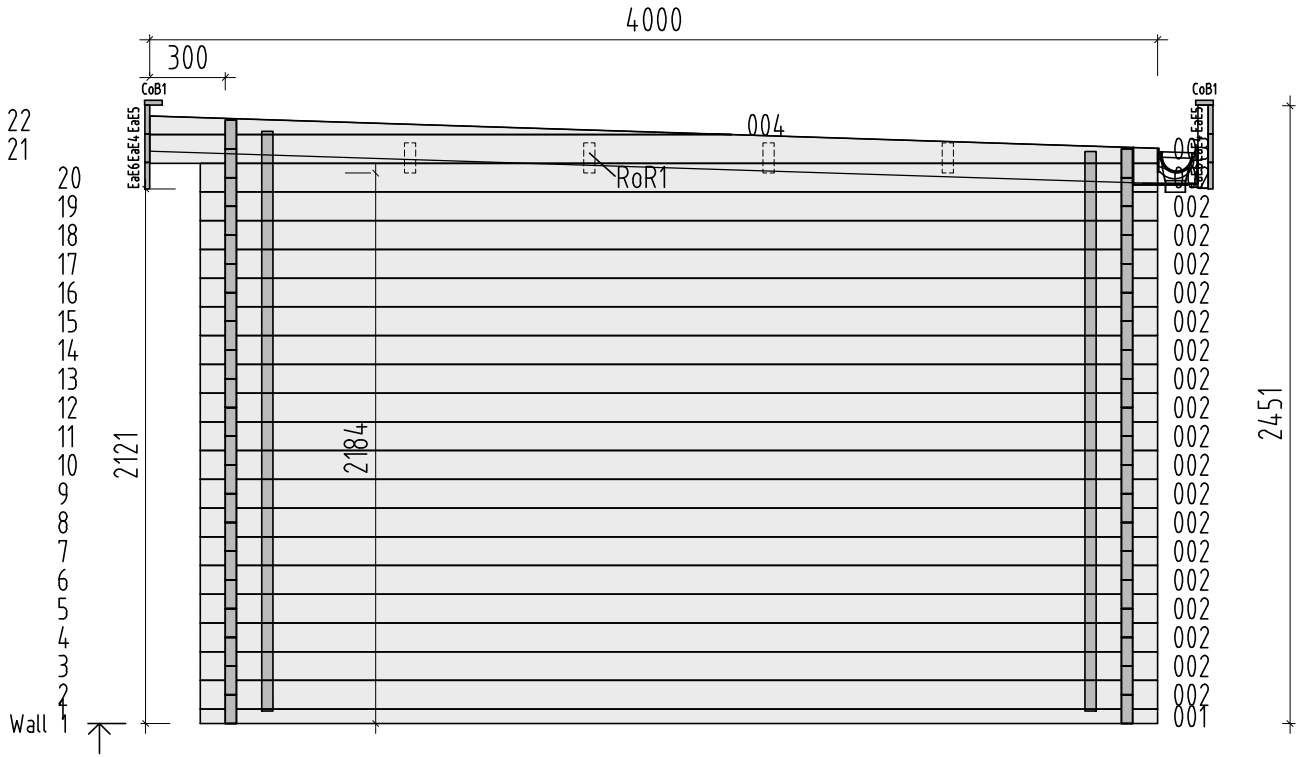
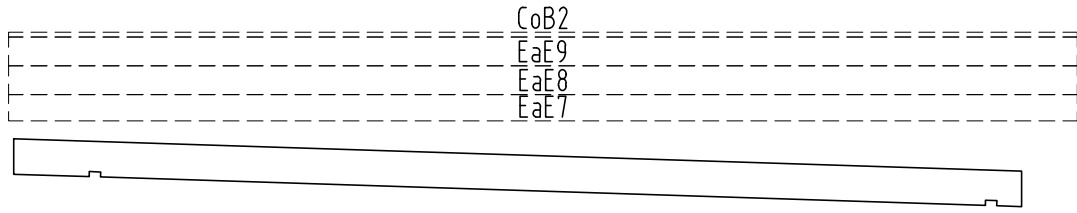

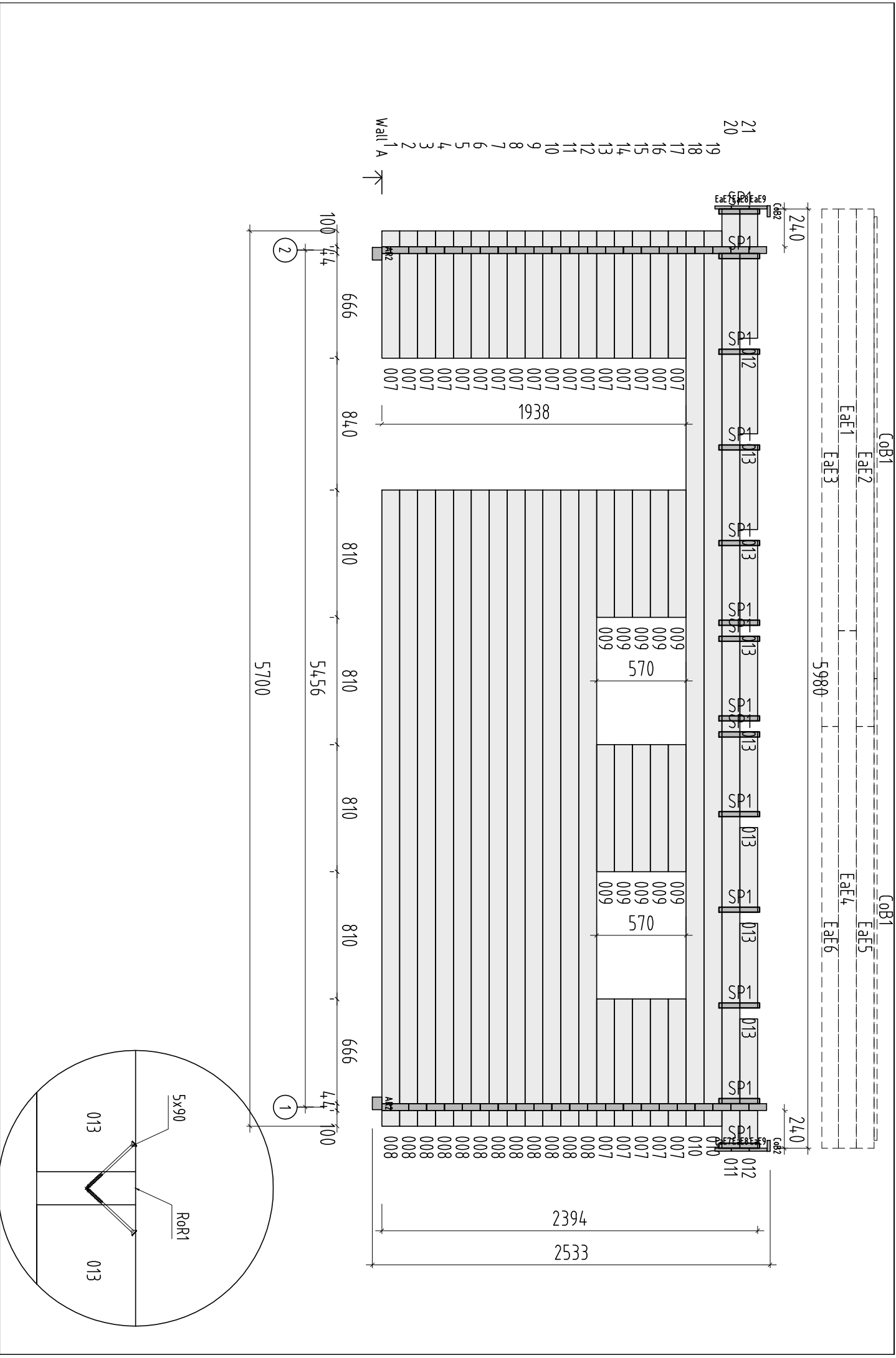

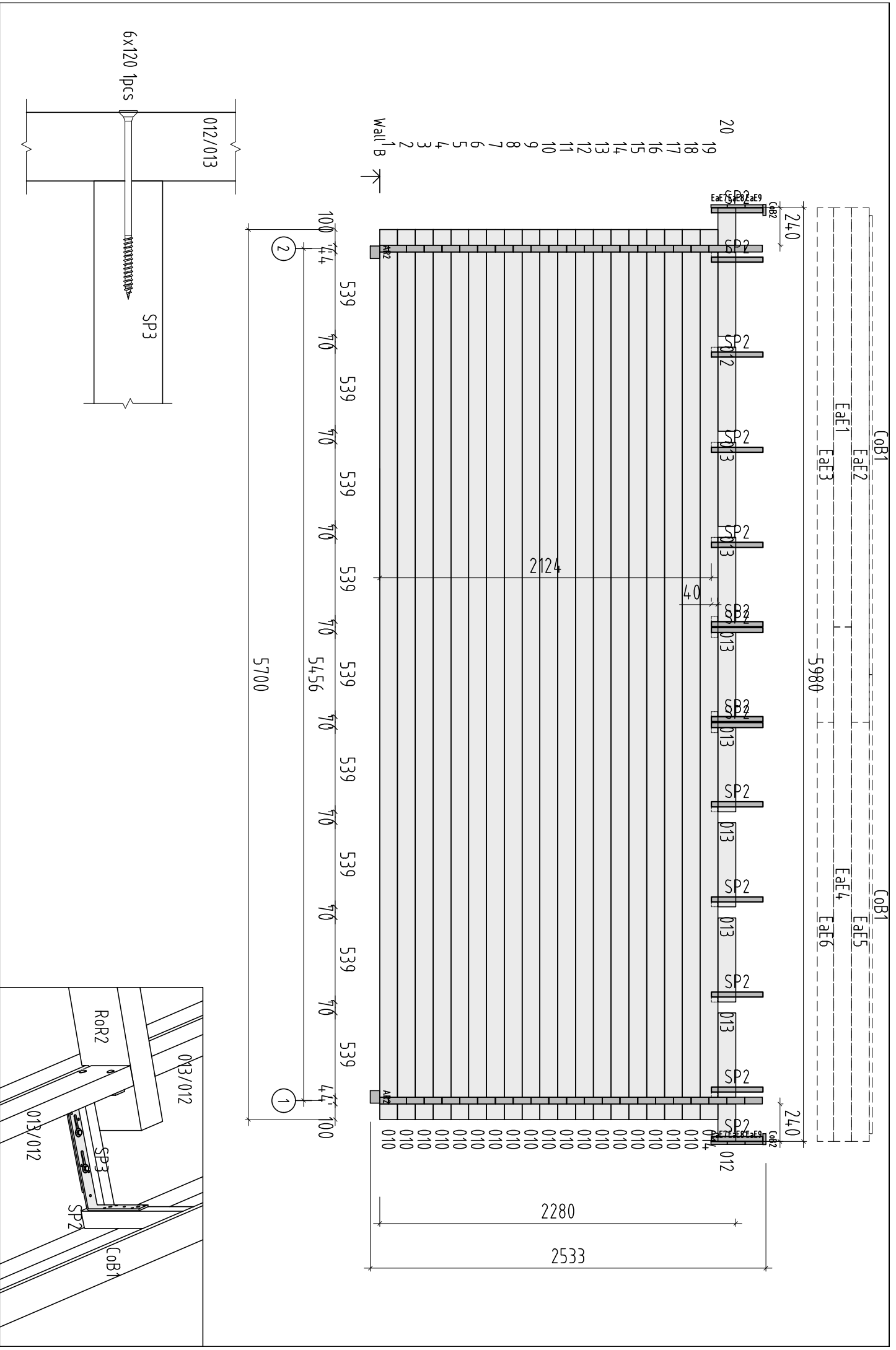

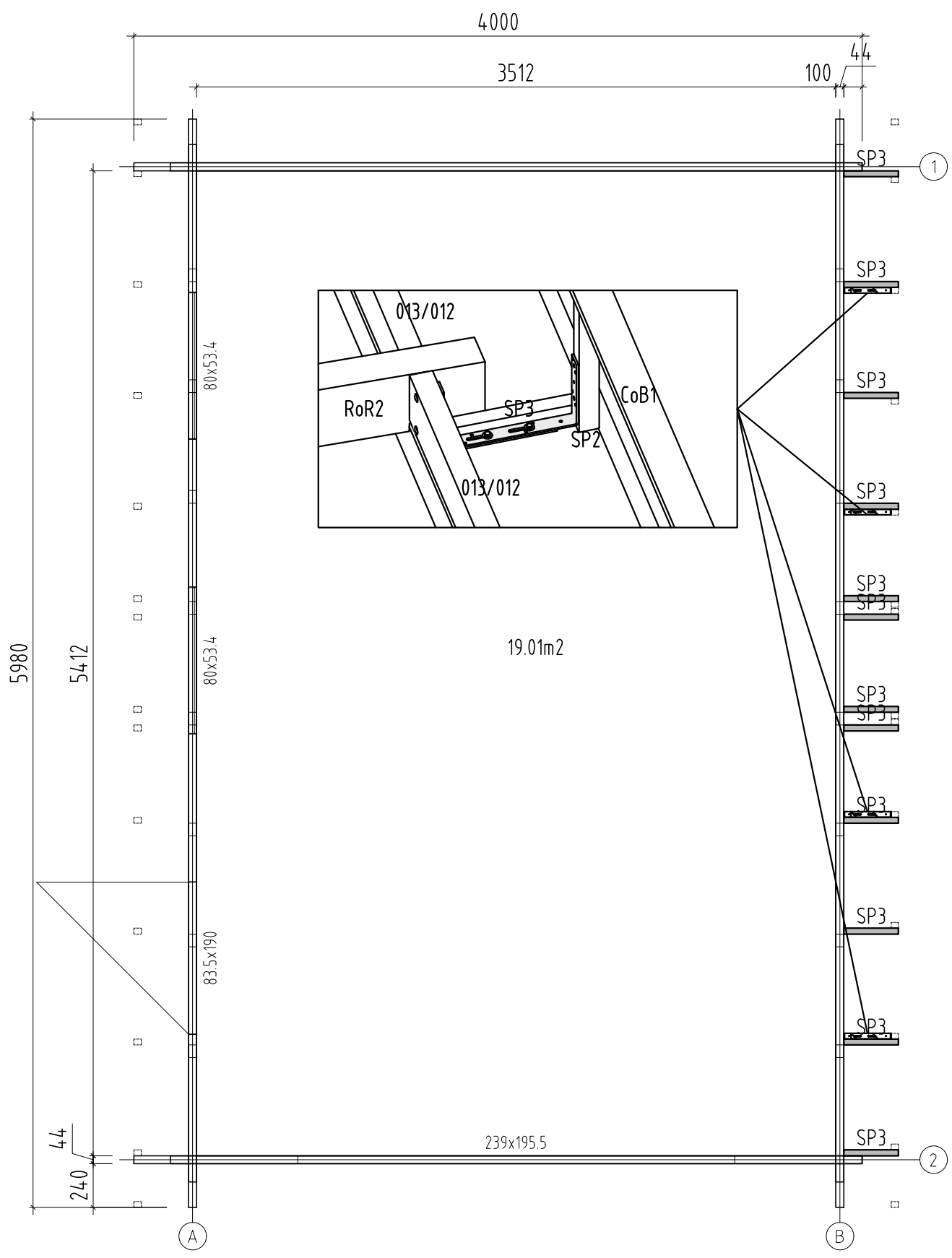

Rafter- Sparre- Chevron- Trave- Cabrio

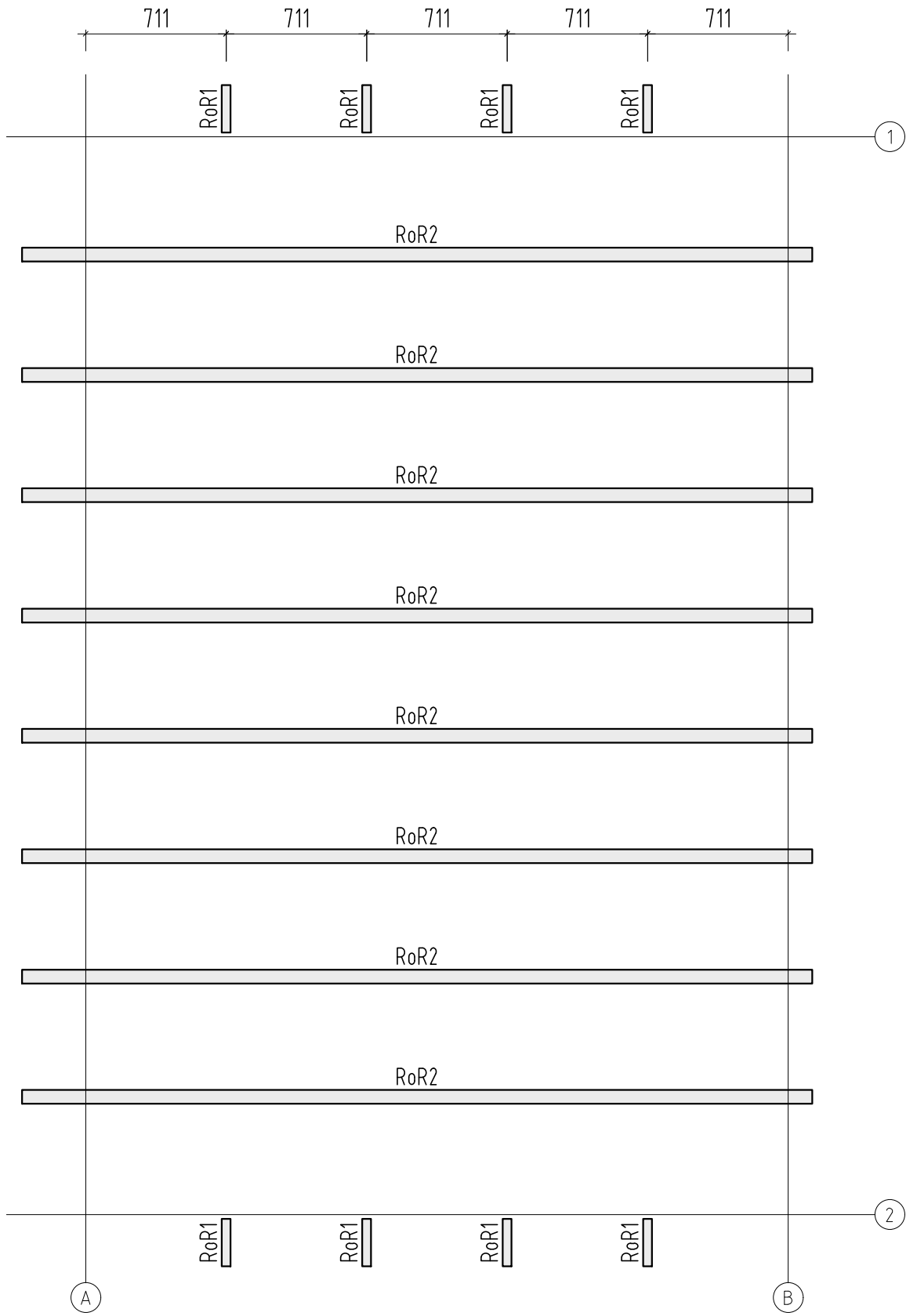

Roof board- Dachbrett- Madrier du toit- Tavola tetto- Tabla de tejado

→ Space between boards $\approx 1\text{mm}$

