







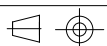

Pos	SPECIFICATION-STÜCKLISTE-NOMENCLATURE-ELEMENTI-ESPECIFICACIÓN LAZFB16-2719	Pcs	Profile (mm)	Length (mm)
AR1	Foundation- Fundament- Fondation- Fondazione- Vigas de cimentación 	9	32x40	1864
AR2	Foundation- Fundament- Fondation- Fondazione- Vigas de cimentación 	7	32x40	772
AR3	Foundation- Fundament- Fondation- Fondazione- Vigas de cimentación 	3	32x40	400
FB1-1	Floor board- Fussbodenbrett- Madrier du plancher - Tavola pavimento- Tabla de suelo 	30	89x16	1794
FLB2-1	Floor beading- Fussbodenleiste- Baguette du plancher- Listello pavimento- Listón de suelo 	5	19x19	1820
Fim	-Fixing kit- Befestigungsset- Moyens de fixation- Materiale di fissaggio- Kit de fijación 	1		
QNA1 4x40M	Nail- Nagel- Clou- Chiodo- Clavo- 1.4x40mm 	25		
QNA2 2x50Zn	Nail- Nagel- Clou- Chiodo- Clavo- 2.5x50mm 	150		
QKR4 5x60Zn	Screw- Schraube- Vis- Vite- Tornillo- 4.5x60mm 	35		

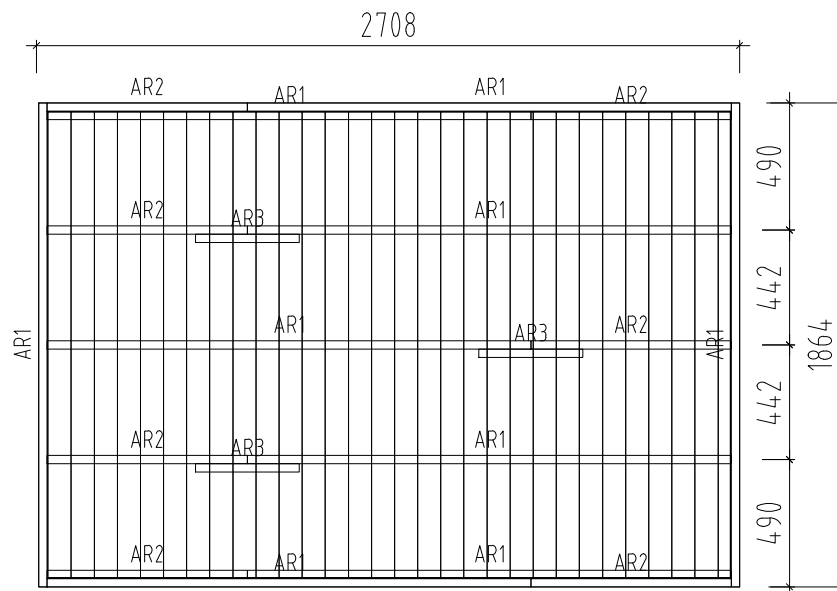
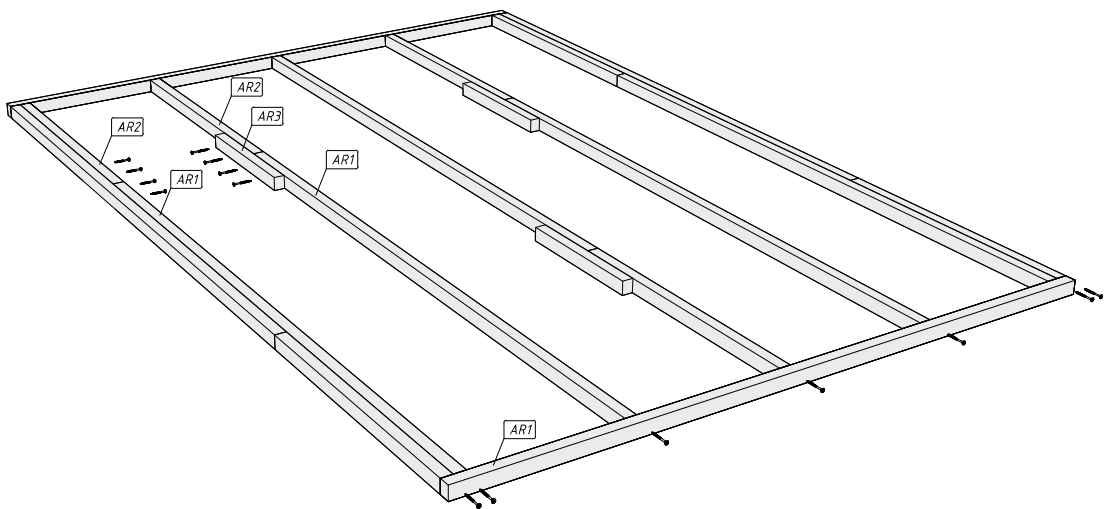

Object name