

Installation manual

Montageanleitung • Notice de montage • Istruzioni per il montaggio

Manual de montaje • Monteringsanvisning • Installatiegids

ROGER 28,4 m²

Log cabin FRE44-5953

Blockhaus • Maisonnette en poutres • Casa di travi • Casa de jardin • Anneks • Tuinhuis

Width 595 x Depth 530 cm







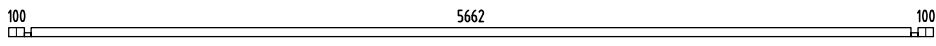
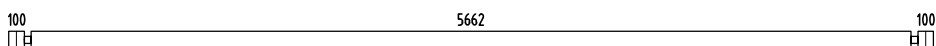

Breite/Tiefe • Largeur/Profondeur • Lunghezza/Profondità • Ancho/Profundidad • Bredde/Dybde • Breedte/Diepte

Log thickness 44 mm



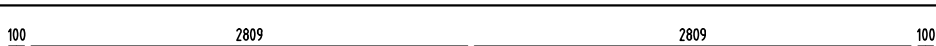
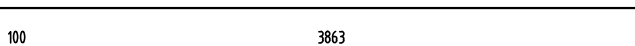

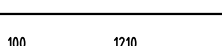
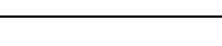
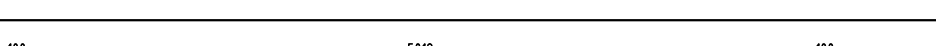
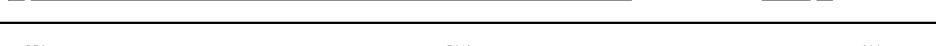
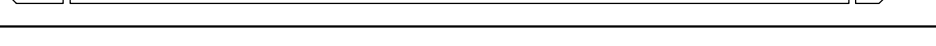

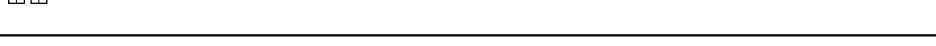
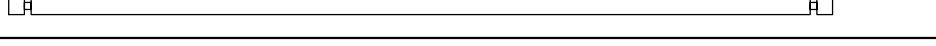
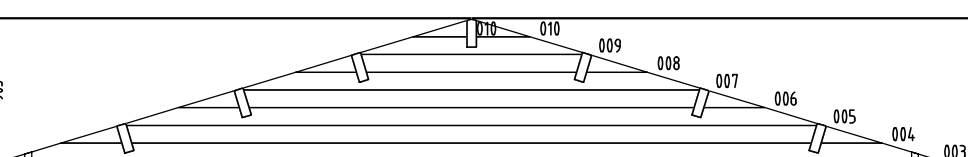
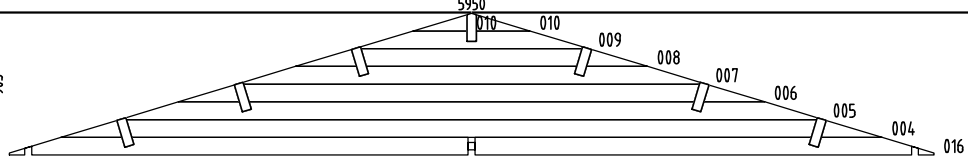
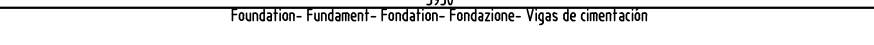
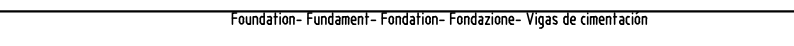
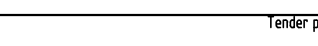

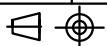

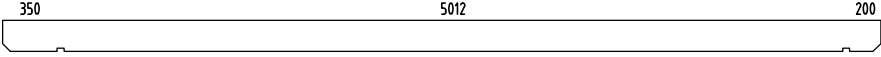
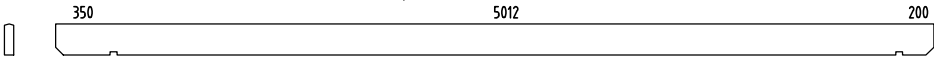







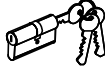

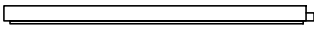
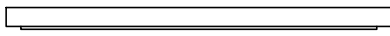
Bohlenstärke • Épaisseur des murs • Spessore delle pareti • Grosor de pared • Tykkelse • Wanddikte





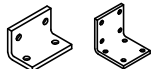





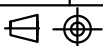

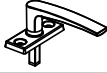
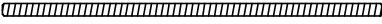

The producer shall have the right to make technical changes to the product • Technische Änderungen vorbehalten • Le producteur réserve le droit d'effectuer des modifications techniques au produit • Il produttore mantiene il diritto di apportare modifiche tecniche al prodotto • Reservado el derecho a modificaciones técnicas • Produsent forbeholder seg retten til å endre tekniske egenskaper ved produktet • Alle rechten en technische wijzigingen voorbehouden

Pos	SPECIFICATION-STÜCKLISTE-NOMENCLATURE-ELEMENTI-ESPECIFICACIÓN "FRE44-5953"	Pcs	Profile (mm)	Length (mm)
001		1	44x57	5950
002		18	44x114	5950
011		2	44x57	403
012		1	44x57	344
013		34	44x114	403
014		17	44x114	344
015		1	44x114	5950
017		7	44x114	4007
018		16	44x114	453
019		9	44x114	1354
020		9	44x114	1354
021		1	44x114	5300
022		2	44x114	5650
023		1	44x114	5650
024		19	44x114	244
025		1	44x57	244
026		17	44x114	5300
027		1	44x114	5650
W1-1		1		
W2-1		1		
AR2	 Foundation- Fundament- Fondation- Fondazione- Vigas de cimentación	2	80x60	5580
AR1	 Foundation- Fundament- Fondation- Fondazione- Vigas de cimentación	2	80x60	5090
TP1	 Tender post- Tenderleiste- T-poste- Rinforzo- Refuerzo	4	19x19	1940

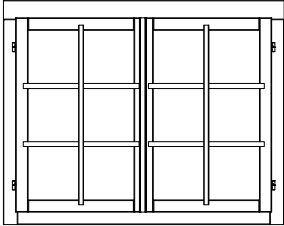

Pos	SPECIFICATION-STÜCKLISTE-NOMENCLATURE-ELEMENTI-ESPECIFICACIÓN "FRE44-5953"	Pcs	Profile (mm)	Length (mm)
PR1	Purlin- Dachpfette- Arbalétrier- Arcareccio- Correa 5012 	6	60x200	5650
PR2	Purlin- Dachpfette- Arbalétrier- Arcareccio- Correa 5012 	1	60x200	5650
RB2-1	Roof board- Dachbrett- Madrier du toit- Tavola tetto- Tabla de tejado 	128	89x19	3260
Dia-1	Diamond- Deckbrett- Madrier- Tavola di copertura- Rombo 	2	19x140	300
EaE1-1	Eave edging- Dachrandbrett- Madrier en bordure du toit- Tavola bordo tetto- Tabla de valadizo 	4	16x95	2825
FaB3-1	Facia board- Giebelblende- Écran frontal- Schermo frontone- Tabla de facia 	4	16x120	3300
RE2-1	Roof edge reinforcement- Dachrandleiste- Baguette en bordure du toit- Rinforzo bordo tetto- Refuerzo borde tejado 	2	32x40	2400
RE2-2	Roof edge reinforcement- Dachrandleiste- Baguette en bordure du toit- Rinforzo bordo tetto- Refuerzo borde tejado 	2	32x40	3250
QTihe ndTPE 8mm-1	Seal- Gummidichtung- Joint d'isolation- Guarnizione- Burlete 	2	U44-24L; TA44-21L	5000
Fim	-Fixing kit- Befestigungsset- Moyens de fixation- Materiale di fissaggio- Kit de fijación 	1	USE	
QULSy damik 30/35	Cylinder- Zylinderschloss- Serrure a mortaiser- Serratura a cilindro- Bombin- 30.35 	1	U44-24L	
KULEN GP-37	Detail- Detail- Detail- Dettaglio- Detalle- KULENGP-37 	2		
KULEN GV-37	Detail- Detail- Detail- Dettaglio- Detalle- KULENGV-37 	2		
KULEN GY-25	Detail- Detail- Detail- Dettaglio- Detalle- KULENGY-25 	2		
QULKat eHOBEk	Door fittings- Türbeschlag- Ferrure- Ferramenta porta- Manilla puerta- QULKateHOBEk 	1	U44-24L	
QULli nkHOBE	Door fittings- Türbeschlag- Ferrure- Ferramenta porta- Manilla puerta- QULlinkHOBE 	1	U44-24L	
QNU2 02040	L-iron- Winkel- Angle -Angolo- Angulo 20x20x40 	4		
QNU4 04040	L-iron- Winkel- Angle -Angolo- Angulo 40x40x40 	15	AR+wall; ...	
QNA2 2x50Zn	Nail- Nagel- Clou- Chiodo- Clavo- 2.5x50mm 	800	RB2-1	
QKR3 5x40Zn	Screw- Schraube- Vis- Vite- Tornillo- 3.5x40mm 	130		
QKR3 x20Zn	Screw- Schraube- Vis- Vite- Tornillo- 3x20mm 	18	U44-24L; TA44-21L	
QKR4 5x50Zn	Screw- Schraube- Vis- Vite- Tornillo- 4.5x50mm 	110	KULENGx+KULENGY-25 EaE1-1; FaB3-1; RE2-1;	
QKR4 5x70Zn	Screw- Schraube- Vis- Vite- Tornillo- 4.5x70mm 	60	001; 011; 012; 023; 027	
QKR5 x90Zn	Screw- Schraube- Vis- Vite- Tornillo- 5x90mm 	8	KULENGY-25	

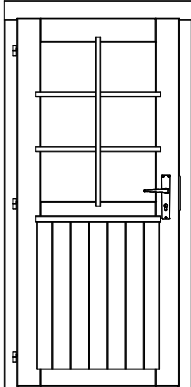

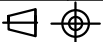
Pos	SPECIFICATION-STÜCKLISTE-NOMENCLATURE-ELEMENTI-ESPECIFICACIÓN "FRE44-5953"	Pcs	Profile (mm)	Length (mm)
QKR6x 120ZN	Screw- Schraube- Vis- Vite- Tornillo- 6x120mm 	18	ARx; PRx	
QALi nkHOBE	Window fittings- Fenstergriff- Poigne de la fenêtre- Maniglia finestra- Manilla (ventana) 	1	TA44-21L	
KL1	Threaded rod- Gewindestangen- Barre fileté- Asta filettata- Varilla roscada M8 	6		2000
KL2	Threaded rod- Gewindestangen- Barre fileté- Asta filettata- Varilla roscada M8 	6		270
	Nut- Schraubenmutter- Écrou- Dado- Tuerca- M8mm 	6		
	Washer- Dichtscheibe- Joint- Rondella- Arandela- 8x22mm 	6		
	Extension nut- Verlängerungsmutter- Écrou rallonge- Dado di prolunga- Tuerca de extensión- JM8 	6		
	Captive nut- Einschlagmutter- Écrou a griffes- Dado a ragno filettatura- Tuerca arana- LM8 	6		
TA44 -21L	Window - Fenster - Fenetre - Finestra-Ventana 1290x990   1190x890mm	1		
U44-24L	Door - Tür - Porte - Porta-Puerta 835x1822   735x1753mm	1		
	Object name "FRE44-5953"		Page	3/3

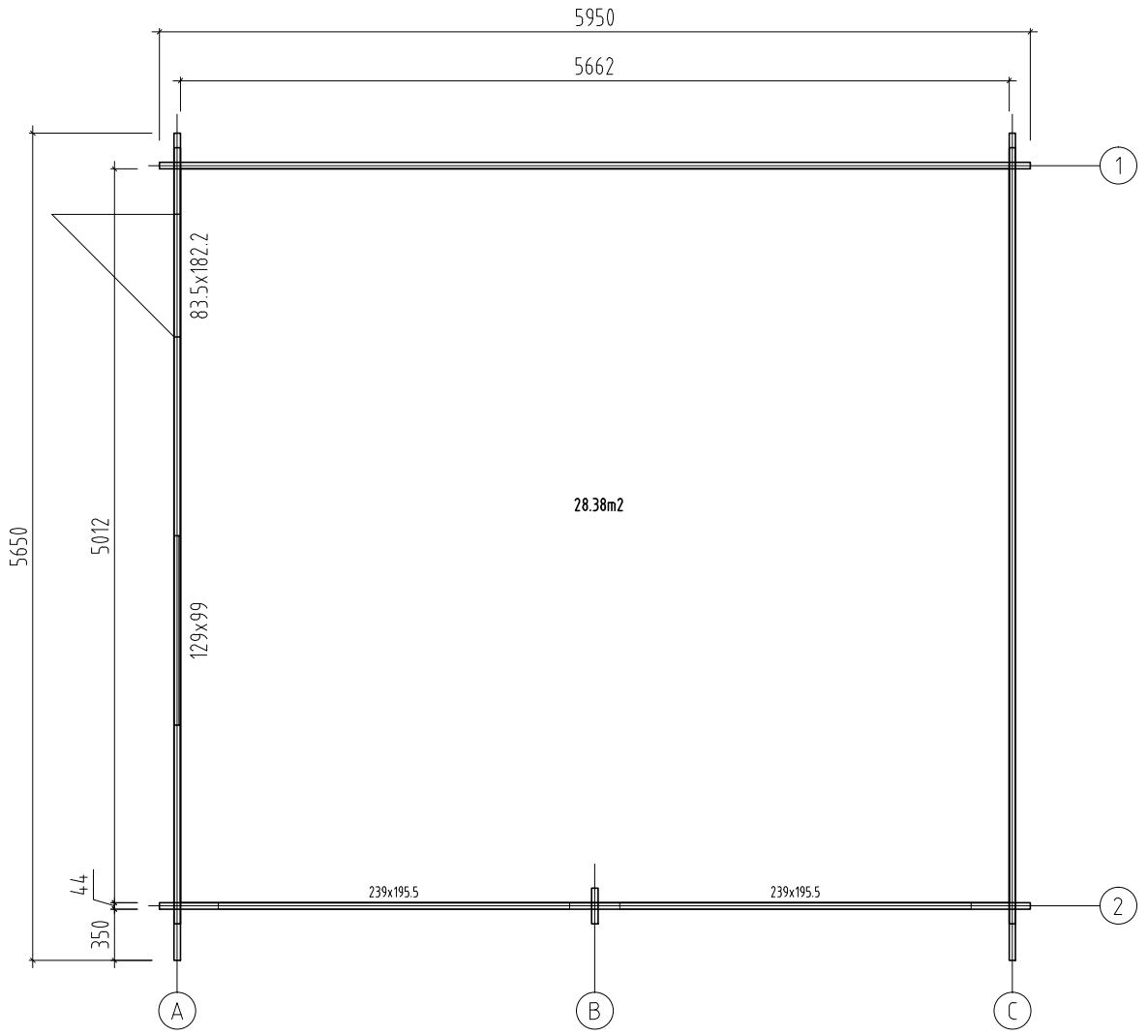

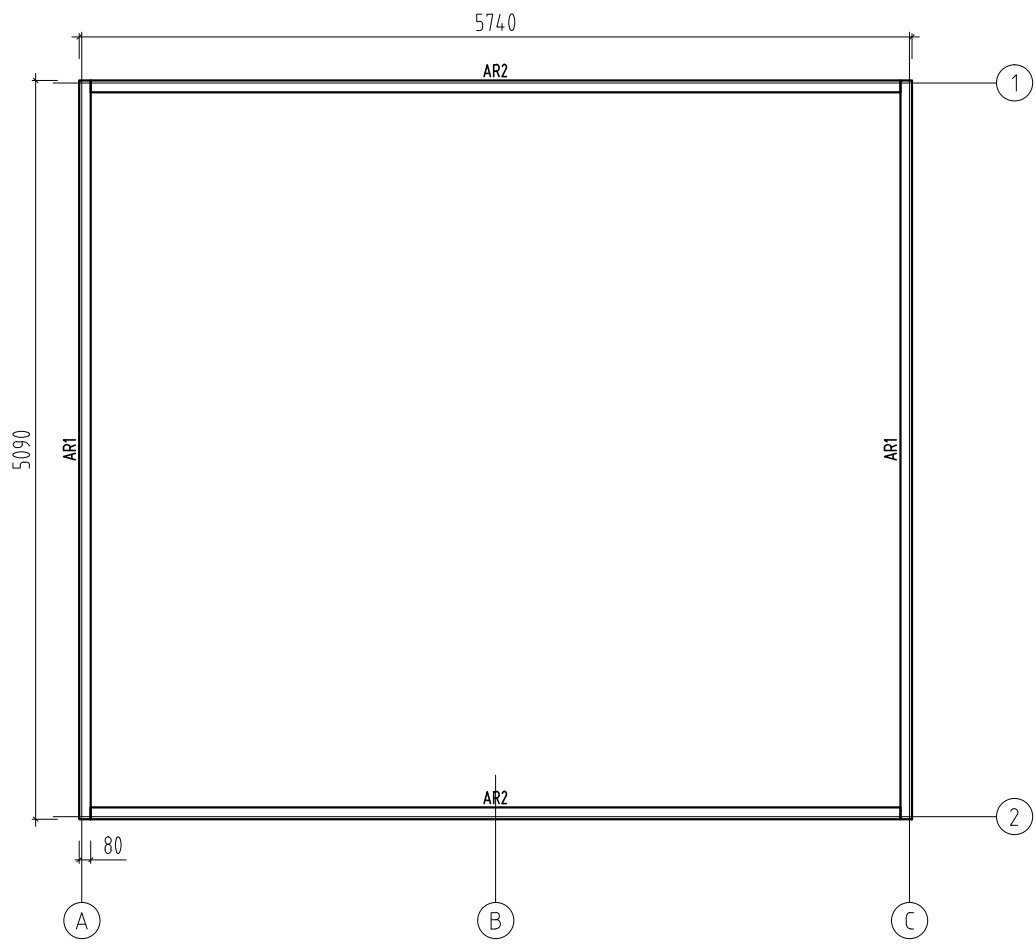

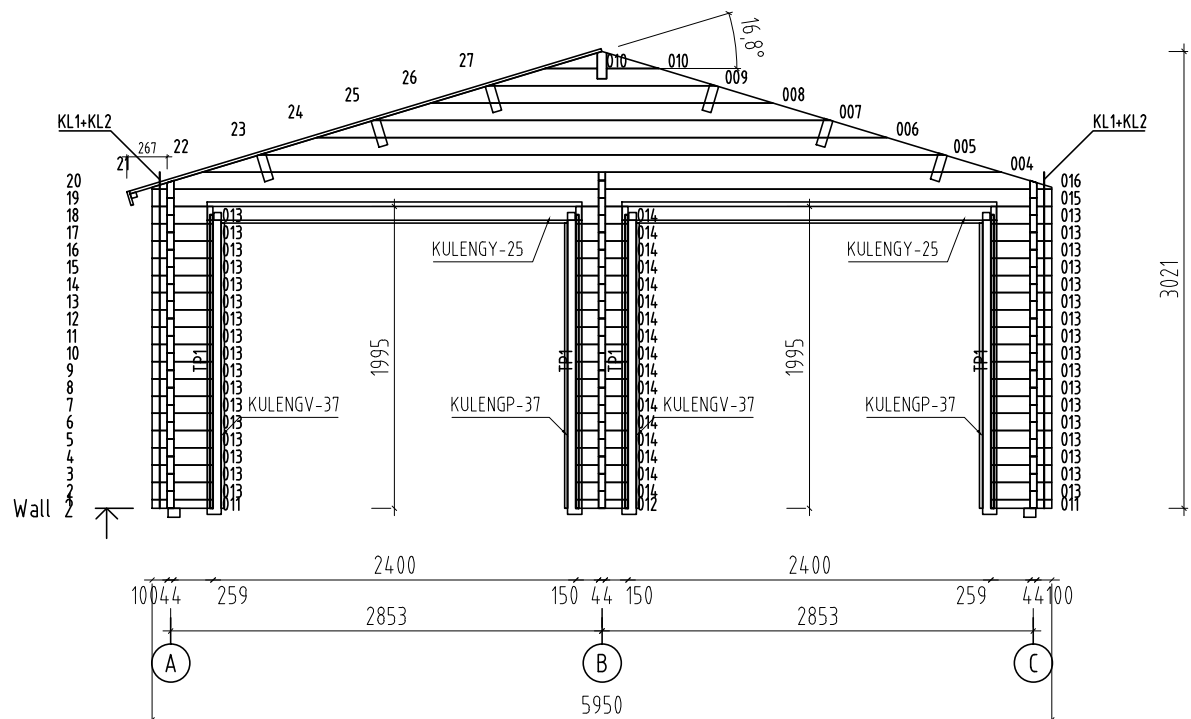

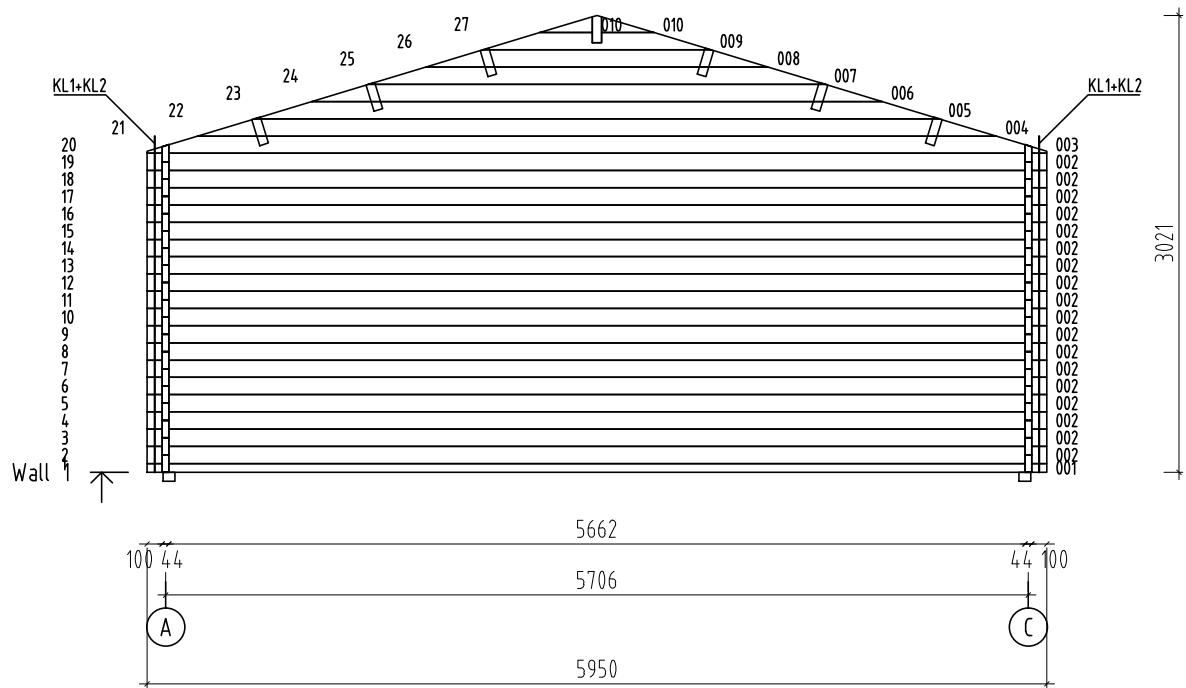

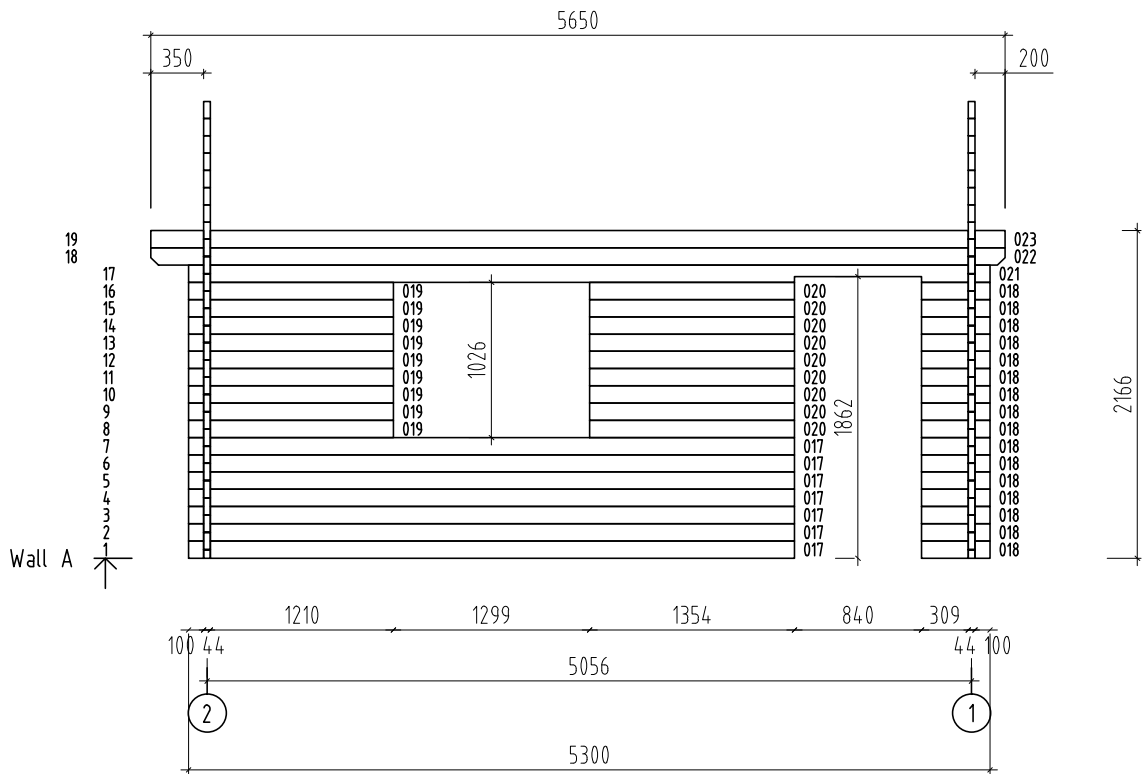

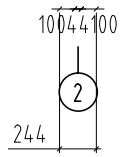
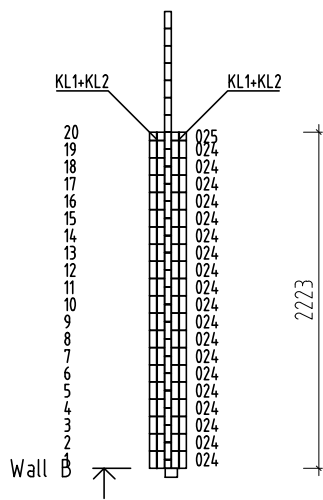

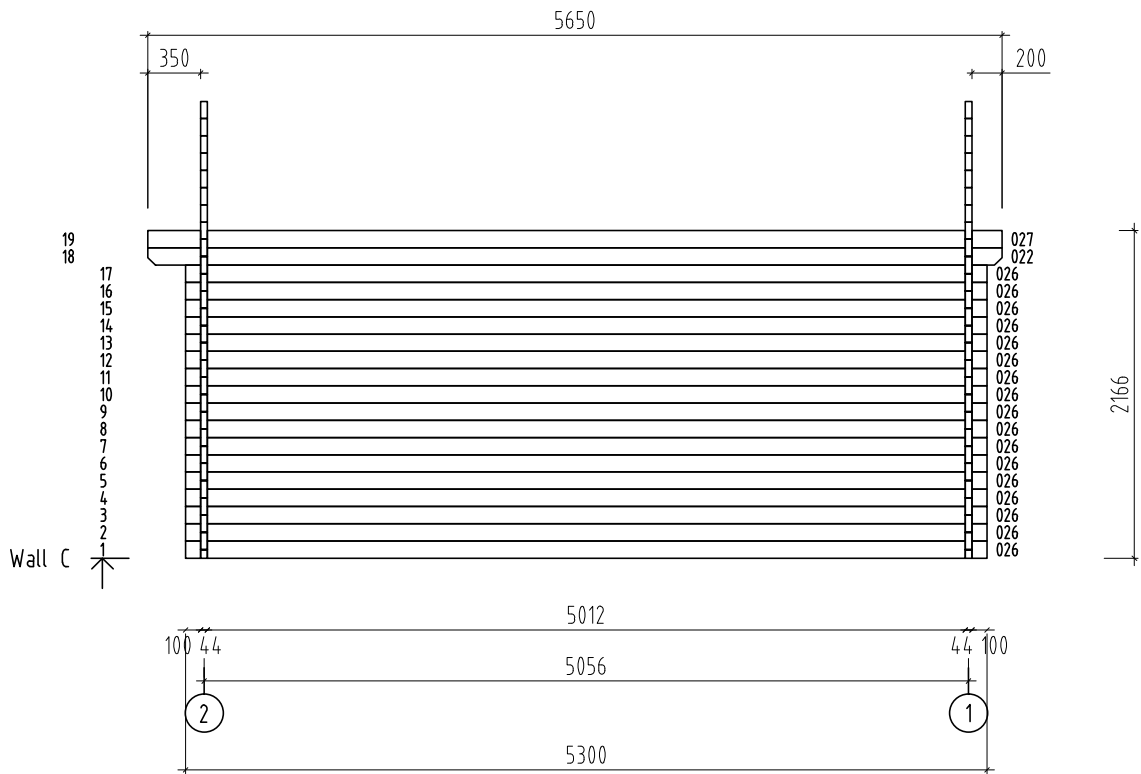

GARAGE

