

Installation manual

Montageanleitung • Notice de montage • Istruzioni per il montaggio
Manual de montaje • Monteringsanvisning • Installatiegids

Log cabin PAJ44-3535

Blockhaus • Maisonnette en poutres • Casa di travi • Casa de jardin • Anneks • Tuinhuis

Width 350 x Depth 350 cm











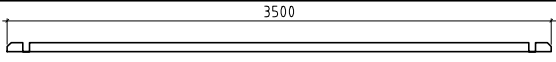
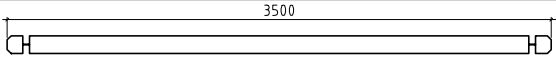
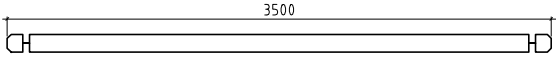
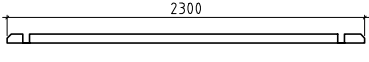
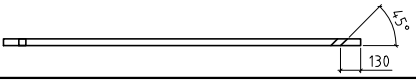
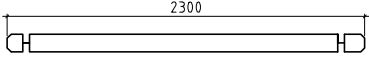
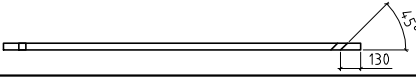

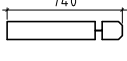
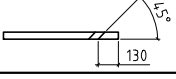

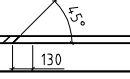
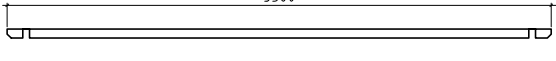
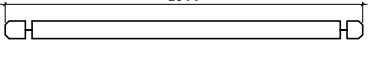
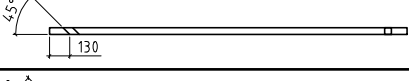
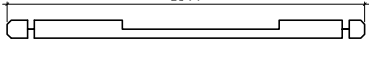
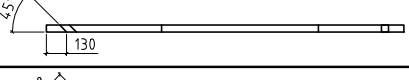
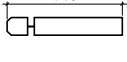
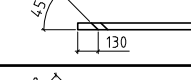
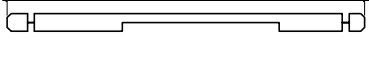
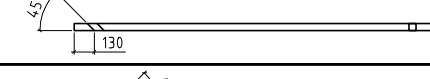

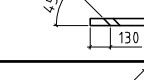
Breite/Tiefe • Largeur/Profondeur • Lunghezza/Profondità • Ancho/Profundidad • Bredder/Dybde • Breedte/Diepte

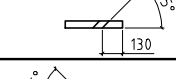
Log thickness 44 mm

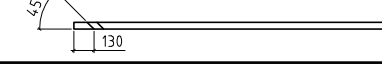
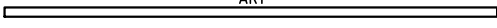
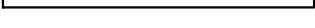



Bohlenstärke • Épaisseur des murs • Spessore delle pareti • Grosor de pared • Tykkelse • Wanddikte





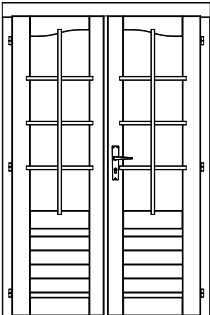

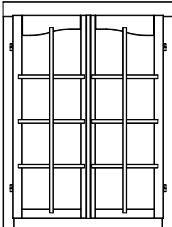





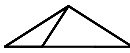



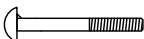
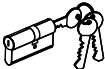







The producer shall have the right to make technical changes to the product • Technische Änderungen vorbehalten • Le producteur réserve le droit d'effectuer des modifications techniques au produit • Il produttore mantiene il diritto di apportare modifiche tecniche al prodotto • Reservado el derecho a modificaciones técnicas • Produsent forbeholder seg retten til å endre tekniske egenskaper ved produktet • Alle rechten en technische wijzigingen voorbehouden

Pos	SPECIFICATION-STÜCKLISTE-NOMENCLATURE-ELEMENTI-ESPECIFICACIÓN "PAJ44-3535"	Pcs	Profile (mm)	Length (mm)
001		1	44x57	3500
002		42	44x114	3500
003	 Without tonque	2	44x114	3500
004	 	1	44x57	2300
005	 	5	44x114	2300
006		23	44x114	550
007	 	12	44x114	740
008	 	1	44x114	3500
009		2	44x57	3500
010	 	5	44x114	2300
011	 	1	44x114	2300
012	 	11	44x114	740
013	 	1	44x114	2300
014		1	44x57	375
015	 	17	44x114	375
016	 	17	44x114	375
017	 	1	44x114	2000
AR1		4	60x80	3170
AR2		1	60x80	2003
AR3		1	60x80	3290
AR4		1	60x80	2063
AR5		1	60x80	2590
AR6		1	60x80	1735
130	Floor beading- Fussbodenleiste- Baguette du plancher- Listello pavimento- Listón de suelo 	2	19x19	3250
131	Floor beading- Fussbodenleiste- Baguette du plancher- Listello pavimento- Listón de suelo 	3	19x19	2050
Code	"PAJ44-3535"	Page		1/4

Pos	SPECIFICATION-STÜCKLISTE-NOMENCLATURE-ELEMENTI-ESPECIFICACIÓN "PAJ44-3535"	Pcs	Profile (mm)	Length (mm)
060	Floor board- Fussbodenbrett- Madrier du plancher - Tavola pavimento- Tabla de suelo	23	89x19	3205
061		1	89x19	3205
062		1	89x19	3116
063		1	89x19	3027
064		1	89x19	2938
065		1	89x19	2849
066		1	89x19	2760
067		1	89x19	2671
068		1	89x19	2582
069		1	89x19	2493
0610		1	89x19	2404
0611		1	89x19	2315
0612		1	89x19	2226
0613		1	89x19	2137
0614		1	89x19	2048
160	Rafter- Sparre- Chevron- Trave- Cabrio	4	44x120	2962
161	Rafter- Sparre- Chevron- Trave- Cabrio	4	44x120	1870
162	Rafter- Sparre- Chevron- Trave- Cabrio	4	44x120	1153
163	Rafter- Sparre- Chevron- Trave- Cabrio	4	44x120	1870
164	Rafter- Sparre- Chevron- Trave- Cabrio	4	44x120	1153
165	Detail- Detail- Detail- Dettaglio- Detalle	12	70x135	607
166	Detail- Detail- Detail- Dettaglio- Detalle	4	70x135	607
167	Detail- Detail- Detail- Dettaglio- Detalle	4	70x135	607
168	Central fixing block- Dachspitzenbefestigungsholz- Bloc de fixation au sommet de toit- Bloque fijador de tejado	1	70x70	200
140	Storm brace- Sturmleiste- Protection contre le vent- Antivento- Protector contra tormentas	5	25x45	2220
Code	"PAJ44-3535"	Page		2/4

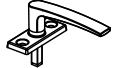
Pos	SPECIFICATION-STÜCKLISTE-NOMENCLATURE-ELEMENTI-ESPECIFICACIÓN "PAJ44-3535"	Pcs	Profile (mm)	Length (mm)
070	Roof board- Dachbrett- Madrier du toit- Tavola tetto- Tabla de tejado 		114x19	
071		4	114x19	262
072		4	114x19	470
073		4	114x19	677
074		4	114x19	884
075		4	114x19	1091
076		4	114x19	1298
077		4	114x19	1505
078		4	114x19	1713
079		4	114x19	1920
0710		4	114x19	2127
0711		4	114x19	2334
0712		4	114x19	2541
0713		4	114x19	2748
0714		4	114x19	2956
0715		4	114x19	3163
0716		4	114x19	3370
0717		4	114x19	3577
0718		4	114x19	3784
0719		4	114x19	3991
TU44-97R	Door - Tür - Porte - Porta-Puerta 1244x1936	1		
TA44-28R	Window - Fenster - Fenetre - Finestra-Ventana 1003x1336	2		
	  1144x1867mm   903x1236mm			
Code "PAJ44-3535"			Page	3/4

Pos	SPECIFICATION-STÜCKLISTE-NOMENCLATURE-ELEMENTI-ESPECIFICACIÓN "PAJ44-3535"		Pcs	Profile (mm)	Length (mm)
110	Eave edging- Dachrandbrett- Madrier en bordure du toit- Tavola bordo tetto- Tabla de valadizo		4	19x120	4040
156	Slat- Leiste- Baguette- Listello- Listón		1	19x45	1250
170	Roof cap- Dachkappe- Finition métallique- Finitura di tetto- Caballete de tejado		1		
180	Roof element- Dachelement- Panneau de toit- Elemento di tetto- Elemento de tejado		1		
QTihe ndTPE 8mm-1	Seal- Gummidichtung- Joint d'isolation- Guarnizione- Burlate		1	TU44-29R TA44-29R	17000
Fim	-Fixing kit- Befestigungsset- Moyens de fixation- Materiale di fissaggio- Kit de fijación		1	USE	
QPUP 08x80	Bolt -Schloss-schraube -Boulon- Bullone- Perno- M8x80mm PUP0		10	140	
QULSy damik 30/40	Cylinder- Zylinderschloss- Serrure a mortaiser- Serratura a cilindro- Bombin- 30.40		1	TU44-29R	
QULlin kjakate	Door fittings- Türbeschlag- Ferrure- Ferramenta porta- Manilla puerta- QULlinkjakate		1	TU44-29R	
QHaak1 50mmZn	Hook- Haken- Crochet- Ganzio- Pestillo QHaak150mmZn		2	TU44-29R+WALL3	
QServa riiviv astus120	Keeper- Schliessblech- Tole- Lamiera- Aldaba de candado		1	TU44-29R	
QNA1 4x40M	Nail- Nagel- Clou- Chiodo- Clavo- 1.4x40mm		16	130; 131	
QNA2 2x50Zn	Nail- Nagel- Clou- Chiodo- Clavo- 2.5x50mm		700	06x; 07x	
QMU8	Nut- Schraubenmutter- Écrou- Dado- Tuerca- M8mm		10		
QKR2 5 x16kZn	Screw- Schraube- Vis- Vite- Tornillo- 2.5x16mm		2		
QKR3 5x40Zn	Screw- Schraube- Vis- Vite- Tornillo- 3.5x40mm		44	165-167; 110	
QKR3 x20Zn	Screw- Schraube- Vis- Vite- Tornillo- 3x20mm		48	TU44-29R TA44-29R	
QKR4 5x70Zn	Screw- Schraube- Vis- Vite- Tornillo- 4.5x70mm		20	001; 003; 004; 009;...	
QKR5 x90Zn	Screw- Schraube- Vis- Vite- Tornillo- 5x90mm		100	160-164; 168; ... TU44-29R	
QKR6x 120Zn	Screw- Schraube- Vis- Vite- Tornillo- 6x120mm		12	ARx	
QSE8x22	Washer- Dichtscheibe- Joint- Rondella- Arandela- 8x22mm		10		
QALLi nkHOBE	Window fittings- Fenstergriff- Poigne de la fenêtre- Maniglia finestra- Manilla (ventana)		4	TA44-29R	
QAF2 40Zn	Window stop- Fensterfeststelle- Crémaillere- Fissativo finestra- Fijador de ventana- QAF240Zn		4	TA44-29R	
Code	"PAJ44-3535"			Page	4/4

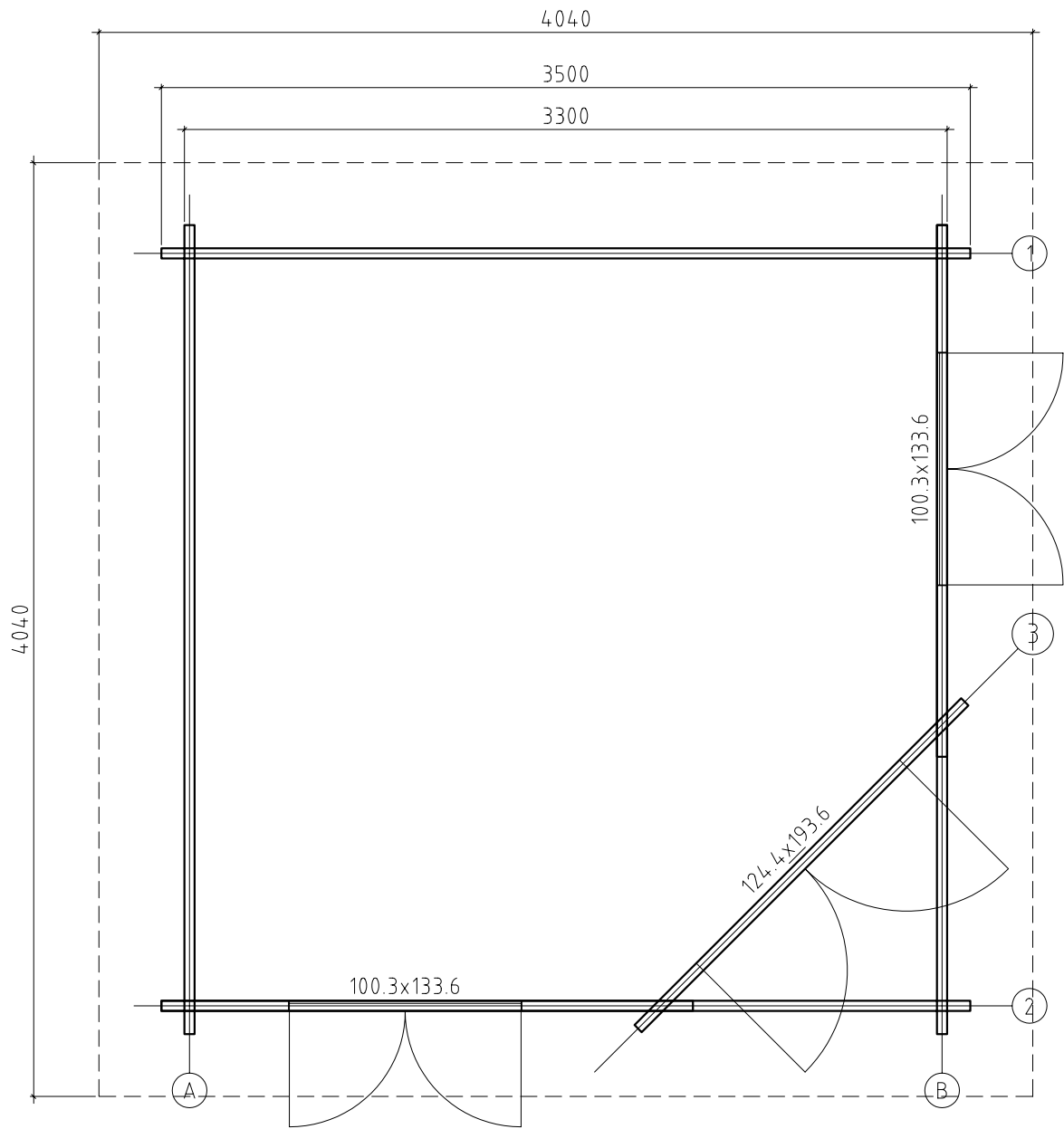

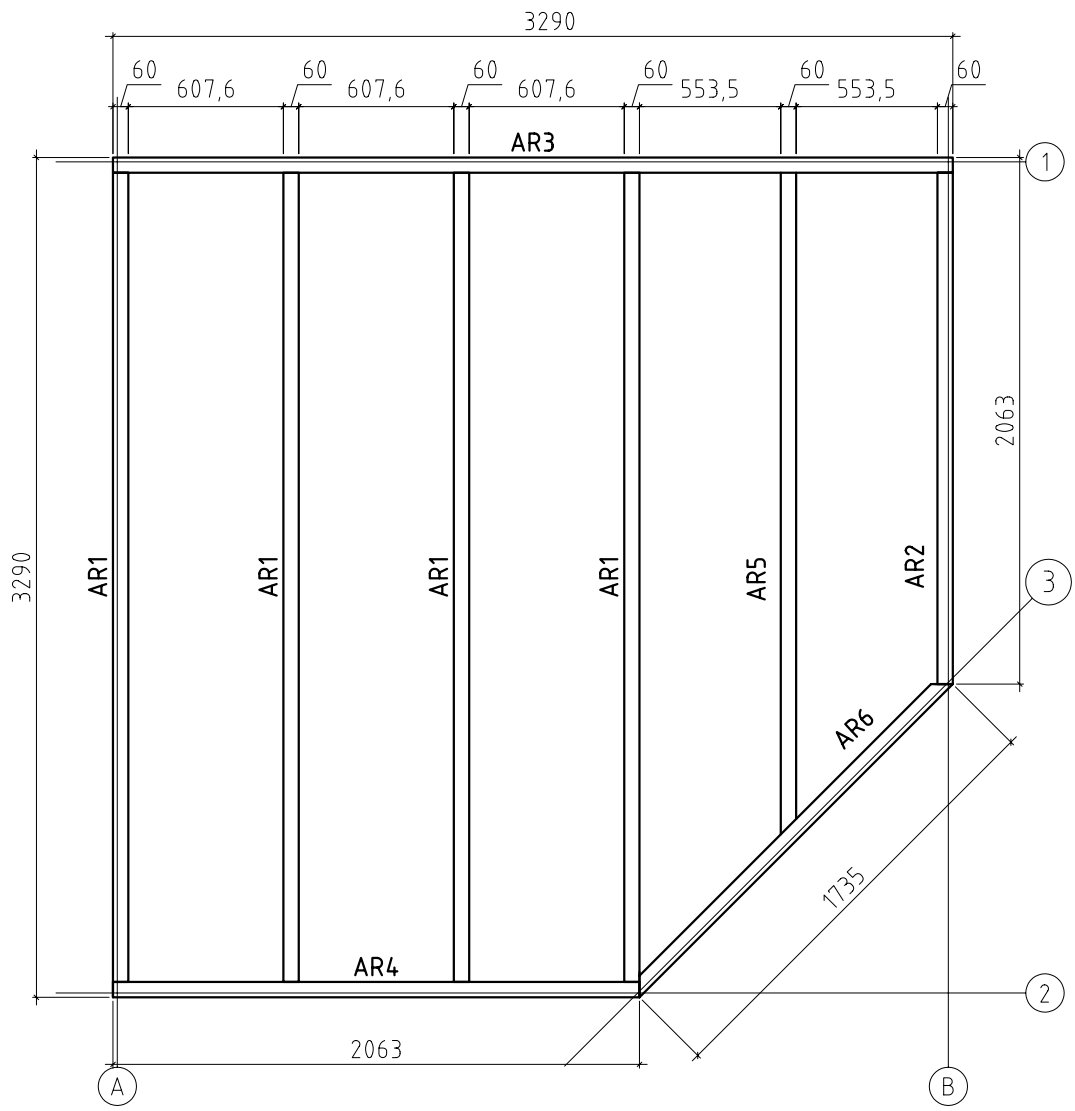

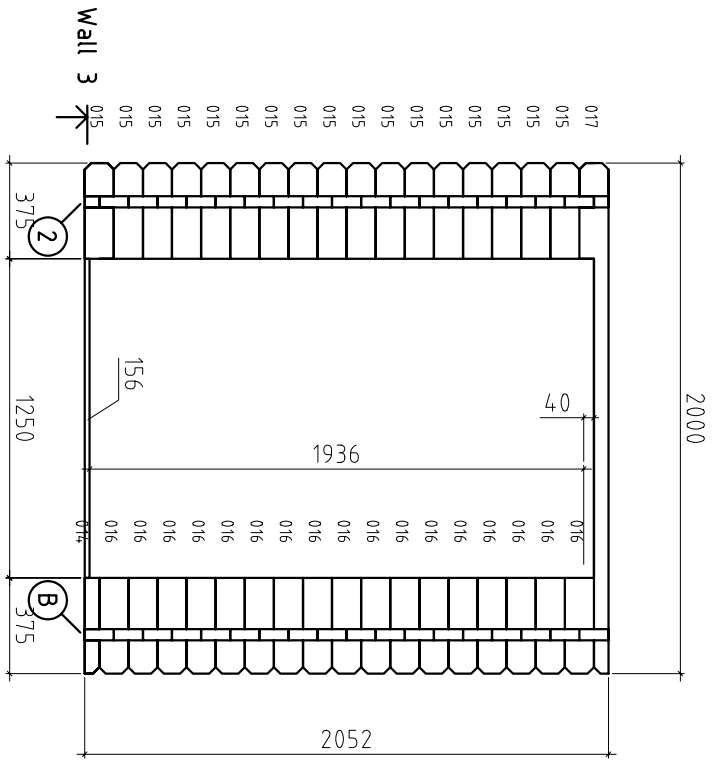

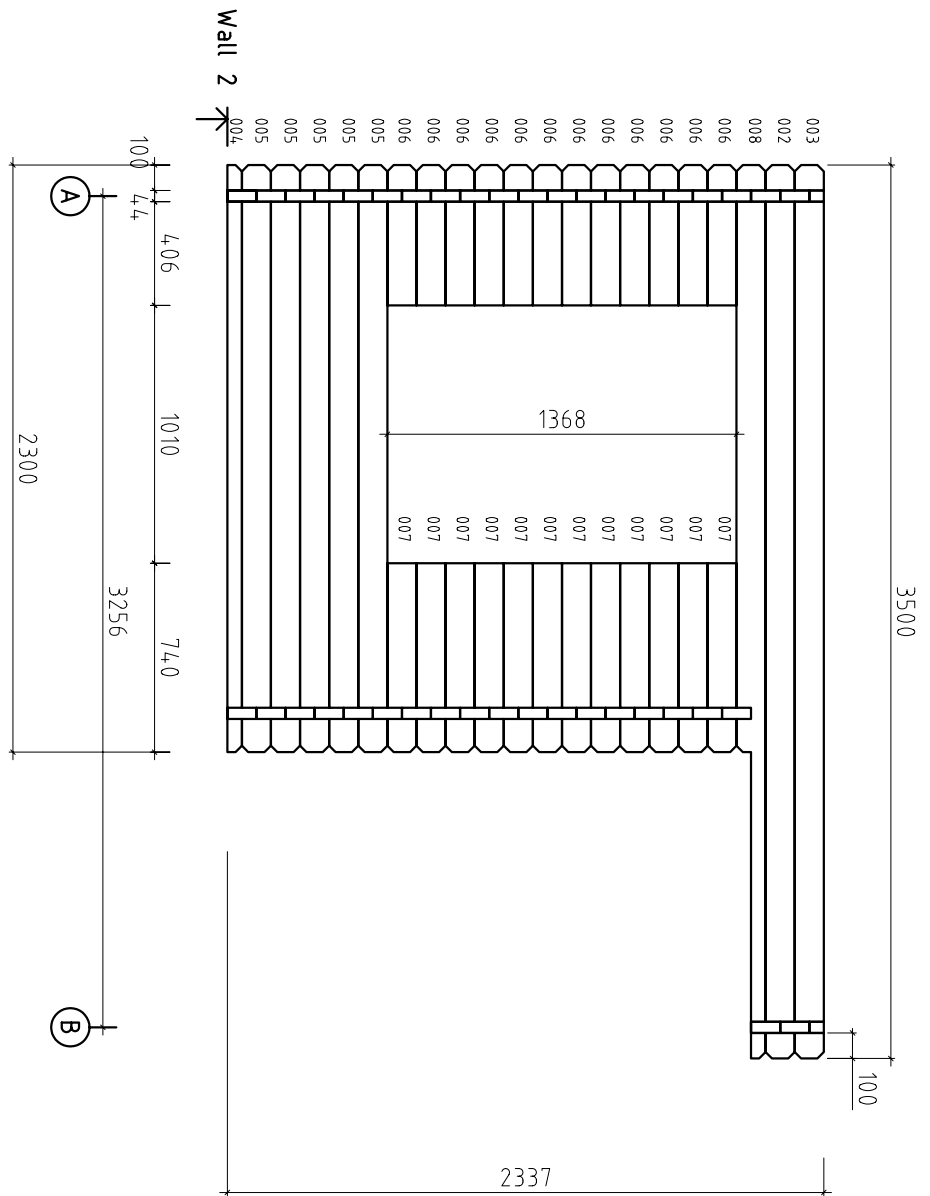

Wall A

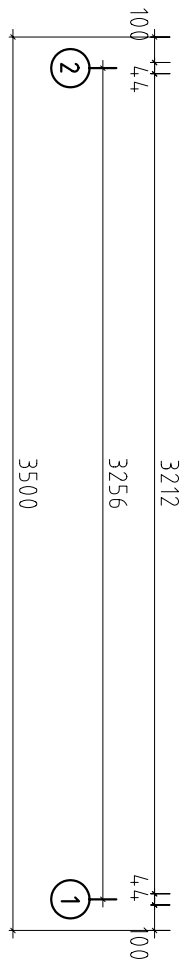
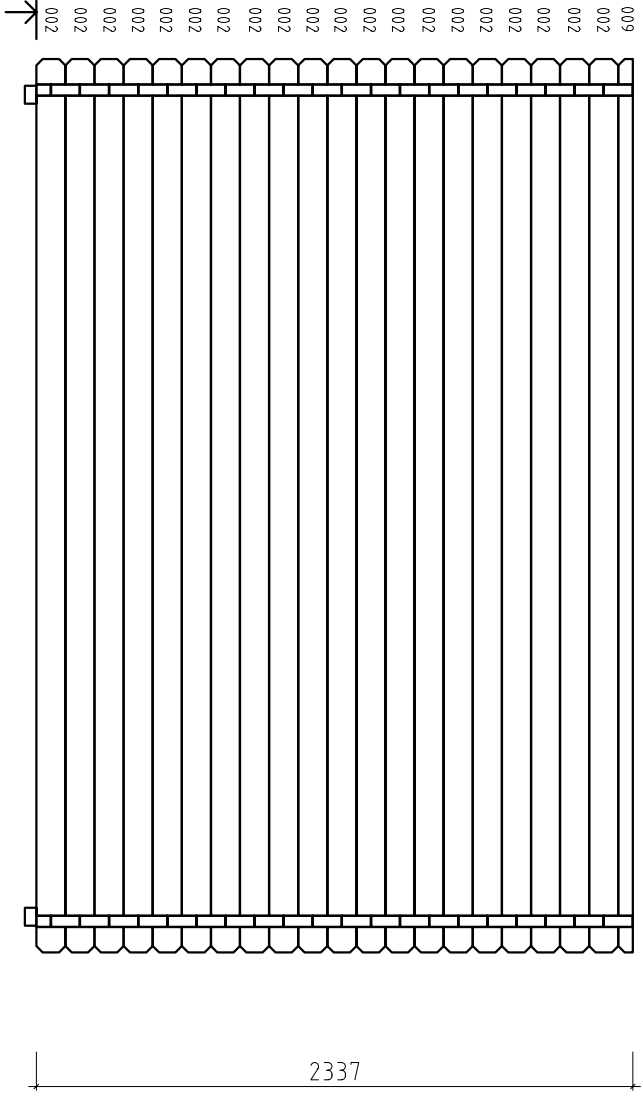

Roof details

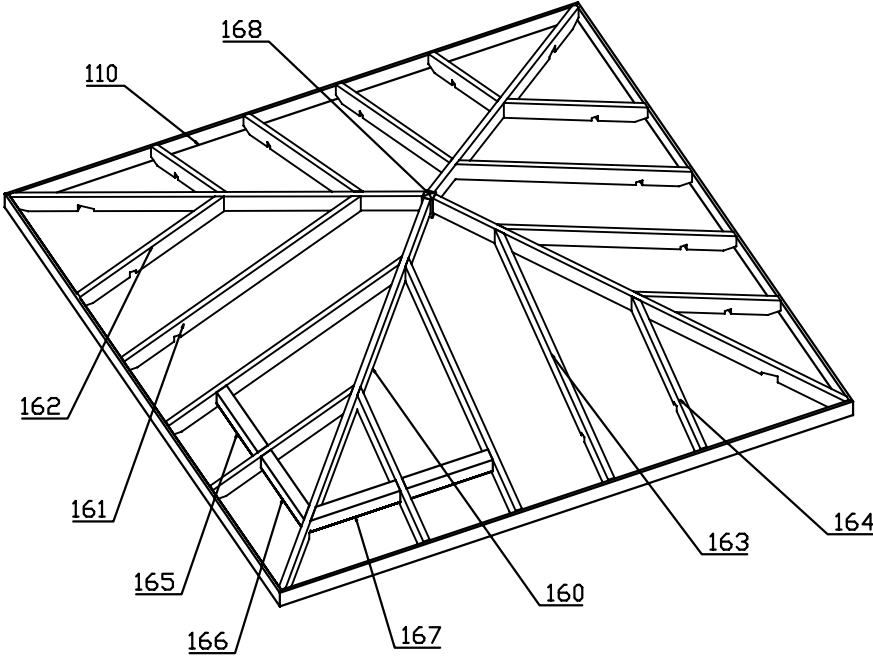

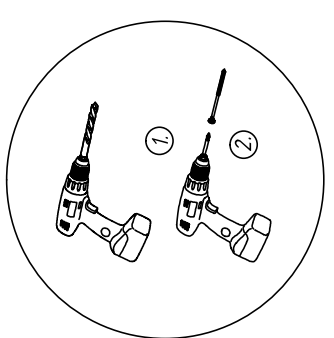
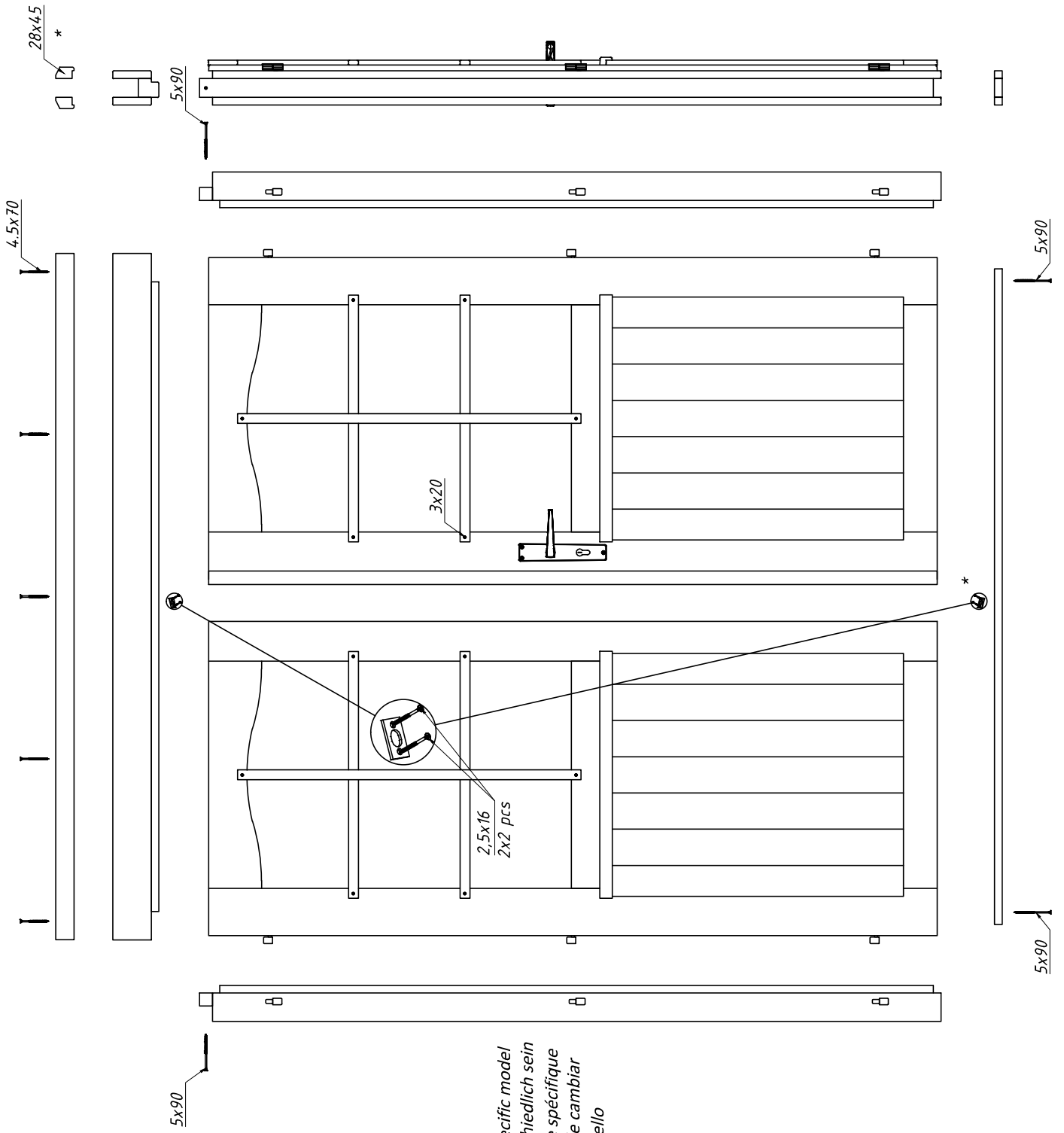

* The specification may vary depending on the specific model
 * Die Spezifikation können je nach Modell unterschiedlich sein
 * Les spécifications peuvent varier selon le modèle spécifique
 * Dependiendo del modelo, la especificación puede cambiar
 * Le specifiche possono variare a seconda del modello